

United States  
Environmental Protection  
Agency

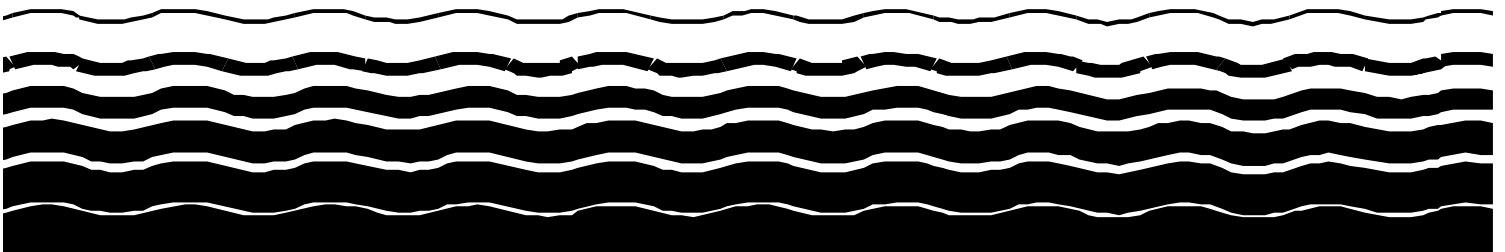
Office of Water  
(4607)

EPA 815-R-99-014  
April 1999



---

# Alternative Disinfectants and Oxidants Guidance Manual





## **DISCLAIMER**

This manual provides accurate technical data and engineering information on disinfectants and oxidants that are not as widely used as chlorine. The U.S. Environmental Protection Agency encourages drinking water treatment utilities and drinking water primacy agencies to examine all aspects of their current disinfection practices to improve the quality of their finished water without reducing microbial protection.

This document is EPA guidance only. It does not establish or affect legal rights or obligation. EPA decisions in any particular case will be made applying the laws and regulation on the basis of specific facts when permits are issued or regulations promulgated.

Mention of trade names or commercial products does not constitute an EPA endorsement or recommendation for use.



## **ACKNOWLEDGMENTS**

The Environmental Protection Agency gratefully acknowledges the assistance of the members of the Microbial and Disinfection Byproducts Federal Advisory Committee and Technical Work Group for their comments and suggestions to improve this document. EPA also wishes to thank the representatives of drinking water utilities, researchers, and the American Water Works Association for their review and comment.



# CONTENTS

<b>1.</b>	<b>INTRODUCTION.....</b>	<b>1-1</b>
1.1	OBJECTIVE OF THIS MANUAL .....	1-1
1.2	BACKGROUND .....	1-2
1.3	REGULATORY CONTEXT .....	1-3
1.3.1	Disinfection Profiling and Benchmarking .....	1-7
1.4	USE OF DISINFECTANTS AS CHEMICAL OXIDANTS.....	1-8
1.5	HOW CHLORINE IS ADDRESSED IN THIS GUIDANCE MANUAL .....	1-8
1.6	A SUMMARY OF ALTERNATIVE DISINFECTANT PROPERTIES.....	1-9
1.7	SELECTING A DISINFECTION STRATEGY .....	1-11
1.7.1	Disinfection Strategy Evaluation .....	1-12
1.7.2	Summary.....	1-17
1.8	REFERENCES.....	1-18
<b>2.</b>	<b>DISINFECTANT USE IN WATER TREATMENT.....</b>	<b>2-1</b>
2.1	NEED FOR DISINFECTION IN WATER TREATMENT .....	2-1
2.1.1	Pathogens of Primary Concern .....	2-2
2.1.2	Recent Waterborne Outbreaks .....	2-8
2.1.3	Mechanism of Pathogen Inactivation .....	2-9
2.2	OTHER USES OF DISINFECTANTS IN WATER TREATMENT .....	2-10
2.2.1	Minimization of DBP Formation .....	2-10
2.2.2	Control of Nuisance Asiatic Clams and Zebra Mussels .....	2-11
2.2.3	Oxidation of Iron and Manganese .....	2-13
2.2.4	Prevention of Regrowth in the Distribution System and Maintenance of Biological Stability.....	2-14
2.2.5	Removal of Taste and Odors Through Chemical Oxidation.....	2-15
2.2.6	Improvement of Coagulation and Filtration Efficiency.....	2-15
2.2.7	Prevention of Algal Growth in Sedimentation Basins and Filters .....	2-16
2.2.8	Removal of Color.....	2-16
2.3	DISINFECTION BYPRODUCTS AND DISINFECTION RESIDUALS .....	2-16
2.3.1	Types of DBPs and Disinfection Residuals.....	2-16
2.3.2	Disinfection Byproduct Formation.....	2-19
2.3.3	DBP Control Strategies .....	2-23
2.3.4	CT Factor.....	2-25
2.4	PATHOGEN INACTIVATION VERSUS DBP FORMATION.....	2-26
2.5	DISINFECTANT RESIDUAL REGULATORY REQUIREMENTS .....	2-27
2.6	SUMMARY OF CURRENT NATIONAL DISINFECTION PRACTICES .....	2-28
2.7	CHLORINE.....	2-30
2.7.1	Chlorine Chemistry .....	2-31
2.7.2	Chlorine Generation .....	2-32
2.7.3	Primary Uses and Points of Application of Chlorine .....	2-33
2.7.4	Pathogen Inactivation and Disinfection Efficacy.....	2-35
2.7.5	DBP Formation and Control.....	2-39
2.7.6	Operational Considerations .....	2-41
2.8	SUMMARY .....	2-42
2.8.1	Advantages and Disadvantages of Chlorine Use .....	2-42
2.8.2	Summary Table.....	2-44
2.8.3	Reference for Additional Information on Chlorine.....	2-44

2.9	REFERENCES.....	2-45
<b>3.</b>	<b>OZONE .....</b>	<b>3-1</b>
3.1	OZONE CHEMISTRY .....	3-1
3.2	OZONE GENERATION .....	3-4
3.2.1	Ozone Production.....	3-4
3.2.2	System Components.....	3-5
3.2.3	Operation and Maintenance.....	3-15
3.3	PRIMARY USES AND POINTS OF APPLICATION OF OZONE .....	3-16
3.3.1	Primary Uses of Ozone.....	3-16
3.3.2	Points of Application.....	3-18
3.3.3	Impact on Other Treatment Processes.....	3-19
3.3.4	Biologically Active Filtration .....	3-19
3.3.5	Pathogen Inactivation and Disinfection Efficacy.....	3-21
3.3.6	Inactivation Mechanisms.....	3-22
3.3.7	Disinfection Parameters.....	3-22
3.3.8	Inactivation of Microorganisms .....	3-24
3.4	OZONATION DISINFECTION BYPRODUCTS .....	3-27
3.4.1	Ozone Byproduct Control.....	3-30
3.5	STATUS OF ANALYTICAL METHODS.....	3-31
3.5.1	Monitoring of Gas Phase Ozone .....	3-31
3.5.2	Monitoring of Liquid Phase Residual Ozone.....	3-35
3.5.3	Bromate Monitoring for Systems Using Ozone.....	3-37
3.6	OPERATIONAL CONSIDERATIONS .....	3-38
3.6.1	Process Considerations.....	3-38
3.6.2	Space Requirements .....	3-38
3.6.3	Material Selection .....	3-39
3.6.4	Ozone System Maintenance.....	3-39
3.6.5	Ozone Safety.....	3-39
3.7	SUMMARY .....	3-41
3.7.1	Advantages and Disadvantages of Ozone Use.....	3-41
3.7.2	Summary Table.....	3-42
3.8	REFERENCES.....	3-43
<b>4.</b>	<b>CHLORINE DIOXIDE.....</b>	<b>4-1</b>
4.1	CHLORINE DIOXIDE CHEMISTRY .....	4-1
4.1.1	Oxidation Potential.....	4-1
4.2	GENERATION .....	4-2
4.2.1	Introduction .....	4-2
4.2.2	Chlorine Dioxide Purity .....	4-3
4.2.3	Methods of Generating Chlorine Dioxide .....	4-4
4.2.4	Generator Design .....	4-9
4.2.5	Chemical Feed Systems.....	4-11
4.2.6	Generator Power Requirements .....	4-13
4.3	PRIMARY USES AND POINTS OF APPLICATION FOR CHLORINE DIOXIDE.....	4-13
4.3.1	Disinfection .....	4-13
4.3.2	Taste and Odor Control .....	4-14
4.3.3	Oxidation of Iron and Manganese.....	4-14
4.4	PATHOGEN INACTIVATION AND DISINFECTION EFFICACY .....	4-15
4.4.1	Inactivation Mechanisms.....	4-15
4.4.2	Environmental Effects.....	4-15

4.4.3	Disinfection Efficacy.....	4-17
4.5	CHLORINE DIOXIDE DISINFECTION BYPRODUCTS.....	4-22
4.5.1	Production of Chlorite and Chlorate .....	4-22
4.5.2	Organic DBPs Produced by Chlorine Dioxide.....	4-25
4.5.3	Chlorine Dioxide DBP Control Strategies.....	4-25
4.6	STATUS OF ANALYTICAL METHODS.....	4-26
4.6.1	Chlorine Dioxide and Chlorite Analytical Methods.....	4-27
4.6.2	Chlorine Dioxide Monitoring for Systems Using Chlorine Dioxide.....	4-27
4.6.3	Chlorite Monitoring for Systems Using Chlorine Dioxide.....	4-28
4.7	OPERATIONAL CONSIDERATIONS .....	4-28
4.7.1	Process Considerations.....	4-30
4.7.2	Generator Operation.....	4-31
4.7.3	Feed Chemicals.....	4-31
4.8	SUMMARY .....	4-33
4.8.1	Advantages and Disadvantages of Chlorine Dioxide Use .....	4-33
4.8.2	Summary Table.....	4-34
4.9	REFERENCES.....	4-35
<b>5.</b>	<b>POTASSIUM PERMANGANATE .....</b>	<b>5-1</b>
5.1	POTASSIUM PERMANGANATE CHEMISTRY .....	5-1
5.1.1	Oxidation Potential.....	5-1
5.1.2	Ability to Form a Residual .....	5-1
5.2	GENERATION .....	5-1
5.3	PRIMARY USES AND POINTS OF APPLICATION .....	5-2
5.3.1	Primary Uses.....	5-2
5.3.2	Points of Application.....	5-4
5.4	PATHOGEN INACTIVATION AND DISINFECTION EFFICACY .....	5-4
5.4.1	Inactivation Mechanisms.....	5-4
5.4.2	Environmental Effects.....	5-5
5.4.3	Use as a Disinfectant .....	5-5
5.5	DISINFECTION BYPRODUCT FORMATION.....	5-7
5.5.1	Chapel-Hill and Durham, North Carolina Water Treatment Plants .....	5-7
5.5.2	American Water Works Association Research Foundation TTHM Study.....	5-9
5.6	STATUS OF ANALYTICAL METHODS.....	5-9
5.7	OPERATIONAL CONSIDERATIONS .....	5-9
5.8	SUMMARY .....	5-10
5.8.1	Advantages and Disadvantages of Potassium Permanganate Use .....	5-10
5.8.2	Summary Table.....	5-11
5.9	REFERENCES.....	5-12
<b>6.</b>	<b>CHLORAMINES .....</b>	<b>6-1</b>
6.1	CHLORAMINES CHEMISTRY .....	6-1
6.1.1	Equilibrium, Kinetic, and Physiochemical Properties.....	6-1
6.2	GENERATION .....	6-3
6.2.1	Chlorine Feed Facilities.....	6-4
6.2.2	Ammonia Feed Facilities.....	6-5
6.3	PRIMARY USES AND POINTS OF APPLICATION .....	6-10
6.3.1	Primary Uses.....	6-10
6.3.2	Points of Application.....	6-11
6.4	PATHOGEN INACTIVATION AND DISINFECTION EFFICACY .....	6-12
6.4.1	Inactivation Mechanisms.....	6-12

6.4.2	Environmental Effects.....	6-12
6.4.3	Disinfection Efficacy.....	6-13
6.5	DBP FORMATION.....	6-15
6.6	STATUS OF ANALYTICAL METHODS.....	6-16
6.6.1	Monitoring of Chloramines.....	6-16
6.6.2	Disinfectant Interferences.....	6-17
6.6.3	Chloramine Monitoring for Systems Using Chloramines.....	6-19
6.7	OPERATIONAL CONSIDERATIONS.....	6-20
6.7.1	Conversion to Chloramination from Chlorination.....	6-20
6.7.2	Potential Operational Impacts from Chloramination Disinfection.....	6-22
6.7.3	Special Considerations for Chloramination Facilities.....	6-25
6.8	SUMMARY.....	6-27
6.8.1	Advantages and Disadvantages of Chloramine Use.....	6-27
6.8.2	Summary Table.....	6-28
6.9	REFERENCES.....	6-29
<b>7.</b>	<b>PEROXONE (OZONE/HYDROGEN PEROXIDE).....</b>	<b>7-1</b>
7.1	PEROXONE CHEMISTRY.....	7-1
7.1.1	Oxidation Reactions.....	7-2
7.1.2	Reactions with Other Water Quality Parameters.....	7-3
7.1.3	Comparison between Ozone and Peroxone.....	7-3
7.2	GENERATION.....	7-4
7.3	PRIMARY USES AND POINTS OF APPLICATION.....	7-5
7.3.1	Primary Uses.....	7-5
7.3.2	Points of Application.....	7-6
7.4	PATHOGEN INACTIVATION.....	7-6
7.4.1	Inactivation Mechanism.....	7-6
7.4.2	Environmental Effects.....	7-7
7.4.3	Disinfection Efficacy and Pathogen Inactivation.....	7-8
7.5	DISINFECTION BYPRODUCTS.....	7-9
7.6	STATUS OF ANALYTICAL METHODS.....	7-10
7.6.1	Monitoring of Hydrogen Peroxide.....	7-10
7.7	OPERATIONAL CONSIDERATIONS.....	7-13
7.7.1	Process Considerations.....	7-13
7.7.2	Space Requirements.....	7-13
7.7.3	Materials.....	7-13
7.8	SUMMARY.....	7-14
7.8.1	Advantages and Disadvantages of Peroxone Use (Ozone/Hydrogen Peroxide).....	7-14
7.8.2	Summary Table.....	7-15
7.9	REFERENCES.....	7-16
<b>8.</b>	<b>ULTRAVIOLET RADIATION.....</b>	<b>8-1</b>
8.1	UV CHEMISTRY (PHOTOCHEMICAL).....	8-1
8.1.1	UV Radiation.....	8-1
8.1.2	UV Disinfection Reactions.....	8-2
8.1.3	Process Variables.....	8-2
8.2	GENERATION.....	8-3
8.2.1	UV Lamps.....	8-4
8.2.2	Ballasts.....	8-4
8.2.3	UV Reactor Design.....	8-5
8.3	PRIMARY USES AND POINTS OF APPLICATION.....	8-8

8.4	PATHOGEN INACTIVATION AND DISINFECTION EFFICIENCY .....	8-8
8.4.1	Inactivation Mechanism .....	8-8
8.4.2	Environmental Effects.....	8-10
8.4.3	Disinfection Efficacy.....	8-12
8.5	DISINFECTION BYPRODUCTS OF UV RADIATION .....	8-15
8.5.1	Ground Water .....	8-15
8.5.2	Surface Water .....	8-16
8.5.3	DBP Formation with Chlorination and Chloramination following UV Radiation.....	8-16
8.6	STATUS OF ANALYTICAL METHODS.....	8-17
8.6.1	Monitoring of Generated Ultraviolet Radiation.....	8-17
8.6.2	Disinfectant Interferences.....	8-18
8.7	OPERATIONAL CONSIDERATIONS .....	8-18
8.7.1	Equipment Operation .....	8-19
8.7.2	Equipment Maintenance.....	8-19
8.7.3	Standby Power .....	8-20
8.8	SUMMARY TABLE.....	8-21
8.9	REFERENCES.....	8-21
<b>9.</b>	<b>COMBINED DISINFECTANTS.....</b>	<b>9-1</b>
9.1	PRIMARY AND SECONDARY DISINFECTANTS .....	9-1
9.1.1	DBP Formation with Various Primary and Secondary Disinfectant Combinations .....	9-3
9.1.2	Impact of Modifying Disinfection Practices.....	9-6
9.1.3	Chlorine/Chlorine to Chlorine/Chloramine .....	9-8
9.1.4	Chlorine/Chlorine to Ozone/Chlorine .....	9-8
9.1.5	Chlorine/Chlorine to Ozone/Chloramine.....	9-9
9.1.6	Chlorine/Chlorine to Chlorine Dioxide/Chlorine.....	9-9
9.1.7	Chlorine/Chlorine to Chlorine Dioxide/Chlorine Dioxide.....	9-10
9.1.8	Chlorine/Chloramine to Ozone/Chloramine .....	9-10
9.1.9	Chlorine/Chloramine to Chlorine Dioxide/Chloramine .....	9-10
9.1.10	Ozone/Chlorine to Ozone/Chloramine .....	9-11
9.1.11	Summary.....	9-11
9.2	PATHOGEN INACTIVATION WITH INTERACTIVE DISINFECTANTS .....	9-11
9.2.1	Inactivation Mechanism .....	9-12
9.2.2	Environmental Effects.....	9-13
9.2.3	Pathogen Inactivation Efficiency Using Interactive Disinfectants.....	9-16
9.2.4	Summary: Pathogen Inactivation with Interactive Disinfectants .....	9-23
9.3	ANALYTICAL METHODS.....	9-23
9.3.1	Ozone .....	9-23
9.3.2	Chlorine Dioxide.....	9-24
9.3.3	Potassium Permanganate .....	9-24
9.3.4	Chloramine .....	9-24
9.3.5	Hydrogen Peroxide.....	9-24
9.3.6	UV Radiation .....	9-24
9.3.7	Summary of Analytical Methods .....	9-24
9.4	SUMMARY .....	9-25
9.5	REFERENCES.....	9-26
	<b>APPENDIX A. SUMMARY OF DISINFECTANT USAGE IN THE UNITED STATES .....</b>	<b>A-1</b>
	<b>APPENDIX B. SELECTED COSTS OF ALTERNATIVE DISINFECTION SYSTEMS.....</b>	<b>B-1</b>

## FIGURES

Figure 1-1. Flow Diagram to Evaluate Current Disinfection Practices .....	1-14
Figure 1-2. Flow Diagram to Narrow Selection of a New Primary Disinfectant .....	1-16
Figure 1-3. Flow Diagram to Narrow Selection of a New Secondary Disinfectant .....	1-17
Figure 2-1. Free Chlorine <i>Giardia</i> and Virus CT Requirements .....	2-38
Figure 2-2. CT Values for Inactivation of <i>Giardia</i> Cysts by Free Chlorine at 10°C (at Cl <sub>2</sub> dose of 3.0 mg/L).....	2-38
Figure 2-3. CT Values for Inactivation of <i>Giardia</i> Cysts by Free Chlorine at pH 7.0 (at Cl <sub>2</sub> dose of 3.0 mg/L).....	2-39
Figure 3-1. Oxidation Reactions of Compounds (Substrate) During Ozonation of Water .....	3-2
Figure 3-2. Reaction of Ozone and Bromide Ion Can Produce Bromate Ion and Brominated Organics .....	3-3
Figure 3-3. Basic Ozone Generator .....	3-4
Figure 3-5. Schematic of an Air Preparation System.....	3-7
Figure 3-6. Cylindrical Electrode Schematic .....	3-9
Figure 3-7. Ozone Bubble Contactor .....	3-11
Figure 3-8. Sidestream Ozone Injection System .....	3-12
Figure 3-9. Turbine Mixer Ozone Contactor.....	3-14
Figure 3-10. CT Values for Inactivation of Viruses by Ozone (pH 6 to 9).....	3-26
Figure 3-11. Principal Reactions Producing Ozone Byproducts .....	3-28
Figure 3-12. Main Pathways of Bromate Ion Formation when Ozone Reacts with Bromide Ion.....	3-30
Figure 4-1. Conventional Chlorine Dioxide Generator When Using Chlorine-Chlorite Method .....	4-7
Figure 4-2. Chlorine Dioxide Generation Using Recycled Aqueous Chlorine Method .....	4-8
Figure 4-3. Effect of Temperature on <i>N. Gruberi</i> Cyst Inactivation at pH 7 .....	4-17
Figure 4-4. Comparison of Germicidal Efficiency of Chlorine Dioxide and Chlorine.....	4-19
Figure 4-5. CT Values for Inactivation of <i>Giardia</i> Cysts by Chlorine Dioxide .....	4-21
Figure 4-6. CT Values for Inactivation of Viruses by Chlorine Dioxide.....	4-22
Figure 4-7. <i>C. parvum</i> Inactivation by Chlorine Dioxide at 20°C.....	4-23
Figure 4-8. <i>C. parvum</i> Inactivation by Chlorine Dioxide at 10°C.....	4-23
Figure 6-1. Theoretical Breakpoint Curve .....	6-2
Figure 6-2. Distribution Diagram for Chloramine Species with pH.....	6-3
Figure 6-3. Gaseous Chlorine Feed System .....	6-5
Figure 6-4. Hypochlorite Feed System .....	6-6
Figure 6-5. Anhydrous Ammonia Direct Feed System.....	6-7
Figure 6-6. Anhydrous Ammonia Solution Feed System .....	6-8
Figure 6-7. Aqua Ammonia Feed System .....	6-9
Figure 8-1. Closed Vessel Ultraviolet Reactor.....	8-6
Figure 8-2. Germicidal Inactivation by UV Radiation.....	8-9
Figure 8-3. UV Dose Required for Inactivation of MS-2 Coliphage.....	8-11
Figure 8-4. Particle Interactions that Impact UV Effectiveness .....	8-12
Figure 8-5. UV Doses Required to Achieve Inactivation of <i>Giardia lamblia</i> Cysts Obtained from Two Different Sources .....	8-14
Figure 8-6. Impact of Growth Stage of <i>A. rhysodes</i> on the Required UV Dosage to Achieve Inactivation.....	8-14
Figure 9-1. Inactivation of <i>C. parvum</i> Attributed to Synergistic Effects. Application of Ozone Followed by Chlorine Dioxide .....	9-14
Figure 9-2. Inactivation of <i>C. parvum</i> Attributed to Synergistic Effects. Application of	

Chlorine Dioxide Followed by Free Chlorine .....	9-14
Figure 9-3. Inactivation of <i>C. parvum</i> Attributed to Synergistic Effects. Application of Chlorine Dioxide Followed by Monochloramine.....	9-15
Figure 9-4. Inactivation of <i>E. coli</i> Using Free Chlorine and Monochloramine.....	9-18

## TABLES

Table 1-1. Key Dates for Regulatory Activities .....	1-4
Table 1-2. Primary Drinking Water Regulations Related to Microbiological Contaminants.....	1-6
Table 1-3. Primary Drinking Water Regulations Related to Disinfection Byproducts.....	1-6
Table 1-4. Primary Drinking Water Regulations Related to Residual Disinfectants.....	1-7
Table 1-5. Log Removal/Inactivation through Filtration and Disinfection Required Under the SWTR.....	1-7
Table 1-6. Summary of Disinfectant Properties (Based on Typical Disinfectant Application).....	1-11
Table 2-1. Waterborne Diseases from Bacteria.....	2-3
Table 2-2. Waterborne Diseases from Human Enteric Viruses.....	2-4
Table 2-3. Waterborne Diseases from Parasites.....	2-6
Table 2-4. Attributes of the Three Waterborne Pathogens of Concern in Water Treatment .....	2-7
Table 2-5. Human Parasitic Protozoans .....	2-7
Table 2-6. The Effects of Various Oxidants on Mortality of the Asiatic Clam ( <i>Corbicula fluminea</i> ) .....	2-12
Table 2-7. Oxidant Doses Required for Oxidation of Iron and Manganese.....	2-14
Table 2-8. List of Disinfection Byproducts and Disinfection Residuals.....	2-17
Table 2-9. Status of Health Information for Disinfectants and DBPs.....	2-18
Table 2-10. Conditions of Formation of DBPs.....	2-22
Table 2-11. Inorganic DBPs Produced During Disinfection.....	2-23
Table 2-12. Required Removal of TOC by Enhanced Coagulation for Surface Water Systems Using Conventional Treatment (percent reduction).....	2-25
Table 2-13. CT Values for Inactivation of Viruses.....	2-26
Table 2-14. CT Values for Inactivation of <i>Giardia</i> Cysts.....	2-26
Table 2-15. Summary of Disinfection Impacts .....	2-27
Table 2-16. Disinfection Practices of Water Systems that Include Some Form of Treatment .....	2-29
Table 2-17. Ozone Application in Water Treatment Plants in the United States .....	2-30
Table 2-18. Chlorine Uses and Doses.....	2-34
Table 2-19. Typical Chlorine Points of Application and Uses.....	2-34
Table 2-20. Typical Chlorine Dosages at Water Treatment Plants.....	2-35
Table 2-21. Percent Reduction in DBP Formation by Moving Chlorination Point Later In Treatment Train.....	2-40
Table 2-22. Summary of Chlorine Disinfection .....	2-44
Table 3-1. Types of Compressors Used in Air Preparation Systems.....	3-7
Table 3-2. Comparison of Air and High Purity Oxygen Feed Systems.....	3-8
Table 3-3. Comparison of Primary Characteristics of Low, Medium, and High Frequency Ozone Generators.....	3-10
Table 3-4. Bubble Diffuser Contactor Advantages and Disadvantages.....	3-12
Table 3-5. Injection Contacting Advantages and Disadvantages .....	3-13
Table 3-6. Turbine Mixer Contactor Advantages and Disadvantages .....	3-14

Table 3-7. Criteria for Selecting Ozone Feed Points for Small Systems .....	3-18
Table 3-8. Summary of Reported Ozonation Requirements for 99 Percent Inactivation of <i>Cryptosporidium Oocysts</i> .....	3-27
Table 3-9. Principal Known Byproducts of Ozonation.....	3-28
Table 3-10. Characteristics and Comparisons of Gas-Phase Ozone Analytical Methods.....	3-33
Table 3-11. Characteristics and Comparisons of Residual Ozone Analytical Methods.....	3-36
Table 3-12. Summary of Ozone Disinfection Considerations.....	3-42
Table 4-1. Commercial Chlorine Dioxide Generators .....	4-5
Table 4-2. Surface Water Chlorine Dioxide Demand Study Results.....	4-14
Table 4-3. Analytical Methods for Chlorine Dioxide and Related Compounds.....	4-30
Table 4-4. Properties of Sodium Chlorite as Commercially Available.....	4-32
Table 4-5. Summary for Chlorine Dioxide .....	4-34
Table 5-1. Potassium Permanganate CT Values for 2-log Inactivation of MS-2 Bacteriophage.....	5-7
Table 5-2. Summary of Potassium Permanganate Use .....	5-12
Table 6-1. Chlorine Dose Required for NH <sub>3</sub> - Cl <sub>2</sub> Reaction .....	6-3
Table 6-2. Time to 99 Percent Conversion of Chlorine to Monochloramine .....	6-4
Table 6-3. Methods of Chlorine Addition .....	6-4
Table 6-4. CT Values for <i>Giardia</i> Cyst Inactivation Using Chloramines.....	6-15
Table 6-5. CT Values for Virus Inactivation Using Chloramines .....	6-15
Table 6-6. Characteristics and Comparisons of Monochloramine Analytical Methods .....	6-18
Table 6-7. Survey of Chloramine Users in the United States.....	6-25
Table 6-8. Summary of Chloramine Disinfection .....	6-29
Table 7-1. Comparison Between Ozone and Peroxone Oxidation .....	7-4
Table 7-2. Calculated CT Values (Mg•Min/L) for the Inactivation of <i>Giardia Muris</i> .....	7-8
Table 7-3. Characteristics and Comparisons of Hydrogen Peroxide Analytical Methods .....	7-12
Table 7-4. Summary of Peroxone Disinfection Consideration.....	7-15
Table 8-1. Water Quality and Associated UV Measurements.....	8-3
Table 8-2. Doses Required for MS-2 Inactivation.....	8-13
Table 8-3. Summary of UV Disinfection .....	8-21
Table 9-1. Potential Primary Disinfectants .....	9-2
Table 9-2. Primary/Secondary Disinfectant Combinations and Typical Applications in Water Treatment.....	9-3
Table 9-3. DBPs Associated with Various Combined Oxidation/Disinfection Processes .....	9-4
Table 9-4. Strategies for Primary and Secondary Disinfectants.....	9-6
Table 9-5. Impacts of Disinfection Practice on DBP Formation.....	9-7
Table 9-6. Virus Inactivation By Individual Disinfectants and Simultaneous Chloramination.....	9-17
Table 9-7. <i>C. parvum</i> Inactivation Using Ozone Followed by Chlorine Dioxide .....	9-19
Table 9-8. <i>C. parvum</i> Inactivation Using Chlorine Dioxide Followed by Free Chlorine .....	9-19
Table 9-9. <i>G. muris</i> Inactivation Using Chlorine Dioxide Followed by Free Chlorine.....	9-19
Table 9-10. <i>B. cereus</i> Inactivation Using Chlorine Dioxide Followed by Free Chlorine .....	9-19
Table 9-11. <i>C. parvum</i> Inactivation Using Chlorine Dioxide Followed by Chloramine .....	9-20
Table 9-12. <i>G. muris</i> Inactivation Using Chlorine Dioxide Followed by Chloramine .....	9-20
Table 9-13. <i>G. muris</i> Inactivation Using Ozone Followed by Free Chlorine.....	9-21
Table 9-14. <i>B. cereus</i> Inactivation Using Chlorine Dioxide Followed by Free Chlorine .....	9-21
Table 9-15. <i>G. muris</i> Inactivation Using Ozone Followed by Chloramine.....	9-21
Table 9-16. <i>G. muris</i> Inactivation by Free Chlorine Followed by Monochloramine.....	9-22
Table 9-17. <i>C. parvum</i> Inactivation by Sequential Application of Ozone and Chloramine.....	9-22

Table 9-18. Summary of Combined Disinfectants .....	9-25
---	------

## ACRONYMS

AECL	Alternate enhanced coagulant level
ACUK	Acid chrome violet K
AOC	Assimilable organic carbon
ASDWA	Association of State Drinking Water Administrators
AWWA	American Water Works Association
AWWARF	AWWA Research Foundation
BAC	Biologically active carbon
BAF	Biologically active filtration
BAT	Best Available Technology
BCAA	Bromochloroacetic acid
BDOC	Biodegradable organic carbon
BMP	Best management practice
BOM	Biodegradable Organic Matter (=BDOC + AOC)
Br-	Bromide ion
BrO <sub>2</sub> -	Bromite ion
BrO <sub>3</sub> -	Bromate ion
CI	Confidence interval
Cl <sub>2</sub>	Chlorine
ClO <sub>2</sub>	Chlorine Dioxide
CT	Concentration-Time
CWS	Community Water System
D/DBP	Disinfectants/disinfection byproducts
DBPR	Disinfectants/disinfection byproducts rule
DBP	Disinfection byproduct
DBPFP	Disinfection byproduct formation potential
DBPP	Disinfection byproduct precursors
DBPRAM	DBP Regulatory Assessment Model
DBPs	Disinfection byproducts
DOC	Dissolved organic carbon
DPD	N,N-diethyl-p-phenylenediamine
DWEL	Drinking Water Equivalent Level
EBCT	Empty bed contact time
EMSL	EPA Environmental Monitoring and Support Laboratory (Cincinnati)
EPA	United States Environmental Protection Agency
ESWTR	Enhanced Surface Water Treatment Rule
FBR	Filter Backwash Rule
FY	Fiscal year
GAC	Granular activated carbon
GWR	Ground Water Rule
GWSS	Ground Water Supply Survey
H <sub>2</sub> O <sub>2</sub>	Hydrogen Peroxide
HAA <sub>5</sub>	Haloacetic acids (five)
HOBr	Hypobromous acid
HOCl	Hypochlorous acid
IC	Ion chromatography

ICR	Information Collection Rule
IESWTR	Interim Enhanced Surface Water Treatment Rule
IOA	International Ozone Association
IOC	Inorganic chemical
KMnO <sub>4</sub>	Potassium permanganate
LOAEL	Lowest observed adverse effect level
LOQ	Limit of quantitation
LT1ESWTR	Long Term Stage 1 Enhanced Surface Water Treatment Rule
M-DBP	Microbial and disinfection byproducts
MCL	Maximum Contaminant Level
MCLG	Maximum Contaminant Level Goal
MDL	Method Detection Limit
mg/L	Milligrams per liter
mgd	Million gallons per day
MIB	Methylisoborneol
MRDL	Maximum Residual Disinfectant Level (as mg/l)
MRDLG	Maximum Residual Disinfectant Level Goal
MRL	Minimum Reporting Level
MX	3-chloro-4-(dichloromethyl)-5-hydroxyl-2(5H)-furanone
NaCl	Sodium chloride
NCI	National Cancer Institute
ND	Not detected
NH <sub>2</sub> Cl	Monochloramine
NIPDWR	National Interim Primary Drinking Water Regulation
NIOSH	National Institute for Occupational Safety and Health
NOAEL	No Observed Adverse Effect Level
NOM	Natural Organic Matter
NOMS	National Organic Monitoring Survey
NORS	National Organics Reconnaissance Survey for Halogenated Organics
NPDWR	National Primary Drinking Water Regulation
NTNCWS	Nontransient noncommunity water system
NTP	Normal Temperature and Pressure
O <sub>2</sub>	Oxygen
O <sub>3</sub>	Ozone
OBr-	Hypobromite ion
OCI-	Hypochlorite ion
PCE	Perchloroethylene
PE	Performance evaluation
POE	Point-of-Entry Technologies
POU	Point-of-Use Technologies
ppb	Parts per billion
ppm	Parts per million
PQL	Practical Quantitation Level
PTA	Packed Tower Aeration
PWS	Public water system
RIA	Regulatory Impact Analysis
RMCL	Recommended Maximum Contaminant Level
RNDB	Regulations Negotiation Data Base
RSC	Relative Source Contribution
SDWA	Safe Drinking Water Act, or the "Act," as amended in 1996
SM	Standard Method

---

SMCL	Secondary Maximum Contaminant Level
SMR	Standardized mortality ratios
SOC	Synthetic Organic Chemical
SWTR	Surface Water Treatment Rule
TCE	Trichloroethylene
THM	Trihalomethane
THMFP	Trihalomethane formation potential
TMV	Tobacco mosaic virus
TOC	Total organic carbon
TTHM	Total trihalomethanes
TWG	Technologies Working Group
UV	Ultraviolet
VOC	Volatile Organic Chemical
WIDB	Water Industry Data Base
WS	Water supply
XDBPs	Halogenated DBPs

THIS PAGE INTENTIONALLY LEFT BLANK

# 1. INTRODUCTION

---

## 1.1 Objective of this Manual

Chlorine is, by far, the most commonly used disinfectant in the drinking water treatment industry (Sawyer et al., 1994). Today, chlorine is used as a primary disinfectant in the vast majority of all surface water treatment plants, being used as a pre-disinfectant in more than 63 percent and as a post-disinfectant in more than 67 percent of all surface water treatment plants (USEPA, 1997). This manual is organized to provide technical data and engineering information on disinfectants that are not as widely used as chlorine. Also, where applicable, this document describes the use of these disinfectants as oxidants and any associated implications.

The U.S. Environmental Protection Agency (EPA) encourages utilities to examine all aspects of their current disinfection practices to identify opportunities to improve the quality of the finished water without reducing microbial protection. The objective of this guidance manual is to describe alternative disinfectants and disinfection techniques that may be used to comply with both the **Stage 1 Disinfectants and Disinfection Byproducts Rule (DBPR) and Interim Enhanced Surface Water Treatment Rule (IESWTR)** and highlight advantages and disadvantages of their use.

EPA is not recommending that utilities employ the disinfectants and oxidants discussed in this manual, nor is it advocating that utilities switch from one disinfectant or oxidant to another. EPA acknowledges that selection of the most appropriate disinfection technique is a site-specific decision best left to utility personnel and state agencies. Utilities should use this guidance as an information resource to assist in the selection of appropriate disinfectants and disinfectant schemes to meet their specific goals. Extensive bench and/or pilot scale testing and a thorough review of regulatory requirements should precede changes to disinfection practice. Systems should refer to the *Guidance Manual for Compliance with the Filtration and Disinfection Requirements for Public Works Systems Using Surface Water Sources* (AWWA, 1991) to ensure disinfectant schemes meet regulatory log inactivation requirements. Utilities should also refer to EPA's *Disinfection Profiling and Benchmarking Guidance Manual* (currently in production) to ensure compliance with the new regulatory requirements of the IESWTR.

This chapter presents a brief discussion of the background and regulatory context of alternative disinfectants, including an overview of the disinfection profiling and benchmarking approach to evaluate disinfection efficiency. In addition, a decision-making framework is provided that utilities can employ to assess the applicability of various disinfectants and disinfection strategies for individual systems. Chapter 2 presents an overview of disinfection, including the use of chlorine, with the next six chapters of this manual devoted to each of the following alternative disinfectants and oxidants:

- **Chapter 3** - Ozone (O<sub>3</sub>);
- **Chapter 4** - Chlorine dioxide (ClO<sub>2</sub>);
- **Chapter 5** - Potassium permanganate (KMnO<sub>4</sub>);
- **Chapter 6** - Chloramine (NH<sub>2</sub>Cl);
- **Chapter 7** - Ozone/hydrogen peroxide combinations (O<sub>3</sub>/H<sub>2</sub>O<sub>2</sub>); and
- **Chapter 8** - Ultraviolet radiation (UV).

For each disinfectant, this guidance manual describes the chemistry specific to the disinfection or oxidation process, generation, primary uses and points of application, disinfection byproduct (DBP) formation, pathogen inactivation and disinfection efficacy, the status of analytical methods for residual monitoring, and operational considerations. Chapter 9 provides similar information regarding the use of combined disinfectants. A summary of existing disinfectant usage in the United States is provided in Appendix A. Cost estimates for the use of alternative disinfectants are provided in Appendix B.

## 1.2 Background

The most important use of disinfectants in water treatment is to limit waterborne disease and inactivate pathogenic organisms in water supplies. The first use of chlorine as a continuous process in water treatment was in a small town in Belgium in the early 1900s (White, 1992). Since introduction of filtration and disinfection at water treatment plants in the United States, waterborne diseases such as typhoid and cholera have been virtually eliminated. For example, in Niagara Falls, NY between 1911 and 1915, the number of typhoid cases dropped from 185 deaths per 100,000 population to nearly zero following introduction of filtration and chlorination (White, 1986).

In 1974, researchers in the Netherlands and the United States demonstrated that trihalomethanes (THMs) are formed as a result of drinking water chlorination (Rook, 1974; Bellar et al., 1974). THMs are formed when chlorine or bromide reacts with organic compounds in the water. EPA subsequently conducted surveys confirming widespread occurrence of THMs in chlorinated water supplies in the United States (Symons et al., 1975; USEPA, 1978). THMs and other DBPs have been shown to be carcinogenic, mutagenic, etc. These health risks may be small, but with the large population exposed, need to be taken seriously.

As a result of DBP concerns from chlorine, EPA, as well as the water treatment industry, placed more emphasis on the use of disinfectants other than chlorine. Some of these alternative disinfectants, however, have also been found to produce DBPs as a result of either reactions between disinfectants and compounds in the water or as a natural decay product of the disinfectant itself (McGuire et al., 1990; Legube et al.; 1989). These DBPs include:

- Halogenated organics, such as THMs, haloacetic acids, halo ketones, and others, that are produced primarily as a result of chlorination.

- Organic oxidation byproducts such as aldehydes, ketones, assimilable organic carbon (AOC), and biodegradable organic carbon (BDOC), that are associated primarily with strong oxidants such as ozone, chlorine, and advanced oxidation; and
- Inorganics such as chlorate and chlorite, associated with chlorine dioxide, and bromate, that is associated with ozone, and has also has been found when chlorine dioxide is exposed to sunlight.

As documented in this manual, the type and amount of DBPs produced during treatment depends largely on disinfectant type, water quality, treatment sequences, contact time, and environmental factors such as temperature and pH.

When considering the use of alternative disinfectants, systems should ensure that the inactivation of pathogenic organisms is not compromised. Pathogens pose an immediate critical public health threat due to the risk of an acute disease outbreak. Although most identified public health risks associated with DBPs are chronic, long-term risks, many systems will be able to lower DBP levels without compromising microbial protection.

### 1.3 Regulatory Context

Pursuant to requirements of the Safe Drinking Water Act (SDWA) Amendments of 1996, EPA is developing interrelated regulations to control microbial pathogens and disinfectant residuals and disinfection byproducts in drinking water. These rules are collectively known as the microbial/disinfection byproducts (M-DBP) rules and are intended to address complex risk trade-offs between the desire to inactivate pathogens found in water and the need to reduce chemical compounds formed as byproducts during disinfection. The rules are being promulgated in two phases.

As part of the first phase, the Stage 1 DBPR and the IESWTR were promulgated on December 16, 1998 (63 FR 69390 and 63 FR 69478, respectively). The Stage 1 DBPR applies to all community water systems (CWS) and non-transient, non-community water systems (NTNCWS) that treat their water with a disinfectant for either primary or residual treatment. The IESWTR amends the Surface Water Treatment Rule (SWTR) and includes new and more stringent requirements to control waterborne pathogens including specifically the protozoan *Cryptosporidium*. The IESWTR applies to all public water systems that use surface water, or ground water under the direct influence of surface water as defined at 40 CFR, Part 141, Subpart H<sup>1</sup>, and that serve at least 10,000 people.

Three future rules, also included in phase one include the Long-Term 1 Enhanced Surface Water Treatment Rule (LT1ESWTR), the Ground Water Rule (GWR), and the Filter Backwash Rule (FBR). Each of these rules are planned for promulgation in November 2000. The LT1ESWTR will address pathogen inactivation and removal requirements for Subpart H systems serving fewer than 10,000 people. The GWR will specify appropriate disinfection techniques, including the use of best

---

<sup>1</sup> Subpart H systems are defined as public water systems supplied by a surface water source or by a ground water source under the direct influence of surface water.

management practices (BMPs) and source control measures. The FBR will set a standard for filter backwash recycling for all public water systems regardless of size.

The second phase, consisting of the Stage 2 DBPR and the Long-Term 2 ESWTR, will be promulgated in the year 2002 and will revisit the regulations for the formation of DBPs for all systems and the inactivation and removal of pathogens for surface water systems, respectively.

The projected dates for future M-DBP regulatory activities are summarized in Table 1-1.

**Table 1-1. Key Dates for Regulatory Activities**

Date	Regulatory Action
November 2000	Promulgate Long-Term 1 Enhanced Surface Water Treatment Rule
November 2000	Promulgate Ground Water Rule
November 2000	Promulgate Filter Backwash Rule
May 2002	Promulgate Stage 2 Disinfectants and Disinfection Byproduct Rule
May 2002	Promulgate Long-Term 2 Enhanced Surface Water Treatment Rule

Concurrent with the M-DBP rules, in May 1996, EPA promulgated the Information Collection Rule (ICR) to obtain data on source water quality, byproduct formation, and drinking water treatment plant design and operations. The ICR applies to Subpart H systems serving more than 100,000 people and ground water systems serving more than 50,000 people. EPA intended to use data from the ICR to address completely the complex trade-offs between chronic DBP health risks and acute pathogenic health risks, but delays in promulgation of the ICR eliminated this potential data source for use in the IESWTR. Until the ICR data are analyzed in detail, EPA cannot fully address the issue of DBP and pathogenic risk trade-offs.

National Primary and Secondary Drinking Water Regulations, published in 40 CFR Parts 141 and 143, respectively, limit the amount of specific contaminants and residual disinfectants and classes of these compounds that are delivered to users of public water systems. These limits are expressed as follows:

- **Maximum Contaminant Level Goals (MCLGs).** MCLGs are non-enforceable health goals for public water systems. MCLGs are set at levels that, in the EPA Administrator's judgment, allow no known or anticipated adverse effect on the health of persons to occur and that allow an adequate margin of safety.
- **Maximum Residual Disinfectant Level Goals (MRDLGs).** As with MCLGs, EPA has established MRDLGs for disinfectants at levels at which no known or anticipated adverse effects on the health of persons occur and that allow an adequate margin of safety. MRDLGs are non-enforceable health goals based only on health effects and exposure information and do not reflect the benefit of the addition of the chemicals for control of waterborne microbial contaminants.

- **Maximum Contaminant Levels (MCLs).** MCLs are enforceable standards set as close to the MCLGs as technically and economically feasible.
- **Maximum Residual Disinfectant Levels (MRDLs).** MRDLs are similar to MCLs. MRDLs are enforceable standards, analogous to MCLs, that recognize the benefits of adding a disinfectant to water on a continuous basis and of addressing emergency situations such as distribution system pipe ruptures. As with MCLs, EPA has set the MRDLs as close to the MRDLGs as feasible.

In November 1979, the EPA set an interim MCL for Total THMs (TTHMs) of 0.10 mg/L as an annual average for systems serving at least 10,000 people. This standard was based on the need to reduce THM levels due to suspected carcinogenicity. Since then, EPA has developed and promulgated standards for numerous contaminants. As of the December 16, 1998 DBPR promulgation, MCLGs, MCLs, MRDLGs, and MRDLs are as presented in Tables 1-2 through 1-4. As included in these tables, the December 16, 1998 Stage 1 DBPR:

- Lowered the existing MCL for TTHMs from 0.10 mg/L to 0.080 mg/L;
- Extended the MCL for TTHMs to all size systems;
- Requires enhanced coagulation or enhanced precipitative softening for certain systems;
- Established MRDLs and MRDLGs for chlorine, chloramine, and chlorine dioxide;
- Established MCLs for haloacetic acid (five) (HAA5), bromate, and chlorite, and
- Established MCLGs for eight disinfection byproducts.

Further, the SWTR of 1989 requires 3.0-log inactivation for *Giardia* cysts and 4.0-log inactivation for viruses in surface water supplies. To meet these goals, the SWTR established treatment requirements for filtration and disinfection. As shown in Table 1-5, these goals can be met using various treatment schemes that include filtration and disinfection. The IESWTR requires a 2.0 log removal of *Cryptosporidium* for Subpart H systems serving at least 10,000 people.

**Table 1-2. Primary Drinking Water Regulations Related to Microbiological Contaminants**

Compound	MCLG (mg/L)	MCL (mg/L)	Potential Health Effects	Sources of Drinking Water Contamination
<i>Giardia lamblia</i>	Zero	TT <sup>1</sup>	Gastroenteric disease	Human and animal fecal waste
<i>Legionella</i>	Zero	TT	Legionnaire's disease	Common bacteria in natural waters; can proliferate in water heating systems
Heterotrophic Plate Count	N/A	TT	Indicates water quality, effectiveness of treatment	
Total Coliform	Zero	< 5.0% <sup>2</sup>	Indicates potential presence of gastroenteric pathogens	Human and animal fecal waste
Turbidity	N/A	TT	Indicates water treatment failure and pathogens in drinking water	Particles from storm runoff, discharges into source water, and erosion
Viruses	Zero	TT	Gastroenteric disease	Human and animal fecal waste

Source: AWWA Internet, 1997.

<sup>1</sup>TT = Treatment technique requirement in lieu of MCL as established in 40 CFR §141.70.

<sup>2</sup>No more than 5.0 percent positive if >40 samples/month. No more than 1 positive if <40 samples/month [40 CFR §141.63(a)].

**Table 1-3. Primary Drinking Water Regulations Related to Disinfection Byproducts**

Compound	MCLG (mg/L)	MCL (mg/L)	Potential Health Effects	Sources of Drinking Water Contamination
Bromate	Zero <sup>3</sup>	0.010 <sup>4</sup>	Cancer	Ozonation byproduct
Bromodichloromethane	Zero <sup>3</sup>	see TTHMs	Cancer, liver, kidney, and reproductive effects	Drinking water chlorination and chloramination byproduct
Bromoform	Zero <sup>3</sup>	see TTHMs	Cancer, nervous system, liver and kidney effects	Drinking water ozonation, chloramination, and chlorination byproduct
Chlorite	0.8 <sup>3</sup>	1.0 <sup>4</sup>	Hemolytic anemia	Chlorine dioxide disinfection byproduct
Chloroform	Zero <sup>3</sup>	see TTHMs	Cancer, liver, kidney, reproductive effects	Drinking water chlorination and chloramination byproduct
Dibromochloromethane	0.06 <sup>3</sup>	see TTHMs	Nervous system, liver, kidney, reproductive effects	Drinking water chlorination and chloramination byproduct
Dichloroacetic Acid	Zero <sup>3</sup>	See HAA5	Cancer and other effects	Drinking water chlorination and chloramination byproduct
Haloacetic Acids <sup>1</sup> (HAA5)	N/A	0.060 <sup>4</sup>	Cancer and other effects	Drinking water chlorination and chloramination byproduct
Trichloroacetic Acid	0.3 <sup>3</sup>	See HAA5	Possibly cancer and reproductive effects	Drinking water chlorination and chloramination byproduct
Total Trihalomethanes <sup>2</sup> (TTHMs)	N/A	0.08 <sup>4</sup>	Cancer and other effects	Drinking water chlorination and chloramination byproduct

Source: 63 FR 69390 (12/16/98)

<sup>1</sup> HAA5 is the sum of the concentrations of mono-, di-, and trichloroacetic acids and mono- and dibromoacetic acids.

<sup>2</sup> Total Trihalomethanes are the sum of the concentrations of bromodichloromethane, dibromochloromethane, bromoform, and chloroform.

<sup>3</sup> Finalized on December 16, 1998 (63 FR 69390) as established in 40 CFR §141.53.

<sup>4</sup> Finalized on December 16, 1998 (63 FR 69390) as established in 40 CFR §141.64

**Table 1-4. Primary Drinking Water Regulations Related to Residual Disinfectants**

Disinfectant	MRDLG <sup>3</sup> (mg/L)	MRDL <sup>4</sup> (mg/L)
Chlorine <sup>1</sup>	4 (as Cl <sub>2</sub> )	4.0 (as Cl <sub>2</sub> )
Chloramine <sup>2</sup>	4 (as Cl <sub>2</sub> )	4.0 (as Cl <sub>2</sub> )
Chlorine Dioxide	0.8 (as ClO <sub>2</sub> )	0.8 (as ClO <sub>2</sub> )

<sup>1</sup> Measured as free chlorine

<sup>2</sup> Measured as total chlorine

<sup>3</sup> Finalized on December 16, 1998 (63 *FR* 69390) as established in 40 CFR §141.54.

<sup>4</sup> Finalized on December 16, 1998 (63 *FR* 69390) as established in 40 CFR §141.65

**Table 1-5. Log Removal/Inactivation through Filtration and Disinfection Required Under the SWTR**

Process	<i>Giardia</i> cysts	Virus
<b>Total log removal/inactivation Required</b>	<b>3.0</b>	<b>4.0</b>
Conventional sedimentation/filtration credit	2.5	2.0
Disinfection inactivation required	0.5	2.0
Direct filtration credit	2.0	1.0
Disinfection inactivation required	1.0	3.0
Slow sand filtration credit	2.0	2.0
Disinfection inactivation required	1.0	2.0
Diatomaceous earth credit	2.0	1.0
Disinfection inactivation required	1.0	3.0
No Filtration	0.0	0.0
Disinfection inactivation required	3.0	4.0

Source: AWWA, 1991.

Note: Some instances may require higher than 3 and 4 log removal. Also, some states may reduce removal filtration process.

### 1.3.1 Disinfection Profiling and Benchmarking

The IESWTR establishes disinfection benchmarking as a procedure requiring certain PWSs to evaluate the impact on microbial risk of proposed changes in disinfection practice. It is designed to facilitate utilities and States working together to assure that pathogen control is maintained while the provisions of the Stage 1 DBPR are implemented. This procedure involves a PWS charting daily levels of pathogen inactivation for a period of at least one year to create a profile of inactivation performance. The PWS then uses this profile to determine a baseline or benchmark of inactivation against which proposed changes in disinfection practices can be measured.

Systems are required to prepare a disinfection profile if either TTHM or HAA5 levels are at least 0.064 or 0.048 mg/L, respectively, as an annual average. These levels, equal to 80 percent of the MCLs established for these compounds by the Stage 1 DBPR, are intended to include most systems that will modify their disinfection practices to comply with the Stage 1 DBPR. To determine applicability, systems that collected TTHM and HAA5 data under the ICR must use the results of the

last 12 months of ICR monitoring unless the State determines there is a more representative data set. Non-ICR systems may use existing TTHM and HAA5 data, if approved by the State, or must conduct TTHM and HAA5 monitoring for four quarters. This monitoring must be completed no later than 15 months after promulgation of the IESWTR (i.e., by March, 2000). Alternatively, systems can elect to forgo this monitoring if they construct a disinfection profile.

A **disinfection** profile consists of a compilation of daily *Giardia lamblia* log inactivations (plus virus inactivations for systems using either **chloramines or ozone** for primary disinfection) computed over a period of at least one year. It is based on daily measurements of disinfectant residual concentration(s), contact time(s), temperature, and pH. The profile may be developed using up to 3 years of existing (i.e. grandfathered) data, if the State finds the data acceptable. Systems having less than 3 years of acceptable grandfathered data are required to conduct one year of monitoring to create the profile. This monitoring must be complete within 27 months of IESWTR promulgation (i.e., by March, 2001). The disinfection benchmark is equal to the lowest monthly average inactivation level in the disinfection profile (or average of low months for multi-year profiles).

Any system required to develop a disinfection profile under the IESWTR that decides to make a significant change to its disinfection practice must consult with the State prior to making the change. Significant changes in disinfection practice are defined as: 1) moving the point of disinfection, not including routine seasonal changes, 2) changing the type of disinfectant, 3) changing the disinfection process, and 4) other modifications designated as significant by the State. As part of the consultation process, the system must submit to the State the following information: a description of the proposed change; the disinfection profile for *Giardia lamblia* (and, if necessary, viruses) and benchmark; and an analysis of how the proposed change will affect the current levels of disinfection. In addition, the State is required to review the disinfection profile a part of its periodic sanitary survey.

For more information on disinfection profiling and benchmarking, refer to EPA's *Disinfection Profiling and Benchmarking Guidance Manual* (expected to be available in 1999).

## 1.4 Use of Disinfectants as Chemical Oxidants

Most disinfectants are strong oxidants and/or generate oxidants as byproducts (such as hydroxyl free radicals) that react with organic and inorganic compounds in water. While the primary focus of this manual is disinfection, many of the disinfectants described in this manual are also used for other purposes in drinking water treatment, such as taste and odor control, improved flocculation, and nuisance control. Because DBPs are produced irrespective of the intended purpose of the oxidant, it is important to also address uses of disinfectants as oxidants in water treatment. These additional uses are described in more detail in Chapter 2.

## 1.5 How Chlorine is Addressed in this Guidance Manual

This guidance manual does not provide as broad a discussion of chlorine and chlorination practices as it does for the capabilities and uses of alternative disinfectants. There are two reasons EPA has

taken this approach: 1) the goal of this manual is to provide technical and engineering information to utilities and the states on alternative disinfectants and oxidants, about which there is less comprehensive information than for chlorine; and 2) a great majority of utilities already use chlorine, in a wide variety of applications, for which there exists a wealth of literature on chlorine's uses and performance capabilities. Summarizing this large body of knowledge in this guidance is neither practical nor necessary.

This manual is not an EPA endorsement of alternative disinfectants nor is it a recommendation for utilities to switch from chlorine to an alternative disinfectant. Rather, this manual provides technical and engineering information to assist local professionals in making treatment decisions. EPA believes that utility and state program personnel are best able to select disinfectants and design a disinfection scheme, based upon site-specific conditions, that meets operational and regulatory constraints. EPA does not require the use of chlorine or any other specific disinfectant for site-specific uses. Again, local professionals are best suited to select disinfectants to address the unique water treatment challenges posed by their source water and plant infrastructure.

EPA recognizes that, at the present time, chlorination is an important and central component of most water treatment regimes in this country. As such, a summary of the uses and capabilities of chlorine is provided in Section 2.7 of this manual. Section 2.7 also contains an extensive reference list for additional information on chlorination.

## 1.6 A Summary of Alternative Disinfectant Properties

Subsequent chapters in this manual discuss several disinfectant alternatives available to a water supplier. Table 1-6 summarizes the key technical and regulatory considerations associated with the use of the various disinfectants for selecting the most appropriate disinfectant. The table provides some broad guidelines to provide a framework for decision making. The ratings in Table 1-6 are based on a typical disinfectant application. Thus, even though chlorine is considered to be prone to THM formation, the table does not address the degree or amount of THMs produced. Similarly, more than 2-log inactivation can be achieved for some disinfectants, but the high dose required may not make it a reasonable application, and in that case, would be identified in the table as not able to achieve 2-log inactivation.

The following key issues are addressed in Table 1-6:

- **THMs, oxidized organics, and halogenated organics are produced.** Halogenated organics are formed when chlorine or ozone (in the presence bromide ion) is used, while oxidized organics occur in the greatest concentration when a strong oxidant is used. The production of DBPs depends on the amounts and types of precursors in the water.
- **Inorganic byproducts are produced.** Inorganic byproducts include chlorate ion, chlorite ion, and bromate ion associated with chlorine dioxide and ozone.

- **MRDLs are required for some disinfectants.** Note that this requirement must be balanced with the requirement to maintain a residual in the distribution system. For most disinfectants, such as chlorine, the MRDL is relatively high and will generally not create a problem.
- **Lime softening impacts are noted.** The high pH treatment during lime softening has an impact on chlorine, chloramines, and UV.
- **Turbidity impacts UV disinfection and ozonation.** Ozone may interfere with coagulation and settling. As such, it is recommended that ozonation be placed after settling but before filters to minimize turbidity impacts.
- **Inactivation requirements are divided into those achieving more or less than 2-log inactivation.** This differentiation is to identify the feasibility of achieving high inactivation at modest doses. For example, while chlorine can achieve 3-log *Giardia* cyst inactivation, the CT requirement for 3-log inactivation of 100 to more than 300 mg-min/L will require high chlorine doses and/or long contact times. However, 4-log virus inactivation is achievable with a CT of 15 to 60 mg-min/L for most temperatures.

Recently there has been some reports of 2-log and higher *Cryptosporidium* oocyst inactivation with UV, using a system that concentrates the oocysts on a filter and then allows extended exposure to UV to doses as high as 8,000 mW·s/cm<sup>2</sup>. This type application is considered experimental at this time.

- **Applicability as a secondary disinfectant represents the ability of the disinfectant to maintain a residual in the distribution system.** Only chlorine, chlorine dioxide, and monochloramine provide residual disinfection in the distribution system. Chlorine dioxide is limited to systems with smaller distribution systems because the total chlorine dioxide dose that can be applied is limited by the production of chlorate ion and chlorite ion.
- **Operator skill provides general guidance to the amount of operator attention and maintenance required.** All of the disinfectants can be placed on automatic control to limit the amount of operator attention. The operational attention is rated based on the complexity of the disinfectant application. Therefore, permanganate, which is a simple chemical feed system with few mechanical elements, is rated 1 (low attention), while peroxone which include both ozone systems and hydrogen peroxide feed systems, is rated 5 (high attention).
- **All chemical disinfectants are judged to be applicable to small and large utilities.** Modular units of the technologies can cover a large range of flows. Ozone and chlorine dioxide generators are available with small and large capacities. Chlorine and chemical feed systems have been used successfully in all applications. Most UV water treatment facilities are less than 200 gpm in capacity.

Key elements in the decision making process relate to the water source (i.e., ground or surface water) and existing treatment configuration (including filtration) because these factors have a significant impact on the degree of log removal required during disinfection. Water quality has a large impact on the potential for DBP BOM formation.

**Table 1-6. Summary of Disinfectant Properties  
(Based on Typical Disinfectant Application)**

Condition	Chlorine	Ozone	Chlorine Dioxide	Permanganate	Chloramine	Ozone/Peroxide	Ultraviolet
Produce THM with TOC	y	s	n	n	y	s	n
Produce oxidized organics	s	y	s	s	n	y	s
Produce halogenated organics	y	s	n	n	y	s	n
Produce inorganic byproducts	n	s	y	n	n	s	n
Produce BOM	s	y	s	n	n	y	n
MRDL applies	y	n	y	n	y	n	n
Lime softening impacts	y	n	n	n	y	n	y
Turbidity impacts	n	s	n	n	n	s	y
Meet <i>Giardia</i> - <2.0 log	y	y	y	n	n	n	n
Meet <i>Giardia</i> - >2.0 log	n	y	y	n	n	n	n
Meet <i>Crypto</i> - <2.0 log	n	y	y	n	n	n	n
Meet <i>Crypto</i> - >2.0 log	n	y	n	n	n	n	n
Meet Virus - <2.0 log	y	y	y	n	n	n	y
Meet Virus - >2.0 log	y	y	y	n	n	n	y
Secondary disinfectant	y	n	s	n	y	n	n
Operator skill (1=low; 5=high)	1	5	5	1	2	5	3
Applicable to large utilities	y	y	y	y	y	y	n
Applicable to small utilities	y	y	y	y	y	y	y

y = yes, n = no, s = sometimes

The following sections describe each of these phases.

## 1.7 Selecting a Disinfection Strategy

This section presents general guidance that can be used to assess the applicability of various disinfectants or combination of disinfectants to select an appropriate disinfection strategy. Because the selection of an appropriate strategy depends on site-specific conditions unique to each water supply system, final selection of a strategy should be made with appropriate technical guidance (e.g., engineering study/evaluation or bench or pilot scale testing of alternatives). Selecting the most appropriate disinfectant strategy for water treatment requires a balance among three key driving forces:

- Providing water free of pathogens.** Since the SWTR, the regulatory focus for pathogen removal focused on coliform bacteria, heterotrophic plate counts, *Giardia* cysts, *Legionella*, and viruses. Recently, the focus has been expanded to include *Cryptosporidium* oocyst removal and inactivation, especially due to its resistance to chlorine.

- **Avoiding the production of disinfection byproducts (DBPs).** Trihalomethanes (THMs), other halogenated organics, ozone DBPs, oxidation byproducts, and some disinfectant residuals present a health risk and must be limited in drinking waters. DBP precursor removal through process optimization or enhanced coagulation is the first step in DBP control.
- **Requiring residual disinfectant to maintain the bacteriological quality in the water as it is distributed to customers to control regrowth.** The potential for DBP formation increases with extended contact between DBP precursors and residual disinfectants.

When changing disinfectants or oxidants water providers should consult with their primacy agencies. The impact of the change should consider the impact on disinfection credit using disinfection profiling and benchmarking techniques as summarized in Section 1.3.

### 1.7.1 Disinfection Strategy Evaluation

The selection of a disinfection strategy, as presented below, is affected by the following:

- Effectiveness of the current disinfection system;
- Need to change disinfectants;
- Selection of an alternative disinfectant; and
- Primary and secondary disinfection requirements.

As used in this guidance, primary and secondary disinfection are defined as follows:

**Primary disinfection:** The first (i.e., primary) disinfectant used in a treatment system, with the primary objective of the disinfectant being to achieve the necessary CT (i.e., microbial inactivation).

**Secondary disinfection:** The second disinfectant used in a treatment system, with the primary objective of the disinfectant being to maintain the disinfection residual through the distribution system.

For discussion, the approach to select a disinfection strategy is divided into three phases:

- Evaluate the current primary disinfection practice
- Select a primary disinfectant
- Select a secondary disinfectant.

#### 1.7.1.1 Evaluate the Current Primary Disinfection Practice

Figure 1-1 presents the decision making process used to determine whether the present primary disinfectant can meet disinfection and byproduct requirements. The key decision points in Figure 1-1 include:

- **Meet current microbial inactivation limits.** Microbial limits are defined by the primary drinking water standards shown in Table 1-2. The regulated indicators of pathogens include

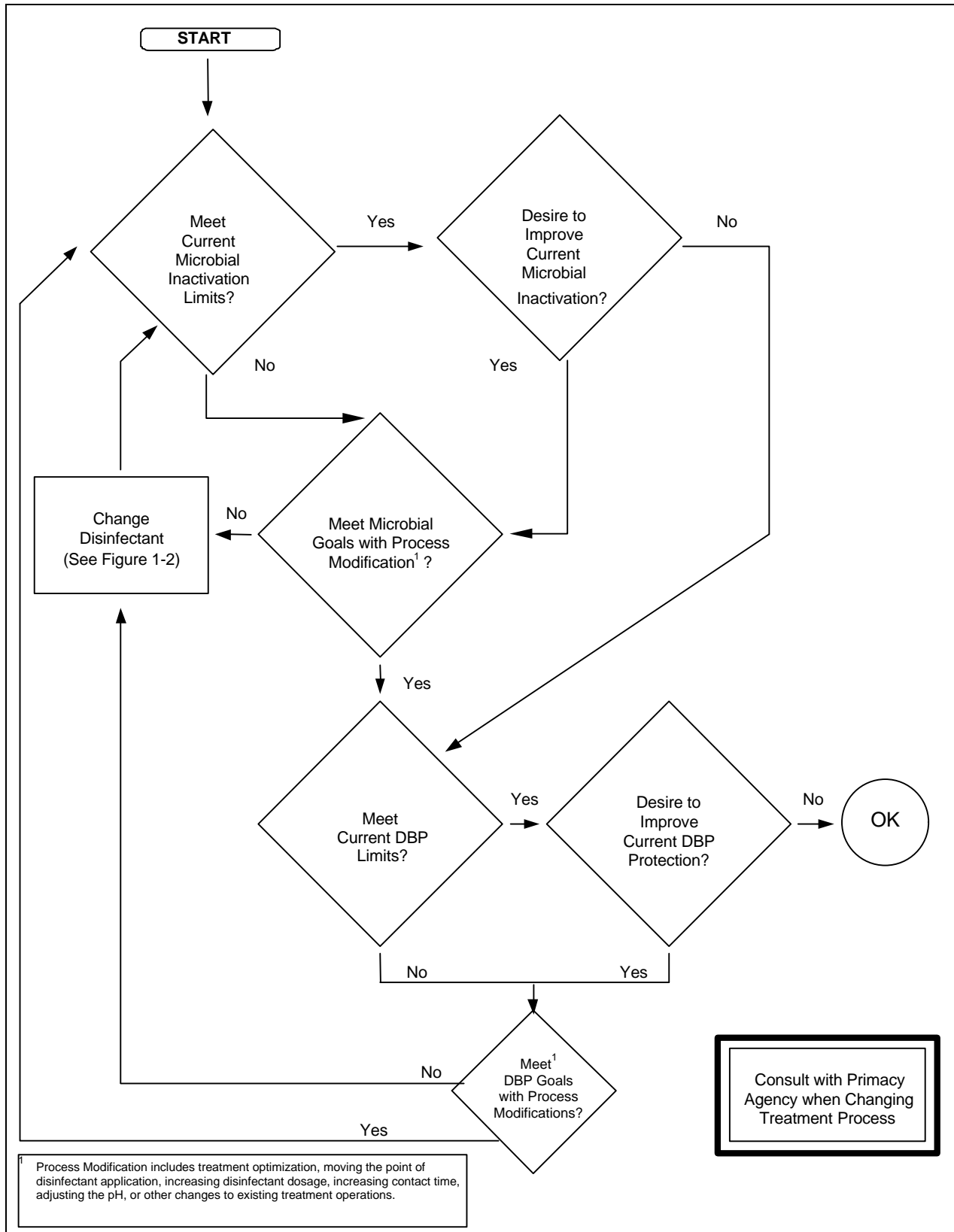
*Giardia lamblia*, *Legionella*, HPC, total coliform turbidity, and viruses. The disinfectant must be capable of meeting the inactivation requirements for disinfection. If not, the plant must determine if the current disinfectant can meet the microbial inactivation requirements solely through process modifications. A process modification may be to move the application point, increase dose, increase contact time, or adjust pH. If not, a new disinfectant may be needed. In some instances, a PWS may opt to improve its current microbial inactivation even though the PWS is meeting current microbial limitations. In these instances, an evaluation is necessary to ensure that any process modifications to improve inactivation will still provide compliance with the microbial limits.

- **Meet current DBP limits.** A second set of limits imposed on disinfectant usage are DBP requirements. The DBP limits are established in the Stage 1 DBP rule (See Table 1-3 and Table 1-5). To meet these limits on a consistent basis under normal varying water quality conditions, 80 percent of the MCL serves as an action level that requires a change in treatment practice. Similar to microbial inactivation, some PWSs may desire to improve current DBP protection, thus requiring evaluation of these modifications. By optimizing existing treatment processes, the production of DBPs can be reduced. Optimization may include pretreatment optimization (i.e., coagulation, filtration, etc.) or process modifications such as moving the point of disinfection. Enhanced coagulation is required by the Stage 1 DBP rule. Where process modifications are contemplated, the PWS must ensure that both microbial inactivation and DBP formation comply with applicable regulatory requirements. If optimized treatment cannot meet DBP and microbial requirements, a new disinfectant may be needed.

#### 1.7.1.2 Select a Primary Disinfectant

If it is determined that a new disinfectant is required or desired for better public health protection, the second phase in the decision process (Figure 1-2) addresses the factors concerning selection of a primary disinfectant. This decision requires knowledge of the following three key components:

- **TOC concentration.** A high TOC concentration indicates a high potential for DBP formation. In these cases, the decision tree will favor those disinfectants that will not produce DBPs or will produce the least amount of DBPs. Note that precursor removal and enhanced coagulation are used to reduce TOC during treatment optimization as indicated in Figure 1-1. “High TOC” quantifies the potential to produce DBPs and is defined as a condition meeting one of the following criteria:
  - TOC exceeds 2 mg/L;
  - TTHM exceeds MCL (0.08 mg/L under Stage 1 DBPR); or
  - HAA5 exceeds MCL (0.06 mg/L under Stage 1 DBPR).



**Figure 1-1. Flow Diagram to Evaluate Current Disinfection Practices**

- **Bromide ion concentration.** The reactions of strong oxidants (ozone and peroxone) with bromide ion to produce hypobromous acid and bromate ion, precludes their usage with waters containing high concentrations of bromide ion. High bromide ion is defined as concentrations exceeding 0.10 mg/L.
- **Filtered versus non-filtered systems.** The use of ozone or ozone/peroxide for unfiltered systems without the benefit of biofiltration to reduce ozonation byproducts and BOM is strongly discouraged.

### 1.7.1.3 Select a Secondary Disinfectant

The selection of a secondary disinfectant depends on the selected primary disinfectant. Figure 1-3 identifies three decision points for secondary disinfectants:

- **Assimilable organic carbon (AOC) concentration.** AOC is produced when a strong oxidant (e.g., ozone) is used as primary disinfectant in the presence of high TOC water. High AOC is defined as concentrations exceeding 0.10 mg/L after filtration. In these cases, additional biological or GAC treatment should be considered to stabilize the finished water and prevent regrowth in the distribution system.
- **DBP formation potential (DBPFP).** The DBPFP serves as an indication of the amount of organic byproducts that could be expected to form in the distribution system if chlorine is used. Because DBP formation continues in the distribution system, the DBP content at the plant effluent should be limited. A high DBPFP is defined as a water meeting one of the following criteria:
  - TTHM seven-day formation exceeds the MCL (0.08 mg/L under Stage 1 DBPR); or
  - HAA5 seven-day formation exceeds the MCL (0.06 mg/L under the Stage 1 DBPR).
- **Distribution system retention time.** In a large distribution system, booster stations may be required to maintain the disinfection residual. Since chlorine dioxide has an upper limit for application, its usage may not be feasible if relatively high doses are required to maintain a residual in the distribution system. A distribution system retention time is considered high if it exceeds 48 hours.

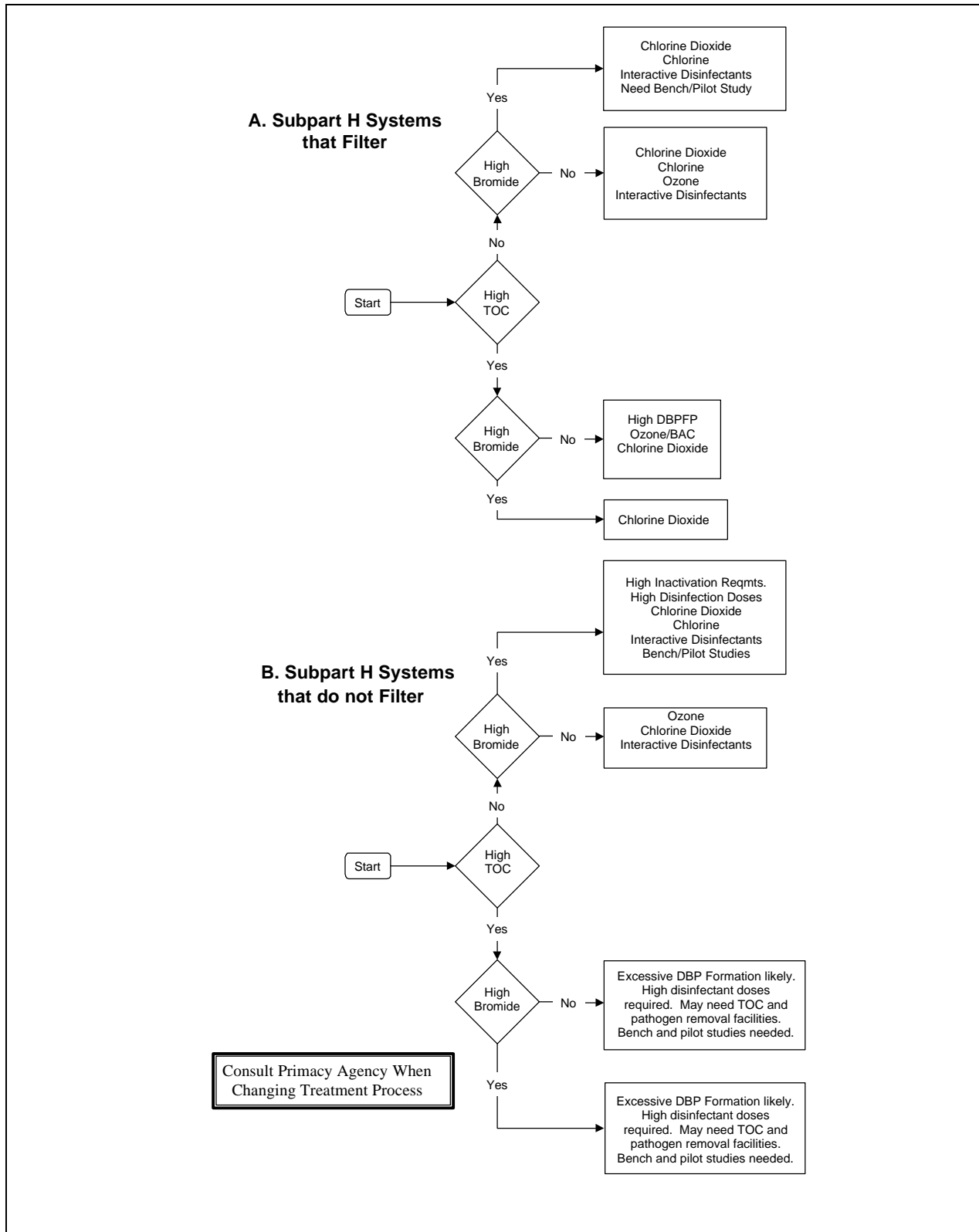
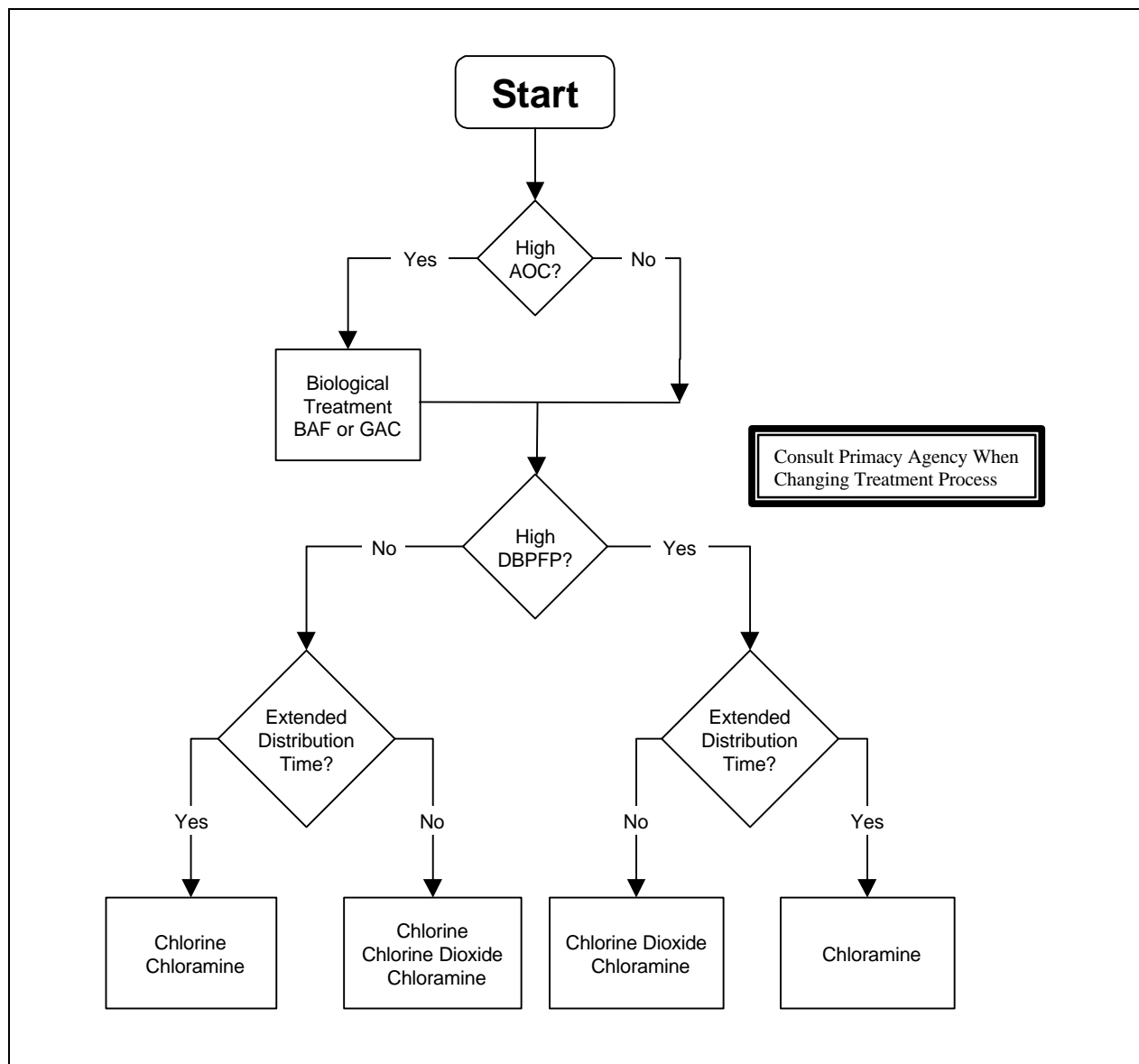


Figure 1-2. Flow Diagram to Narrow Selection of a New Primary Disinfectant



**Figure 1-3. Flow Diagram to Narrow Selection of a New Secondary Disinfectant**

## 1.7.2 Summary

The approach outlined above serves as a basis to evaluate the need for and to select the most appropriate alternative disinfectants for drinking water systems. The approach is general enough to cover the likely outcomes of the inactivation requirements and DBP formation. However, in some cases, site-specific conditions may dictate a different approach. It is important to consult with the primacy agency whenever a change in treatment is considered. Remember that the IESWTR requires certain PWSs to use disinfection profiling and benchmarking procedures when proposing changes to disinfection practices. In addition, some of the decisions may lead to a situation where additional treatment will be required. For example, filtration may be needed to reduce the disinfectant dose and

limit DBP formation in cases of high TOC and high bromide ion levels. In those instances, bench scale or pilot studies may be required to select the most appropriate disinfectant.

## 1.8 References

1. AWWA (American Water Works Association). 1991. *Guidance Manual for Compliance with the Filtration and Disinfection Requirements for Public Works Systems Using Surface Water Sources*.
2. AWWA Safe Drinking Water Advisor - Library on Internet (1997).
3. Bellar, T.A, J.J. Lichtenberg, and R.C. Kroner. 1974. "The Occurrence of Organohalides in Chlorinated Drinking Water." *J. AWWA*. 66(12): 703-706.
4. Legube, B., J.P. Croue', J. De Latt, and M. Dore'. 1989. "Ozonation of an Extracted Aquatic Fulvic Acid: Theoretical and Practical Aspects." *Ozone Sci. Eng.* 11(1): 69-91.
5. McGuire, M.J., D.W. Ferguson, and J.T. Gramith. 1990. Overview of Ozone Technology for Organics Control and Disinfection. Conference proceedings, AWWA Seminar on Practical Experiences with Ozone for Organics Control and Disinfection, Cincinnati, OH.
6. Rook, J.J. 1974. "Formation of Haloforms during Chlorination of Natural Water." *Water Treatment and Examination*. 23(2): 234-243.
7. Sawyer, C.N., P.L. McCarty, L. Parkin, and G.F. Parkin. 1994. *Chemistry for Environmental Engineering*, fourth edition. McGraw Hill, Inc., New York, NY.
8. Symons, J.M., T.A. Bellar, J.K. Carswell, J. DeMarco, K.L. Kropp, G.G. Robeck, D.R. Seeger, C.J. Slocum, B.L. Smith and A.A. Stevens. 1975. "National Organics Reconnaissance Survey for Halogenated Organics." *J. AWWA*. 67(11): 634-647.
9. USEPA (U.S. Environmental Protection Agency). 1997. *Community Water System Survey - Volume II*. Detailed Survey Result Tables and Methodology Report. EPA 815-R-97-001b.
10. USEPA. 1978. National Organics Monitoring Survey (NOMS). Technical Support Division, U.S. Environmental Protection Agency, Office of Drinking Water. Cincinnati, OH.
11. White, G.C. 1992. *Handbook of Chlorination and Alternative Disinfectants*. Vol. 3. Van Nostrand Reinhold Co. New York, NY.
12. White, G.C. 1986. *Handbook of Chlorination*. Van Nostrand Reinhold Company, New York, NY.

Introduction .....	1-1
1.1 Objective of this Manual .....	1-1
1.2 Background .....	1-2
1.3 Regulatory Context .....	1-3
1.3.1 Disinfection Profiling and Benchmarking .....	1-7
1.4 Use of Disinfectants as Chemical Oxidants.....	1-8
1.5 How Chlorine is Addressed in this Guidance Manual.....	1-8
1.6 A Summary of Alternative Disinfectant Properties.....	1-9
1.7 Selecting a Disinfection Strategy .....	1-11
1.7.1 Disinfection Strategy Evaluation.....	1-12
1.7.1.1 Evaluate the Current Primary Disinfection Practice .....	1-12
1.7.1.2 Select a Primary Disinfectant .....	1-13
1.7.1.3 Select a Secondary Disinfectant .....	1-15
1.7.2 Summary.....	1-17
1.8 References .....	1-18
Table 1-1. Key Dates for Regulatory Activities .....	1-4
Table 1-2. Primary Drinking Water Regulations Related to Microbiological Contaminants.....	1-6
Table 1-3. Primary Drinking Water Regulations Related to Disinfection Byproducts .....	1-6
Table 1-4. Primary Drinking Water Regulations Related to Residual Disinfectants .....	1-7
Table 1-5. Log Removal/Inactivation through Filtration and Disinfection Required Under the SWTR.....	1-7
Table 1-6. Summary of Disinfectant Properties .....	1-11
(Based on Typical Disinfectant Application).....	1-11
Figure 1-1. Flow Diagram to Evaluate Current Disinfection Practices.....	1-14
Figure 1-2. Flow Diagram to Narrow Selection of a New Primary Disinfectant .....	1-16
Figure 1-3. Flow Diagram to Narrow Selection of a New Secondary Disinfectant.....	1-17

## 2. DISINFECTANT USE IN WATER TREATMENT

---

To comply with the SDWA regulations, the majority of PWSs use some form of water treatment. The 1995 Community Water Systems Survey (USEPA, 1997a) reports that in the United States, 99 percent of surface water systems provide some treatment to their water, with 99 percent of these treatment systems using disinfection/oxidation as part of the treatment process. Although 45 percent of ground water systems provide no treatment, 92 percent of those ground water plants that do provide some form of treatment include disinfection/oxidation as part of the treatment process. The most commonly used disinfectants/oxidants (in no particular order) are chlorine, chlorine dioxide, chloramines, ozone, and potassium permanganate.

Disinfectants are also used to achieve other specific objectives in drinking water treatment. These other objectives include nuisance control (e.g., for zebra mussels and Asiatic clams), oxidation of specific compounds (i.e., taste and odor causing compounds, iron, and manganese), and use as a coagulant and filtration aid.

The purpose of this chapter is to:

- Provide a brief overview of the need for disinfection in water treatment.
- Provide basic information that is common to all disinfectants;
- Discuss other uses for disinfectant chemicals (i.e., as oxidants);
- Describe trends in DBP formation and the health effects of DBPs found in water treatment;
- Discuss microorganisms of concern in water systems, their associated health impact, and the inactivation mechanisms and efficiencies of various disinfectants; and
- Summarize current disinfection practices in the United States, including the use of chlorine as a disinfectant and an oxidant.

### 2.1 Need for Disinfection in Water Treatment

Although the epidemiological relation between water and disease had been suggested as early as the 1850s, it was not until the establishment of the germ theory of disease by Pasteur in the mid-1880s that water as a carrier of disease-producing organisms was understood. In the 1880s, while London experienced the “Broad Street Well” cholera epidemic, Dr. John Snow conducted his now famous epidemiological study. Dr. Snow concluded that the well had become contaminated by a visitor, with the disease, who had arrived in the vicinity. Cholera was one of the first diseases to be

recognized as capable of being waterborne. Also, this incident was probably the first reported disease epidemic attributed to direct recycling of non-disinfected water. Now, over 100 years later, the list of potential waterborne diseases due to pathogens is considerably larger, and includes bacterial, viral, and parasitic microorganisms, as shown in Table 2-1, Table 2-2 and Table 2-3, respectively.

A major cause for the number of disease outbreaks in potable water is contamination of the distribution system from cross connections and back siphonage with non-potable water. However, outbreaks resulting from distribution system contamination are usually quickly contained and result in relatively few illnesses compared to contamination of the source water or a breakdown in the treatment system, which typically produce many cases of illnesses per incident. When considering the number of cases, the major causes of disease outbreaks are source water contamination and treatment deficiencies (White, 1992). For example, in 1993 a Cryptosporidiosis outbreak affected over 400,000 people in Milwaukee, Wisconsin. The outbreak was associated with deterioration in the raw water quality and a simultaneous decrease in the effectiveness of the coagulation-filtration process (Kramer et al., 1996; MacKenzie et al., 1994). Historically, about 46 percent of the outbreaks in the public water systems are found to be related to deficiencies in source water and treatment systems with 92 percent of the causes of illness due to these two particular problems.

All natural waters support biological communities. Because some microorganisms can be responsible for public health problems, biological characteristics of the source water are one of the most important parameters in water treatment. In addition to public health problems, microbiology can also affect the physical and chemical water quality and treatment plant operation.

## 2.1.1 Pathogens of Primary Concern

Table 2-4 shows the attributes of three groups of pathogens of concern in water treatment, namely bacteria, viruses, and protozoa.

### 2.1.1.1 *Bacteria*

Bacteria are single-celled organisms typically ranging in size from 0.1 to 10  $\mu\text{m}$ . Shape, components, size, and the manner in which they grow can characterize the physical structure of the bacterial cell. Most bacteria can be grouped by shape into four general categories: spheroid, rod, curved rod or spiral, and filamentous. Cocci, or spherical bacteria, are approximately 1 to 3  $\mu\text{m}$  in diameter. Bacilli (rod-shaped bacteria) are variable in size and range from 0.3 to 1.5  $\mu\text{m}$  in width (or diameter) and from 1.0 to 10.0  $\mu\text{m}$  in length. Vibrios, or curved rod-shaped bacteria, typically vary in size from 0.6 to 1.0  $\mu\text{m}$  in width (or diameter) and from 2 to 6  $\mu\text{m}$  in length. Spirilla (spiral bacteria) can be found in lengths up to 50  $\mu\text{m}$  whereas filamentous bacteria can occur in length in excess of 100  $\mu\text{m}$ .

**Table 2-1. Waterborne Diseases from Bacteria**

Causative Agent	Disease	Symptoms	Reservoir
<i>Salmonella typhosa</i>	Typhoid Fever	Headache, nausea, loss of appetite, constipation or diarrhea, insomnia, sore throat, bronchitis, abdominal pain, nose bleeding, shivering and increasing fever. Rose spots on trunk. Incubation period: 7-14 days.	Feces and urine of typhoid carrier or patient.
<i>S. paratyphi</i> <i>S. schottinulleri</i> <i>S. hirschfeldi</i> C.	Paratyphoid fever	General infection characterized by continued fever, diarrhea disturbances, sometimes rose spots on trunk. Incubation period: 1-10 days.	Feces and urine of carrier or patient.
<i>Shigella flexneri</i> <i>Sh. dysenteriae</i> <i>Sh. sonnei</i> <i>Sh. paradysinteriae</i>	Bacillary dysentery	Acute onset with diarrhea, fever, tenesmus and stool frequently containing mucus and blood. Incubation period: 1-7 days.	Bowel discharges of carriers and infected persons.
<i>Vibrio comma</i> <i>V. cholerae</i>	Cholera	Diarrhea, vomiting, rice water stools, thirst, pain, coma. Incubation period: a few hours to 5 days.	Bowel discharges, vomitus, carriers.
<i>Pasteurella tularensis</i>	Tularemia	Sudden onset with pains and fever; prostration. Incubation period: 1-10 days.	Rodent, rabbit, horsefly, woodtick, dog, fox, hog.
<i>Brucella melitensis</i>	Brucellosis (undulant fever)	Irregular fever, sweating, chills, pain in muscles.	Tissues, blood, mold, urine, infected animal.
<i>Pseudomonas pseudomallei</i>	Melioidosis	Acute diarrhea, vomiting, high fever, delirium, mania.	Rats, guinea pigs, cats, rabbits, dogs, horses.
<i>Leptospira icterohaemorrhagiae</i> ( <i>spirochaetales</i> )	Leptospirosis (Well's disease)	Fevers, rigors, headaches, nausea, muscular pains, vomiting, thirst, prostration and jaundice may occur.	Urine and feces of rats, swine, dogs, cats, mice, foxes, sheep.
Enteropathogenic <i>E. coli</i>	Gastroenteritis	Water diarrhea, nausea, prostration and dehydration.	Feces of carrier.

Sources: Salvato, 1972; Geldreich, 1972.

**Table 2-2. Waterborne Diseases from Human Enteric Viruses**

Group	Subgroup	No. of Types or Subtypes	Disease Entities Associated with These Viruses	Pathological Changes in Patients	Organs Where Virus Multiplies
Enterovirus	Poliovirus	3	Muscular paralysis Aseptic meningitis Febrile episode	Destruction of motor neurons Inflammation of meninges from virus Viremia and viral multiplication	Intestinal mucosa, spinal cord, brain stem Meninges Intestinal mucosa and lymph
	Echovirus	34	Aseptic meningitis Muscular paralysis Guillain-Barre's Syndrome <sup>1</sup> Exanthem Respiratory diseases  Diarrhea Epidemic myalgia Pericarditis and myocarditis  Hepatitis	Inflammation of meninges from virus Destruction of motor neurons Destruction of motor neurons Dilation and rupture of blood vessels Viral invasion of parenchymatous of respiratory tracts and secondary inflammatory responses intestinal infections Not well known Viral invasion of cells with secondary inflammatory responses Invasion of parenchyma cells	Stem Intestinal mucosa, spinal cord, brain Spinal cord Skin Respiratory tracts and lungs Gastrointestinal tract Respiratory tract and gastrointestinal tract Pericardial and myocardial tissue  Liver
	Coxsackie-virus	>24	Herpangina <sup>2</sup>	Viral invasion of mucosa with secondary inflammation	Mouth
	A		Acute lymphatic pharyngitis Aseptic meningitis Muscular paralysis Hand-foot-mouth disease <sup>3</sup> Respiratory disease  Infantile diarrhea Hepatitis Pericarditis and myocarditis	Sore throat, pharyngeal lesions Inflammation of meninges from virus Destruction of motor neurons Viral invasion of skin cells of hands-feet-mouth Viral invasion of parenchymatous of respiratory tracts and secondary inflammatory responses Viral invasion of cells of mucosa Invasion of parenchyma cells Viral invasion of cells with secondary inflammatory responses	Lymph nodes and pharynx Meninges Intestinal mucosa, spinal cord, brain stem Skin of hands-feet, and much of mouth Respiratory tracts and lungs  Intestinal mucosa Liver Pericardial and myocardial tissue

<sup>1</sup> Ascending type of muscular paralysis<sup>2</sup> Febrile episode with sores in mouth<sup>3</sup> Rash and blister on hand-foot-mouth with fever

**Table 2-2. Waterborne Diseases from Human Enteric Viruses (Continued)**

Group	Subgroup	No. of Types or Subtypes	Disease Entities Associated with These Viruses	Pathological Changes in Patients	Organs Where Virus Multiplies
Enterovirus (continued)	B	6	Pleurodynia <sup>4</sup> Aseptic meningitis Muscular paralysis Meningoencephalitis Pericarditis, endocarditis, myocarditis Respiratory disease  Hepatitis or Rash Spontaneous abortion Insulin-dependent diabetes Congenital heart anomalies	Viral invasion of muscle cells Inflammation of meninges from virus Destruction of motor neurons Viral invasion of cells Viral invasion of cells with secondary inflammatory responses Viral invasion of parenchymatous of respiratory tracts and secondary inflammatory responses Invasion of parenchyma cells Viral invasion of vascular cells Viral invasion of insulin-producing cells Viral invasion of muscle cells	Intercostal muscles Meninges Intestinal mucosa, spinal cord, brain stem Meninges and brains Pericardial and myocardial tissue Respiratory tracts and lungs  Liver Placenta Langerhan's cells of pancreases Developing heart
Reovirus		6	Not well known	Not well known	
Adenovirus		31	Respiratory diseases  Acute conjunctivitis  Acute appendicitis Intussusception Subacute thyroiditis Sarcoma in hamsters	Viral invasion of parenchymatous of respiratory tracts and secondary inflammatory responses Viral invasion of cells and secondary inflammatory responses Viral invasion of mucosa cells Viral invasion of lymph nodes Viral invasion of parenchyma cells Sarcoma in hamsters	Respiratory tracts and lungs  Conjunctival cells and blood vessels  Appendia and lymph nodes Intestinal lymph nodes Thyroid Muscle cells
Hepatitis		>2	Infectious hepatitis Serum hepatitis Down's Syndrome	Invasion of parenchyma cells Invasion of parenchyma cells Invasion of cells	Liver Liver Frontal lobe of brain, muscle, bones

<sup>4</sup> Pleuritis type of pain with fever

Source: Taylor, 1974; Beneson, 1981.

**Table 2-3. Waterborne Diseases from Parasites**

Causative Agent	Disease	Symptoms
<i>Ascario lumbricoides</i> (round worm)	Ascariasis	Vomiting, live worms in feces
<i>Cryptosporidium muris</i> and <i>parvum</i>	Cryptosporidiosis	Acute diarrhea, abdominal pain, vomiting, and low-grade fever. Can be life-threatening in immunodeficient patients
<i>Entamoeba histolytica</i>	Amebiasis	Diarrhea alternating with constipation, chronic dysentery with mucus and blood
<i>Giardia lamblia</i>	Giardiasis	Intermittent diarrhea
<i>Naegleria gruberi</i>	Amoebic meningoencephalitis	Death
<i>Schistosoma mansoni</i>	Schistosomiasis	Liver and bladder infection
<i>Taenia saginata</i> (beef tapeworm)	Taeniasis	Abdominal pain, digestive disturbances, loss of weight

Source: Geldreich, 1972; Beneson, 1981.

### 2.1.1.2 Viruses

Viruses are microorganisms composed of the genetic material deoxyribonucleic acid (DNA) or ribonucleic acid (RNA) and a protective protein coat (either single, double, or partially double stranded). All viruses are obligate parasites, unable to carry out any form of metabolism and are completely dependent upon host cells for replication. Viruses are typically 0.01 to 0.1  $\mu\text{m}$  in size and are very species specific with respect to infection, typically attacking only one type of host. Although the principal modes of transmission for the hepatitis B virus and poliovirus are through food, personal contact, or exchange of body fluids, these viruses can be transmitted through potable water. Some viruses, such as the retroviruses (including the HIV group), appear to be too fragile for water transmission to be a significant danger to public health (Riggs, 1989).

### 2.1.1.3 Protozoa

Protozoa are single-cell eucaryotic microorganisms without cell walls that utilize bacteria and other organisms for food. Most protozoa are free-living in nature and can be encountered in water; however, several species are parasitic and live on or in host organisms. Host organisms can vary from primitive organisms such as algae to highly complex organisms such as human beings. Several species of protozoa known to utilize human beings as hosts are shown in Table 2-5.

**Table 2-4. Attributes of the Three Waterborne Pathogens of Concern in Water Treatment**

Organism	Size (µm)	Mobility	Point(s) of Origin	Resistance to Disinfection	Removal by Sedimentation, Coagulation, and Filtration
Bacteria	0.1–10	Motile, Nonmotile	Humans and animals, water, and contaminated food	Type specific - bacterial spores typically have the highest resistance whereas vegetative bacteria have the lowest resistance	Good, 2 to 3-log removal
Viruses	0.01–0.1	Nonmotile	Humans and animals, polluted water, and contaminated food	Generally more resistant than vegetative bacteria	Poor, 1 to 3-log removal
Protozoa	1–20	Motile, Nonmotile	Humans and animals, sewage, decaying vegetation, and water	More resistant than viruses or vegetative bacteria	Good, 2 to 3-log removal

**Table 2-5. Human Parasitic Protozoans**

Protozoan	Host(s)	Disease	Transmission	Occurrence
<i>Acanthamoeba castellanii</i>	Fresh water, sewage, humans, and soil	Amoebic meningoencephalitis	Gains entry through abrasions, ulcers, and as secondary invader during other infections	North America
<i>Balantidium coli</i>	Pigs, humans	Balantidiasis (dysentery)	Contaminated water	Micronesia has been the only known site of an outbreak
<i>Cryptosporidium parvum</i>	Animals, humans	Cryptosporidiosis	Person-to-person or animal-to-person contact, ingestion of fecally contaminated water or food, or contact with fecally contaminated environmental surfaces.	Canada, England, and the United States
<i>Entamoeba histolytica</i>	Humans	Amoebic dysentery	Contaminated water	Last United States outbreak, 1953
<i>Giardia lamblia</i>	Animals, humans	Giardiasis (gastroenteritis)	Contaminated water	Mexico, United States, USSR
<i>Naegleria fowleri</i>	Soil, water, humans and decaying vegetation	Primary amoebic meningoencephalitis	Nasal inhalation with subsequent penetration of nasopharynx; exposure from swimming in freshwater lakes	North America

Source: Montgomery, 1985; AWWA, 1995.

## 2.1.2 Recent Waterborne Outbreaks

Within the past 40 years, several pathogenic agents never before associated with documented waterborne outbreaks have appeared in the United States. Enteropathogenic *E. coli* and *Giardia lamblia* were first identified to be the etiological agent responsible for waterborne outbreaks in the 1960s. The first recorded *Cryptosporidium* infection in humans occurred in the mid-1970s. Also during that time was the first recorded outbreak of pneumonia caused by *Legionella pneumophila* (Centers for Disease Control, 1989; Witherell et al., 1988). Recently, there have been numerous documented waterborne disease outbreaks that have been caused by *E. coli*, *Giardia lamblia*, *Cryptosporidium*, and *Legionella pneumophila*.

### 2.1.2.1 *E. coli*

The first documented case of waterborne disease outbreaks in the United States associated with enteropathogenic *E. coli* occurred in the 1960s. Various serotypes of *E. coli* have been implicated as the etiological agent responsible for disease in newborn infants, usually the result of cross contamination in nurseries. Now, there have been several well-documented outbreaks of *E. coli* (serotypes 0111:B4 and 0124:B27) associated with adult waterborne disease (AWWA, 1990, and Craun, 1981). In 1975, the etiologic agent of a large outbreak at Crater Lake National Park was *E. coli* serotype 06:H16 (Craun, 1981).

### 2.1.2.2 *Giardia lamblia*

Similar to *E. coli*, *Giardia lamblia* was first identified in the 1960s to be associated with waterborne outbreaks in the United States. *Giardia lamblia* is a flagellated protozoan that is responsible for Giardiasis, a disease that can range from being mildly to extremely debilitating. *Giardia* is currently one of the most commonly identified pathogens responsible for waterborne disease outbreaks. The life cycle of *Giardia* includes a cyst stage when the organism remains dormant and is extremely resilient (i.e., the cyst can survive some extreme environmental conditions). Once ingested by a warm-blooded animal, the life cycle of *Giardia* continues with excystation. The cysts are relatively large (8-14  $\mu\text{m}$ ) and can be removed effectively by filtration using diatomaceous earth, granular media, or membranes.

Giardiasis can be acquired by ingesting viable cysts from food or water or by direct contact with fecal material. In addition to humans, wild and domestic animals have been implicated as hosts. Between 1972 and 1981, 50 waterborne outbreaks of Giardiasis occurred with about 20,000 reported cases (Craun and Jakubowski, 1986). Currently, no simple and reliable method exists to assay *Giardia* cysts in water samples. Microscopic methods for detection and enumeration are tedious and require examiner skill and patience. *Giardia* cysts are relatively resistant to chlorine, especially at higher pH and low temperatures.

### 2.1.2.3 *Cryptosporidium*

*Cryptosporidium* is a protozoan similar to *Giardia*. It forms resilient oocysts as part of its life cycle. The oocysts are smaller than *Giardia* cysts, typically about 4-6 µm in diameter. These oocysts can survive under adverse conditions until ingested by a warm-blooded animal and then continue with excystation.

Due to the increase in the number of outbreaks of Cryptosporidiosis, a tremendous amount of research has focused on *Cryptosporidium* within the last 10 years. Medical interest has increased because of its occurrence as a life-threatening infection to individuals with depressed immune systems. As previously mentioned, in 1993, the largest documented waterborne disease outbreak in United States history occurred in Milwaukee and was determined to be caused by *Cryptosporidium*. An estimated 403,000 people became ill, 4,400 people were hospitalized, and 100 people died. The outbreak was associated with a deterioration in raw water quality and a simultaneous decrease in effectiveness of the coagulation-filtration process, which led to an increase in the turbidity of treated water and inadequate removal of *Cryptosporidium* oocysts.

### 2.1.2.4 *Legionella pneumophila*

An outbreak of pneumonia occurred in 1976 at the annual convention of the Pennsylvania American Legion. A total of 221 people were affected by the outbreak, and 35 of those afflicted died. The cause of the pneumonia was not determined immediately despite an intense investigation by the Centers for Disease Control. Six months after the incident, microbiologists were able to isolate a bacterium from the autopsy lung tissue of one of the Legionnaires. The bacterium responsible to the outbreak was found to be distinct from other known bacterium and was named *Legionella pneumophila* (Witherell et al., 1988). Following the discovery of this organism, other *Legionella*-like organisms were discovered. Altogether, 26 species of *Legionella* have been identified, and seven are etiologic agents for Legionnaires' disease (AWWA, 1990).

Legionnaires' disease does not appear to be transferred person-to-person. Epidemiological studies have shown that the disease enters the body through the respiratory system. *Legionella* can be inhaled in water particles less than 5µm in size from facilities such as cooling towers, hospital hot water systems, and recreational whirlpools (Witherell et al., 1988).

## 2.1.3 Mechanism of Pathogen Inactivation

The three primary mechanisms of pathogen inactivation are to:

- Destroy or impair cellular structural organization by attacking major cell constituents, such as destroying the cell wall or impairing the functions of semi-permeable membranes;
- Interfere with energy-yielding metabolism through enzyme substrates in combination with prosthetic groups of enzymes, thus rendering the enzymes non-functional; and

- Interfere with biosynthesis and growth by preventing synthesis of normal proteins, nucleic acids, coenzymes, or the cell wall.

Depending on the disinfectant and microorganism type, combinations of these mechanisms can also be responsible for pathogen inactivation. In water treatment, it is believed that the primary factors controlling disinfection efficiency are: (1) the ability of the disinfectant to oxidize or rupture the cell wall; and (2) the ability of the disinfectant to diffuse into the cell and interfere with cellular activity (Montgomery, 1985).

## 2.2 Other Uses of Disinfectants in Water Treatment

Disinfectants are used for more than just disinfection in drinking water treatment. While inactivation of pathogenic organisms is a primary function, disinfectants are also used oxidants in drinking water treatment for several other functions:

- Minimization of DBP formation;
- Control of nuisance Asiatic clams and zebra mussels;
- Oxidation of iron and manganese;
- Prevention of regrowth in the distribution system and maintenance of biological stability;
- Removal of taste and odors through chemical oxidation;
- Improvement of coagulation and filtration efficiency;
- Prevention of algal growth in sedimentation basins and filters;
- Removal of color.

A brief discussion of these additional oxidant uses follows.

### 2.2.1 Minimization of DBP Formation

Strong oxidants may play a role in disinfection and DBP control strategies in water treatment. Several strong oxidants, including potassium permanganate and **ozone**, may be used to control DBP precursors.

Potassium permanganate can be used to oxidize organic precursors at the head of the treatment plant, thus minimizing the formation of byproducts at the downstream disinfection stage of the plant. The use of potassium permanganate as an oxidant and disinfectant is discussed in Chapter 5 of this guidance manual.

The use of ozone for oxidation of DBP precursors is currently being studied. Early work has shown that the effects of ozonation, prior to chlorination, were highly site-specific and unpredictable. The key variables that seem to determine the effect of ozone are dose, pH, alkalinity, and the nature of the organic material. Ozone has been shown to be effective for DBP precursor reduction at low pHs. However, at higher pHs (i.e., above 7.5), ozone may actually increase the amount of chlorination byproduct precursors. The use of ozone as an oxidant and disinfectant is addressed in detail in Chapter 3 of this document.

## 2.2.2 Control of Nuisance Asiatic Clams and Zebra Mussels

The Asiatic clam (*Corbicula fluminea*) was introduced to the United States from Southeast Asia in 1938 and now inhabits almost every major river system south of 40° latitude (Britton and Morton, 1982; Counts, 1986). Asiatic clams have been found in the Trinity River, TX; the Ohio River at Evansville, IN; New River at Narrows and Glen Lyn, VA; and the Catawba River in Rock Hill, SC (Belanger et al., 1991; Cameron et al., 1989a; Matisoff et al., 1996). This animal has invaded many water utilities, clogging source water transmission systems and valves, screens, and meters; damaging centrifugal pumps; and causing taste and odor problems (Sinclair, 1964; Evans et al., 1979; Smith, 1979).

Cameron et al. (1989a) investigated the effectiveness of several oxidants to control the Asiatic clam in both the juvenile and adult phases. As expected, the adult clam was found to be much more resistant to oxidants than the juvenile form. In many cases, the traditional method of control, free chlorination, cannot be used because of the formation of excessive amounts of THMs. As shown in Table 2-6, Cameron et al. (1989a) compared the effectiveness of four oxidants for controlling the juvenile Asiatic clam in terms of the LT50 (time required for 50 percent mortality).

Monochloramine was found to be the best for controlling the juvenile clams without forming THMs. Further research showed that the effectiveness of monochloramine increased greatly as the temperature increased (Cameron et al., 1989b). Note that the temperatures in this study reflect conditions in the Lynchburg Reservoir, Houston, Texas. Clams can tolerate temperatures between 2 and 35°C (Cameron et al. 1989a).

**Table 2-6. The Effects of Various Oxidants on Mortality of the Asiatic Clam (*Corbicula fluminea*)**

Chemical	Residual (mg/L)	Temperature (°C)	pH	Life Stage	LT50 (days)
Free chlorine	0.5	23	8.0	A	8.7
	4.8	21	7.9	A	5.9
	4.7	16	7.8	J	4.8
Potassium Permanganate	1.1	17	7.6	J	7.9
	4.8	17	7.6	J	8.6
Monochloramine	2.6	28	7.9	J	0.6
	10.7	17	7.9	J	0.5
Chlorine dioxide	1.2	24	6.9	J	0.7
	4.7	22	6.6	J	0.6

A=Adult; J=Juvenile

Source: Cameron et al., 1989a.

In a similar study, Belanger et al. (1991) studied the biocidal potential of total residual chlorine, monochloramine, monochloramine plus excess ammonia, bromine, and copper for controlling the Asiatic clam. Belanger et al. (1991) showed that monochloramine with excess ammonia was the most effective for controlling the clams at 30°C. Chlorination at 0.25 to 0.40 mg/L total residual chlorine at 20 to 25°C controlled clams of all sizes (LT50 below 28 days) but had minimal effect at 12 to 15°C (as low as zero mortality). As in other studies, the toxicity of all the biocides was highly dependent on temperature and clam size.

The zebra mussel (*Dreissena polymorpha*) is a recent addition to the fauna of the Great Lakes. It was first found in Lake St. Clair in 1988, though it is believed that this native of the Black and Caspian seas, was brought over from Europe in ballast water around 1985 (Herbert et al., 1989). The zebra mussel population in the Great Lakes has expanded very rapidly, both in size and geographical distribution (Roberts, 1990). Lang (1994) reported that zebra mussels have been found in the Ohio River, Cumberland River, Arkansas River, Tennessee River, and the Mississippi River south to New Orleans.

Klerks and Fraleigh (1991) evaluated the effectiveness of hypochlorite, permanganate, and hydrogen peroxide with iron for their effectiveness controlling adult zebra mussels. Both continuous and intermittent 28-day static renewal tests were conducted to determine the impact of intermittent dosing. Intermittent treatment proved to be much less effective than continuous dosing.

The hydrogen peroxide-iron combination (1–5 mg/L with 25 percent iron) was less effective in controlling the zebra mussel than either permanganate or hypochlorite. Permanganate (0.5–2.5 mg KMnO<sub>4</sub>/L) was usually less effective than hypochlorite (0.5–10 mg Cl<sub>2</sub>/L).

Van Benschoten et al. (1995) developed a kinetic model to predict the rate of mortality of the zebra mussel in response to chlorine. The model shows the relationship between chlorine residual and temperature on the exposure time required to achieve 50 and 95 percent mortality. Data were

collected for chlorine residuals between 0.5 and 3.0 mg Cl<sub>2</sub>/L and temperatures from 0.3 to 24°C. The results show a strong dependence on temperature and required contact times ranging from two days to more than a month, depending on environmental factors and mortality required.

Brady et al. (1996) compared the efficiency of chlorine to control growth of zebra mussel and quagga mussel (*Dreissena bugensis*). The quagga mussel is a newly identified mollusk within the Great Lakes that is similar in appearance to the zebra mussel. Full-scale chlorination treatment found a significantly higher mortality for the quagga mussel. The required contact time for 100 percent mortality for quagga and zebra mussels was 23 days and 37 days, respectively, suggesting that chlorination programs designed to control zebra mussels should also be effective for controlling populations of quagga mussels.

Matisoff et al. (1996) evaluated chlorine dioxide (ClO<sub>2</sub>) to control adult zebra mussels using single, intermittent, and continuous exposures. A single 30-minute exposure to 20 mg/L chlorine dioxide or higher concentration induced at least 50 percent mortality, while sodium hypochlorite produced only 26 percent mortality, and permanganate and hydrogen peroxide were totally ineffective when dosed at 30 mg/L for 30 minutes under the same conditions. These high dosages, even though only used for a short period, may not allow application directly in water for certain applications due to byproducts that remain in the water. Continuous exposure to chlorine dioxide for four days was effective at concentrations above 0.5 mg/L (LC50 = 0.35 mg/L), and 100 percent mortality was achieved at chlorine dioxide concentrations above 1 mg/L.

These experiences all show that the dose required to induce mortality to these nuisance organisms is extremely high, both in terms of chemical dose and contact time. The potential impact on DBPs is significant, especially when the water is high in organic content with a high propensity to form THMs and other DBPs.

### 2.2.3 Oxidation of Iron and Manganese

Iron and manganese occur frequently in ground waters but are less problematic in surface waters. Although not harmful to human health at the low concentrations typically found in water, these compounds can cause staining and taste problems. These compounds are readily treated by oxidation to produce a precipitant that is removed in subsequent sedimentation and filtration processes.

Almost all the common oxidants except chloramines will convert ferrous (2+) iron to the ferric (3+) state and manganese (2+) to the (4+) state, which will precipitate as ferric hydroxide and manganese dioxide, respectively (AWWA, 1990). The precise chemical composition of the precipitate will depend on the nature of the water, temperature, and pH.

Table 2-7 shows that oxidant doses for iron and manganese control are relatively low. In addition, the reactions are relatively rapid, on the order of seconds while DBP formation occurs over hours. Therefore, with proper dosing, residual chlorine during iron and manganese oxidation is therefore relatively low and short lived. These factors reduce the potential for DBP formation as a result of oxidation for iron and manganese removal.

**Table 2-7. Oxidant Doses Required for Oxidation of Iron and Manganese**

Oxidant	Iron (II) (mg/mg Fe)	Manganese (II) (mg/mg Mn)
Chlorine, Cl <sub>2</sub>	0.62	0.77
Chlorine dioxide, ClO <sub>2</sub>	1.21	2.45
Ozone, O <sub>3</sub>	0.43	0.88*
Oxygen, O <sub>2</sub>	0.14	0.29
Potassium permanganate, KMnO <sub>4</sub>	0.94	1.92

Source: Culp/Wesner/Culp, 1986; Langlais et al., 1991.

\* Optimum pH for manganese oxidation using ozone is 8-8.5 Source: Reckhow et al., 1991.

## 2.2.4 Prevention of Regrowth in the Distribution System and Maintenance of Biological Stability

Biodegradable organic compounds and ammonia in treated water can cause microbial growth in the distribution system. “Biological stability” refers to a condition wherein the treated water quality does not enhance biological growth in the distribution system. Biological stability can be accomplished in several ways:

- Removing nutrients from the water prior to distribution;
- Maintaining a disinfectant residual in the treated water; and
- Combining nutrient removal and disinfectant residual maintenance.

To maintain biological stability in the distribution system, the Total Coliform Rule (TCR) requires that treated water have a residual disinfectant of 0.2 mg/L when entering the distribution system. A measurable disinfectant residual must be maintained in the distribution system, or the utility must show through monitoring that the heterotrophic plate count (HPC) remains less than 500/100 mL. A system remains in compliance as long as 95 percent of samples meet these criteria. Chlorine, monochloramine, and chlorine dioxide are typically used to maintain a disinfectant residual in the distribution system. Filtration can also be used to enhance biological stability by reducing the nutrients in the treated water.

The level of secondary disinfectant residual maintained is low, typically in the range of 0.1-0.3 mg/L, depending on the distribution system and water quality. However, because the contact times in the system are quite long, it is possible to generate significant amounts of DBPs in the distribution system, even at low disinfectant doses.

Distribution system problems associated with the use of combined chlorine residual (chloramines), or no residual, have been documented in several instances. The use of combined chlorine is characterized by an initial satisfactory phase in which chloramine residuals are easily maintained throughout the system and bacterial counts are very low. However, problems may develop over a

period of years including increased bacterial counts, reduced combined chlorine residual, increased taste and odor complaints, and reduced transmission main carrying capacity. Conversion of the system to free-chlorine residual produces an initial increase in consumer complaints of taste and odors resulting from oxidation of accumulated organic material. Also, it is difficult to maintain a free-chlorine concentration at the ends of the distribution system (AWWA, 1990).

## 2.2.5 Removal of Taste and Odors Through Chemical Oxidation

Tastes and odors in drinking water are caused by several sources, including microorganisms, decaying vegetation, hydrogen sulfide, and specific compounds of municipal, industrial, or agricultural origin. Disinfectants themselves can also create taste and odor problems. In addition to a specific taste-and odor-causing compound, the sensory impact is often accentuated by a combination of compounds. More recently, significant attention has been given to tastes and odors from specific compounds such as geosmin, 2-methylisoborneol (MIB), and chlorinated inorganic and organic compounds (AWWARF, 1987).

Oxidation is commonly used to remove taste and odor causing compounds. Because many of these compounds are very resistant to oxidation, advanced oxidation processes (ozone/hydrogen peroxide, ozone/UV, etc.) and ozone by itself are often used to address taste and odor problems. The effectiveness of various chemicals to control taste and odors can be site-specific. Suffet et al. (1986) found that ozone is generally the most effective oxidant for use in taste and odor treatment. They found ozone doses of 2.5 to 2.7 mg/L and 10 minutes of contact time (residual 0.2 mg/L) significantly reduce levels of taste and odors. Lalezary et al. (1986) used chlorine, chlorine dioxide, ozone, and permanganate to treat earthy-musty smelling compounds. In that study, chlorine dioxide was found most effective, although none of the oxidants were able to remove geosmin and MIB by more than 40 to 60 percent. Potassium permanganate has been used in doses of 0.25 to 20 mg/L. Studies at the Metropolitan Water District of Southern California demonstrated the effectiveness of perozone (ozone plus hydrogen peroxide) to remove geosmin and MIB in water treatment (Ferguson et al., 1990; Ferguson et al., 1991; Huck et al., 1995).

Prior experiences with taste and odor treatment indicate that oxidant doses are dependent on the source of the water and causative compounds. In general, small doses can be effective for many taste and odor compounds, but some of the difficult-to-treat compounds require strong oxidants such as ozone and/or advanced oxidation processes or alternative technologies such as granular activated carbon (GAC) adsorption.

## 2.2.6 Improvement of Coagulation and Filtration Efficiency

Oxidants, specifically ozone, have been reported to improve coagulation and filtration efficiency (Gurol and Pidotella, 1983; Farvardin and Collins, 1990; Reckhow et al., 1993; Masschelein, 1992). Others, however, have found no improvement in effluent turbidity from oxidation (Tobiason et al., 1992; Hildebrand et al., 1986). Prendiville (1986) collected data from a large treatment plant showing that preozonation was more effective than prechlorination to reduce filter effluent turbidities. The cause of

the improved coagulation is not clear, but several possibilities have been offered (Reckhow et al., 1986), including:

- Oxidation of organics into more polar forms;
- Oxidation of metal ions to yield insoluble complexes such as ferric iron complexes; and
- Change in the structure and size of suspended particles.

### **2.2.7 Prevention of Algal Growth in Sedimentation Basins and Filters**

Prechlorination is often used to minimize operational problems associated with biological growth in water treatment plants (AWWA, 1990; Culp/Wesner/Culp, 1986). Prechlorination will prevent slime formation on filters, pipes, and tanks, and reduce potential taste and odor problems associated with such slimes. Many sedimentation and filtration facilities operate with a small chlorine residual to prevent growth of algae and bacteria in the launders and on the filter surfaces. This practice has increased in recent years as utilities take advantage of additional contact time in the treatment units to meet disinfection requirements under the SWTR.

### **2.2.8 Removal of Color**

Free chlorine is used for color removal. A low pH is favored. Color is caused by humic compounds, which have a high potential for DBP formation. The chlorine dosage and kinetics for color removal are best determined through bench studies.

## **2.3 Disinfection Byproducts and Disinfection Residuals**

### **2.3.1 Types of DBPs and Disinfection Residuals**

Table 2-8 is a list, compiled by EPA, of DBPs and disinfection residuals that may be of health concern. The table includes both the disinfectant residuals and the specific byproducts produced by the disinfectants of interest in drinking water treatment. These contaminants of concern are grouped into four distinct categories and include disinfectant residuals, inorganic byproducts, organic oxidation byproducts, and halogenated organic byproducts. Tables 1-3 and 1-4 list the disinfection byproducts and disinfectant residuals that are currently regulated.

**Table 2-8. List of Disinfection Byproducts and Disinfection Residuals**

<b>DISINFECTANT RESIDUALS</b>	<b>HALOGENATED ORGANIC BYPRODUCTS</b>
Free Chlorine Hypochlorous Acid Hypochlorite Ion Chloramines Monochloramine Chlorine Dioxide	Trihalomethanes Chloroform Bromodichloromethane Dibromochloromethane Bromoform Haloacetic Acids Monochloroacetic Acid Dichloroacetic Acid Trichloroacetic Acid Monobromoacetic Acid Dibromoacetic Acid Haloacetonitriles Dichloroacetronitrile Bromochloroacetronitrile Dibromoacetronitrile Trichloroacetronitrile Haloketones 1,1-Dichloropropanone 1,1,1-Trichloropropanone Chlorophenols 2-Chlorophenol 2,4-Dichlorophenol 2,4,6-Trichlorophenol Chloropicrin Chloral Hydrate Cyanogen Chloride N-Organochloramines MX*
<b>INORGANIC BYPRODUCTS</b>	
Chlorate Ion Chlorite Ion Bromate Ion Iodate Ion Hydrogen Peroxide Ammonia	
<b>ORGANIC OXIDATION BYPRODUCTS</b>	
Aldehydes Formaldehyde Acetaldehyde Glyoxal Hexanal Heptanal Carboxylic Acids Hexanoic Acid Heptanoic Acid Oxalic Acid Assimilable Organic Carbon	

\* 3-Chloro-4-(dichloromethyl)-5-hydroxy-2(5H)-furanone

The production of DBPs depend on the type of disinfectant, the presence of organic material (e.g., TOC), bromide ion, and other environmental factors as discussed in this manual. By removing DBP precursors, the formation of DBPs can be reduced.

The health effects of DBPs and disinfectants are generally evaluated with epidemiological studies and/or toxicological studies using laboratory animals. Table 2-9 indicates the cancer classifications of both disinfectants and DBPs as of January 1999. The classification scheme used by EPA is shown at the bottom of Table 2-9. The EPA classification scheme for carcinogenicity weighs both animal studies and epidemiologic studies, but places greater weight on evidence of carcinogenicity in humans.

**Table 2-9. Status of Health Information for Disinfectants and DBPs**

Contaminant	Cancer Classification <sup>(1)</sup>
Chloroform	B2
Bromodichloromethane	B2
Dibromochloromethane	C
Bromoform	B2
Monochloroacetic Acid	--
Dichloroacetic Acid	B2
Trichloroacetic Acid	C
Dichloroacetonitrile	C
Bromochloroacetonitrile	--
Dibromoacetonitrile	C
Trichloroacetonitrile	--
1,1-Dichloropropanone	--
1,1,1-Trichloropropanone	--
2-Chlorophenol	D
2,4-Dichlorophenol	D
2,4,6-Trichlorophenol	B2
Chloropicrin	--
Chloral Hydrate	C
Cyanogen Chloride	--
Formaldehyde	B1 <sup>(2)</sup>
Chlorate	--
Chlorite	D
Bromate	B2
Ammonia	D
Hypochlorous Acid	--
Hypochlorite	--
Monochloramine	--
Chlorine Dioxide	D

(1) The scheme for categorizing chemicals according to their carcinogenic potential is as follows:\*

Group A: Human Carcinogen	Sufficient evidence in epidemiologic studies to support casual association between exposure and cancer.
Group B: Probable Human Carcinogen	Limited evidence in epidemiologic studies (Group B1) and/or sufficient evidence from animal studies (Group B2)
Group C: Possible Human Carcinogen	Limited evidence from animal studies and inadequate or no data in humans
Group D: Not Classifiable	Inadequate or no human and animal evidence of carcinogenicity
Group E: No Evidence of Carcinogenicity for Humans	No evidence of carcinogenicity in at least two adequate animal tests in different species or in adequate epidemiologic and animal studies.

\* EPA is in the process of revising the Cancer Guidelines  
Source: USEPA, 1996

(2) Based on inhalation exposure.

## 2.3.2 Disinfection Byproduct Formation

Halogenated organic byproducts are formed when natural organic matter (NOM) reacts with free chlorine or free bromine. Free chlorine can be introduced to water directly as a primary or secondary disinfectant, with chlorine dioxide, or with chloramines. Free bromine results from the oxidation of the bromide ion in source water. Factors affecting formation of halogenated DBPs include type and concentration of natural organic matter, oxidant type and dose, time, bromide ion concentration, pH, organic nitrogen concentration, and temperature. Organic nitrogen significantly influences the formation of nitrogen containing DBPs such as the haloacetonitriles, halopicrins, and cyanogen halides (Reckhow et al., 1990; Hoigné and Bader, 1988). The parameter TOX represents the concentration of total organic halides in a water sample (calculated as chloride). In general, less than 50 percent of the TOX content has been identified, despite evidence that several of these unknown halogenated byproducts of water chlorination may be harmful to humans (Singer and Chang, 1989).

Non-halogenated DBPs are also formed when strong oxidants react with organic compounds found in water. Ozone and peroxone oxidation of organics leads to the production of aldehydes, aldo- and keto-acids, organic acids, and, when bromide ion is present, brominated organics (Singer, 1992). Many of the oxidation byproducts are biodegradable and appear as biodegradable dissolved organic carbon (BDOC) and assimilable organic carbon (AOC) in treated water.

Bromide ion plays a key role in DBP formation. Ozone or free chlorine oxidizes bromide ion to hypobromate ion/hypobromous acid, which subsequently forms brominated DBPs. Brominated organic byproducts include compounds such as bromoform, brominated acetic acids and acetonitriles, bromopicrin, and cyanogen bromide. Only about one third of the bromide ions incorporated into byproducts has been identified.

### 2.3.2.1 Disinfection Byproduct Precursors

Numerous researchers have documented that NOM is the principal precursor of organic DBP formation (Stevens et al., 1976; Babcock and Singer 1979; Christman et al., 1983). Chlorine reacts with NOM to produce a variety of DBPs, including THMs, haloacetic acids (HAAs), and others. Ozone reacts with NOM to produce aldehydes, organic acids, and aldo- and keto-acids; many of these are produced by chlorine as well (Singer and Harrington, 1993).

Natural waters contain mixtures of both humic and nonhumic organic substances. NOM can be subdivided into a hydrophobic fraction composed of primarily humic material, and a hydrophilic fraction composed of primarily fulvic material.

The type and concentration of NOM are often assessed using surrogate measures. Although surrogate parameters have limitations, they are used because they may be measured more easily, rapidly, and inexpensively than the parameter of interest, often allowing on-line monitoring of the operation and performance of water treatment plants. Surrogates used to assess NOM include:

- Total and dissolved organic carbon (TOC and DOC);

- Specific ultraviolet light absorbance (SUVA), which is the absorbance at 254 nm wavelength (UV-254) divided by DOC ( $SUVA = (UV-254/DOC) \times 100$ , in L/mg-m);
- THM formation potential (THMFP) -- a test measuring the quantity of THMs formed with a high dosage of free chlorine and a long reaction time; and
- TTHM Simulated Distribution System (SDS) -- a test to predict the TTHM concentration at some selected point in a given distribution system, where the conditions of the chlorination test simulate the distribution system at the point desired.

On average, about 90 percent of the TOC is dissolved. DOC is defined as the TOC able to pass through a 0.45  $\mu\text{m}$  filter. UV absorbance is a good technique for assessing the presence of DOC because DOC primarily consists of humic substances, which contain aromatic structures that absorb light in the UV spectrum. Oxidation of DOC reduces the UV absorbance of the water due to oxidation of some of the organic bonds that absorb UV absorbance. Complete mineralization of organic compounds to carbon dioxide usually does not occur under water treatment conditions; therefore, the overall TOC concentration usually is constant.

DBP concentrations vary seasonally and are typically greatest in the summer and early fall for several reasons:

- The rate of DBP formation increases with increasing temperature (Singer et al., 1992);
- The nature of organic DBP precursors varies with season (Singer et al., 1992); and
- Due to warmer temperatures, chlorine demand may be greater during summer months requiring higher dosages to maintain disinfection.

If the bromide ion is present in source waters, it can be oxidized to hypobromous acid that can react with NOM to form brominated DBPs, such as bromoform. Furthermore, under certain conditions, ozone may react with the hypobromite ion ( $\text{OBr}^-$ ) to form bromate ion ( $\text{BrO}_3^-$ ).

The ratio of bromide ion to the chlorine dose affects THM formation and bromine substitution of chlorine. Increasing the bromide ion to chlorine dose ratio shifts the speciation of THMs to produce more brominated forms (Krasner et al., 1989; Black et al., 1996). In the Krasner et al. study, the chlorine dose was roughly proportional to TOC concentration. As TOC was removed through the treatment train, the chlorine dose decreased and TTHM formation declined. However, at the same time, the bromide ion to chlorine dose increased, thereby shifting TTHM concentrations to the more brominated THMs. Therefore, improving the removal of NOM prior to chlorination can shift the speciation of halogenated byproducts toward more brominated forms.

Chloropicrin is produced by the chlorination of humic materials in the presence of nitrate ion (Duguet et al., 1985; Thibaud et al., 1987). Thibaud et al. (1988) chlorinated humic compounds in the presence of bromide ion to demonstrate the formation of brominated analogs to chloropicrin.

### 2.3.2.2 Impacts of pH on DBP Formation

The pH of water being chlorinated has an impact on the formation of halogenated byproducts as shown in Table 2-10 (Reckhow and Singer, 1985; Stevens et al., 1989). THM formation increases with increasing pH. Trichloroacetic acid, dichloroacetonitrile, and trichloropropanone formation decrease with increased pH. Overall TOX formation decreases with increasing pH.

Based on chlorination studies of humic material in model systems, high pH tends to favor chloroform formation over the formation of trichloroacetic acid and other organic halides. Accordingly, water treatment plants practicing precipitative softening at pH values greater than 9.5 to 10 are likely to have a higher fraction of TOX attributable to THMs than plants treating surface waters by conventional treatment in pH ranges of 6 to 8 (Singer and Chang, 1989).

Since the application of chlorine dioxide and chloramines may introduce free chlorine into water, chlorination byproducts that may be formed would be influenced by pH as discussed above. Ozone application to bromide ion containing waters at high pH favors the formation of bromate ion, while application at low pH favors the formation of brominated organic byproducts. See discussion under individual disinfectants for a more detailed discussion on pH impacts on DBP formation.

The pH also impacts enhanced coagulation (i.e., for ESWTR compliance) and Lead and Copper Rule Compliance. These issues are addressed in EPA's *Microbial and Disinfection Byproduct Simultaneous Compliance Guidance Manual* (expected to be available in 1999).

### 2.3.2.3 Organic Oxidation Byproducts

Organic oxidation byproducts are formed by reactions between NOM and all oxidizing agents added during drinking water treatment. Some of these byproducts are halogenated, as discussed in the previous section, while others are not. The types and concentrations of organic oxidation byproducts produced depend on the type and dosage of the oxidant being used, chemical characteristics and concentration of the NOM being oxidized, and other factors such as the pH and temperature.

Specific chemical byproducts belonging to the classification of halogenated organic oxidation products are listed in Table 2-10. As presented in Table 2-10, the formation of DBPs is pH dependent. Comparisons in the table are made to the formation of TTHMs at a pH of 7.0. AOC is not a specific organic contaminant, but a generally used surrogate measure of bacterial regrowth potential in distribution systems. AOC is comprised of many chemical species, including the aldehydes and carboxylic acids listed in Table 2-8. AOC formation studies, primarily performed in the Netherlands, have shown that both ozonation and chlorination can increase concentrations of AOC. This increase in AOC concentration is believed to be the result of oxidizing high molecular weight organics to smaller and more readily bioassimilable molecules. Because AOC is not a specific chemical contaminant, no specific health effects are attributable to AOC.

**Table 2-10. Conditions of Formation of DBPs**

By-product	Conditions of Formation		
	Chlorination at pH 5.0	Chlorination at pH 7.0	Chlorination at pH 9.4
Total Trihalomethanes	Lower formation		Higher formation
Trichloroacetic Acid	Similar formation to that at pH 7.0	Similar formation to that at pH 5.0	Lower formation
Dichloroacetic Acid	Similar formation to that at pH 5.0 and 9.4 - perhaps slightly higher at pH 7.0	Similar formation to that at pH 5.0 and 9.4- perhaps slightly higher at pH 7.0	Similar formation to that at pH 5.0 and 7.0 - perhaps slightly higher at pH 7.0
Monochloroacetic Acid	At concentrations <5 µg/L, trends not discernible	At concentrations <5 µg/L, trends not discernible	At concentrations <5 µg/L, trends not discernible
Dibromoacetic Acid	At concentrations <1 µg/L, trends not discernible	At concentrations <1 µg/L, trends not discernible	At concentrations <1 µg/L, trends not discernible
Chloral Hydrate	Similar formation to that at pH 7.0	Similar formation to that at pH 5.0	Forms within 4 hours; decays over time to <5 µg/L
Chloropicrin	At concentrations <1 µg/L, trends not discernible	At concentrations <1 µg/L, trends not discernible	At concentrations <1 µg/L, trends not discernible
Dichloroacetonitrile	Higher formation	Forms within 4 hours; decays over time to <5 µg/L	Concentrations <2 µg/L, trends not discernible
Bromochloroacetonitrile	At concentrations <2 µg/L, trends not discernible	At concentrations <2 µg/L, trends not discernible	At concentrations <2 µg/L, trends not discernible
Dibromoacetonitrile	At concentrations <.5 µg/L, trends not discernible	At concentrations <.5 µg/L, trends not discernible	At concentrations <.5 µg/L, trends not discernible
Trichloroacetonitrile	Not detected	Not detected	Not detected
1,1,1-Trichloropropanone	Higher formation	At concentrations <2 µg/L, trends not discernible	Not detected

Source: Stevens et al., 1989.

### 2.3.2.4 Inorganic Byproducts and Disinfectants

Table 2-11 shows some of the inorganic DBPs that are produced or remain as residual during disinfection. As discussed earlier, bromide ion reacts with strong oxidants to form bromate ion and other organic DBPs. Chlorine dioxide and chloramines leave residuals that are of concern for health considerations, as well as for taste and odor. The significance of these compounds is discussed further in subsequent chapters.

**Table 2-11. Inorganic DBPs Produced During Disinfection**

Disinfectant	Inorganic Byproduct or Disinfectant Residual Discussed
Chlorine Dioxide	Chlorine Dioxide, Chlorite ion, Chlorate ion, Bromate ion (in presence of light)
<u>Ozone</u>	Bromate ion, Hydrogen Peroxide
Chloramination	Monochloramine, Dichloramine, Trichloramine, Ammonia, Cyanogen Chloride

### 2.3.3 DBP Control Strategies

In 1983, the EPA identified technologies, treatment techniques, and plant modifications that community water systems could use to comply with the maximum contaminant level for TTHMs. The principal treatment modifications involved moving the point of chlorination downstream in the water treatment plant, improving the coagulation process to enhance the removal of DBP precursors, and using chloramines to supplement or replace the use of free chlorine (Singer, 1993). Moving the point of chlorination downstream in the treatment train often is very effective in reducing DBP formation, because it allows the NOM precursor concentration to be reduced during treatment prior to chlorine addition. Replacing prechlorination by preoxidation with an alternate disinfectant that produces less DBPs is another option for reducing formation of chlorinated byproducts.

Other options to control the formation of DBPs include; source water quality control, DBP precursor removal, and disinfection strategy selection. An overview of each is provided below.

#### 2.3.3.1 Source Water Quality Control

Source water control strategies involve managing the source water to lower the concentrations of NOM and bromide ion in the source water. Research has shown that algal growth leads to the production of DBP precursors (Oliver and Shindler, 1980; Wachter and Andelman, 1984; Karimi and Singer, 1991). Therefore, nutrient and algal management is one method of controlling DBP formation potential of source waters. Control of bromide ion in source waters may be accomplished by preventing brine or salt water intrusion into the water source.

#### 2.3.3.2 DBP Precursor Removal

Raw water can include DBP precursors in both dissolved and particulate forms. For the dissolved precursors to be removed in conventional treatment, they must be converted to particulate form for subsequent removal during settling and filtering. The THM formation potential generally decreases by about 50 percent through conventional coagulation and settling, indicating the importance of moving the point of chlorine application after coagulation and settling (and even filtration) to control TOX as well as TTHM formation (Singer and Chang, 1989). Conventional systems can lower the DBP formation potential of water prior to disinfection by further removing precursors with enhanced coagulation, GAC adsorption, or membrane filtration prior to disinfection. Precursor removal efficiencies are site-specific and vary with different source waters and treatment techniques.

Aluminum (alum) and iron (ferric) salts can remove variable amounts of NOM. For alum, the optimal pH for NOM removal is in the range of 5.5 to 6.0. The addition of alum decreases pH and may allow the optimal pH range to be reached without acid addition. However, waters with very low or very high alkalinities may require the addition of base or acid to reach the optimal NOM coagulation pH (Singer, 1992).

GAC adsorption can be used following filtration to remove additional NOM. For most applications, empty bed contact times in excess of 20 minutes are required, with regeneration frequencies on the order of 2 to 3 months (Singer, 1992). These long contact times and frequent regeneration requirements make GAC an expensive treatment option. In cases where prechlorination is practiced, the chlorine rapidly degrades GAC. Addition of a disinfectant to the GAC bed can result in specific reactions in which previously absorbed compounds leach into the treated water.

Membrane filtration has been shown effective in removing DBP precursors in some instances. In pilot studies, ultrafiltration (UF) with a molecular weight cutoff (MWCO) of 100,000 daltons was ineffective for controlling DBP formation. However, when little or no bromide ion was present in source water, nanofiltration (NF) membranes with MWCOs of 400 to 800 daltons effectively controlled DBP formation (Lainé et al., 1993). In waters containing bromide ion, higher bromoform concentrations were observed after chlorination of membrane permeate (compared with raw water). This occurs as a result of filtration removing NOM while concentrating bromide ions in the permeate thus providing a higher ratio of bromide ions to NOM than in raw water. This reduction in chlorine demand increases the ratio of bromide to chlorine, resulting in higher bromoform concentrations after chlorination of NF membrane permeate (compared with the raw water). TTHMs were lower in chlorinated permeate than chlorinated raw water. However, due to the shift in speciation of THMs toward more brominated forms, bromoform concentrations were actually greater in chlorinated treated water than in chlorinated raw water. Use of spiral-wound NF membranes (200–300 daltons) more effectively controlled the formation of brominated THMs, but pretreatment of the water was necessary (Lainé et al., 1993). Significant limitations in the use of membranes are disposal of the waste brine generated, fouling of membranes, cost of membrane replacement, and increasing energy cost.

The promulgated DBPR requires enhanced coagulation as an initial step for removal of DBP precursors. In addition to meeting MCLs and MRDLs, some water suppliers also must meet treatment requirements to control the organic material (DBP precursors) in the raw water that combines with disinfectant residuals to form DBPs. Systems using conventional treatment are required to control precursors (measured as TOC) by using enhanced coagulation or enhanced softening. A system must remove a specified percentage of TOC (based on raw water quality) prior to the point of continuous disinfection (Table 2-12).

Systems using ozone followed by biologically active filtration or chlorine dioxide that meet specific criteria would be required to meet the TOC removal requirements prior to addition of a residual disinfectant. Systems able to reduce TOC by a specified percentage level have met the DBPR treatment technique requirement.

**Table 2-12. Required Removal of TOC by Enhanced Coagulation for Surface Water Systems<sup>+</sup> Using Conventional Treatment<sup>++</sup> (percent reduction)**

Source Water TOC (mg/L)	Source Water Alkalinity (mg/L as CaCO <sub>3</sub> )		
	0-60	>60-120	>120 <sup>+++</sup>
>2.0-4.0	35.0	25.0	15.0
>4.0-8.0	45.0	35.0	25.0
>8.0	50.0	40.0	30.0

+ Also applies to utilities that treat ground water under the influence of surface water.

++ Systems meeting at least one of the conditions in 40 CFR §§ 141.135(a)(1)(i)-(iv) are not required to operate with enhanced coagulation.

+++ Systems practicing precipitative softening must meet the TOC removal requirements in this column.

If the system does not meet the percent reduction, it must determine its alternative minimum TOC removal level. The primacy agency approves the alternative minimum TOC removal possible for the system on the basis of the relationship between coagulant dose and TOC in the system based on results of bench or pilot-scale testing. Enhanced coagulation is determined in part as the coagulant dose where an incremental addition of 10 mg/L of alum (or an equivalent amount of ferric salt) results in a TOC removal below 0.3 mg/L.

### 2.3.3.3 Disinfection Strategy Selection

In addition to improving the raw or pre-disinfectant water quality, alternative disinfection strategies can be used to control DBPs. These strategies include the following:

- Use an alternative or supplemental disinfectant or oxidant such as chloramines or chlorine dioxide that will produce fewer DBPs;
- Move the point of chlorination to reduce TTHM formation and, where necessary, substitute chloramines, chlorine dioxide, or potassium permanganate for chlorine as a preoxidant;
- Use two different disinfectants or oxidants at various points in the treatment plant to avoid DBP formation at locations where precursors are still present in high quantities;
- Use of powdered activated carbon for THM precursor or TTHM reduction seasonally or intermittently; and
- Maximize precursor removal.

### 2.3.4 CT Factor

One of the most important factors for determining or predicting the germicidal efficiency of any disinfectant is the CT factor, a version of the Chick-Watson law (Chick, 1908; Watson, 1908). The CT factor is defined as the product of the residual disinfectant concentration, C, in mg/L, and the contact time, T, in minutes, that residual disinfectant is in contact with the water.

EPA developed CT values for the inactivation of *Giardia* and viruses under the SWTR. Table 2-13 compares the CT values for virus inactivation using chlorine, chlorine dioxide, ozone, chloramine, and ultraviolet light disinfection under specified conditions. Table 2-14 shows the CT values for inactivation of *Giardia* cyst using chlorine, chloramine, chlorine dioxide, and ozone under specified conditions. The CT values shown in Table 2-13 and Table 2-14 are based on water temperatures of 10°C and pH values in the range of 6 to 9. CT values for chlorine disinfection are based on a free chlorine residual. Note that chlorine is less effective as pH increases from 6 to 9. In addition, for a given CT value, a low C and a high T is more effective than the reverse (i.e., a high C and a low T). For all disinfectants, as temperature increases, effectiveness increases.

**Table 2-13. CT Values for Inactivation of Viruses**

Disinfectant	Units	Inactivation		
		2-log	3-log	4-log
Chlorine <sup>1</sup>	mg · min/L	3	4	6
Chloramine <sup>2</sup>	mg · min/L	643	1,067	1,491
Chlorine Dioxide <sup>3</sup>	mg · min/L	4.2	12.8	25.1
<u>Ozone</u>	mg · min/L	0.5	0.8	1.0
UV	mW · s/cm <sup>2</sup>	21	36	not available

CT values were obtained from AWWA, 1991.

<sup>1</sup> Values are based on a temperature of 10°C, pH range of 6 to 9, and a free chlorine residual of 0.2 to 0.5 mg/L.

<sup>2</sup> Values are based on a temperature of 10°C and a pH of 8.

<sup>3</sup> Values are based on a temperature of 10°C and a pH range of 6 to 9.

**Table 2-14. CT Values for Inactivation of *Giardia* Cysts**

Disinfectant	Inactivation (mg · min/L)					
	0.5-log	1-log	1.5-log	2-log	2.5-log	3-log
Chlorine <sup>1</sup>	17	35	52	69	87	104
Chloramine <sup>2</sup>	310	615	930	1,230	1,540	1,850
Chlorine Dioxide <sup>3</sup>	4	7.7	12	15	19	23
Ozone <sup>3</sup>	0.23	0.48	0.72	0.95	1.2	1.43

CT values were obtained from AWWA, 1991.

<sup>1</sup> Values are based on a free chlorine residual less than or equal to 0.4 mg/L, temperature of 10°C, and a pH of 7.

<sup>2</sup> Values are based on a temperature of 10°C and a pH in the range of 6 to 9.

<sup>3</sup> Values are based on a temperature of 10°C and a pH of 6 to 9.

## 2.4 Pathogen Inactivation Versus DBP Formation

Table 2-15 presents a summary of disinfection parameter impacts on pathogen inactivation and DBP formation.

**Table 2-15. Summary of Disinfection Impacts**

Disinfection Parameter	Typical Impact on Pathogen Inactivation	Typical Impact on DBP Formation
Disinfectant Type	Depends on inactivation efficacy	Depends on disinfectant reactivity
Disinfectant Strength	The stronger the disinfectant, the quicker the disinfection process.	The stronger the disinfectant, the greater the amount of DBPs.
Disinfectant Dose	Increasing the disinfectant dose increases the disinfection rate.	Increasing the disinfectant dose typically increases the rate of DBP formation.
Type of Organism	Susceptibility to disinfection varies according to pathogen group. In general, protozoa are more resistant to disinfectants than bacteria and viruses.	None.
Contact Time	Increasing the contact time decreases the disinfectant dose required for a given level of inactivation.	Increasing contact time with an equivalent disinfectant dose increases the formation of DBPs.
pH	pH may affect the disinfectant form and, in-turn, the efficiency of the disinfectant.	The impact of pH varies with DBP. See Section 2.3.2.3 for a brief summary of relationships between pH and DBP formation.
Temperature	Increasing the temperature increases the rate of disinfection.	Increasing temperature is typically associated with faster oxidation kinetics, hence, increased DBP formation.
Turbidity	Particles responsible for turbidity can surround and shield pathogenic microorganisms from disinfectants.	Increased turbidity may be associated with increased NOM, which represents an increased amount of DBP precursors for the formation of DBPs when disinfectant is applied.
Dissolved Organics	Dissolved organics can interfere with disinfection by creating a demand and reducing the amount of disinfectant available for pathogen inactivation.	Increased dissolved organics will represent a larger amount of DBP precursor for the formation of DBPs when disinfectant is applied.

## 2.5 Disinfectant Residual Regulatory Requirements

One of the most important factors for evaluating the merits of alternative disinfectants is their ability to maintain the microbial quality in the water distribution system. Disinfectant residuals may serve to protect the distribution system against regrowth (Snead et al., 1980). The SWTR requires that filtration and disinfection must be provided to ensure that the total treatment of the system achieves at least a 3-log removal/inactivation of *Giardia* cysts and a 4-log removal/inactivation of viruses. In addition, the disinfection process must demonstrate by continuous monitoring and recording that the disinfectant residual in the water entering the distribution system is never less than 0.2 mg/L for more than 4 hours.

Several of the alternative disinfectants examined in this manual cannot be used to meet the residual requirements stated in the SWTR. For example, if either ozone or ultraviolet light disinfection are used as the primary disinfectant, a secondary disinfectant such as chlorine or chloramines should be utilized to obtain a residual in the distribution system.

DBP formation continues in the distribution system due to reactions between the residual disinfectant and organics in the water. Koch et al. (1991) found that with a chlorine dose of 3-4 mg/L, THM and HAA concentrations increase rapidly during the first 24 hours in the distribution system. After the initial 48 hours, the subsequent increase in THMs is very small. Chloral hydrate concentrations continued to increase after the initial 24 hours, but at a reduced rate. Haloketones actually decreased in the distribution system.

Nieminski et al. (1993) evaluated DBP formation in the simulated distribution systems of treatment plants in Utah. Finished water chlorine residuals ranged from 0.4 to 2.8 mg/L. Generally, THM values in the distribution system studies increased by 50 to 100 percent (range of 30 to 200 percent) of the plant effluent value after 24-hour contact time. The 24-hour THM concentration was essentially the same as the 7-day THM formation potential. HAA concentrations in the simulated distribution system was about 100 percent (range of 30 to 200 percent) of the HAA in the plant effluent. The 7-day HAA formation potential was sometimes higher, or below the distribution system values. If chlorine is used as a secondary disinfectant, one should therefore anticipate a 100-percent increase in the plant effluent THMs, or plan to reach the 7-day THM formation level in the distribution system.

## 2.6 Summary of Current National Disinfection Practices

Most water treatment plants disinfect water prior to distribution. The 1995 Community Water Systems Survey (USEPA, 1997a) reports that 81 percent of all community water systems provide some form of treatment on all or a portion of their water sources. The survey also found that virtually all surface water systems provide some treatment of their water. Of those systems reporting no treatment, 80 percent rely on ground water as their only water source.

The most commonly used disinfectants/oxidants are chlorine, chlorine dioxide, chloramines, ozone, and potassium permanganate. Table 2-16 shows a breakdown on the chemical usage from the survey. Note that the table shows the percentages of systems using the particular chemical as either disinfectant or some other role. The table shows the predominance of chlorine in surface and ground water disinfection treatment systems with more than 60 percent of the treatment systems using chlorine as disinfectant/oxidant. Potassium permanganate on the other hand, is used by many systems, but its application is primarily for oxidation, rather than for disinfection.

Permanganate will have some beneficial impact on disinfection since it is a strong oxidant that will reduce the chemical demand for the ultimate disinfection chemical. Chloramine is used by some systems and is more frequently used as a post-treatment disinfectant.

The International Ozone Association conducted a survey of ozone facilities in the United States (IOA, 1997). The survey documented the types of ozone facilities, size, objective of ozone application, and year of operation. Table 2-17 summarizes the findings from the survey. The most common use for ozone is for oxidation of iron and manganese, and for taste and odor control. Twenty-four of the 158 ozone facilities used GAC following ozonation. In addition to the 158

operating ozone facilities, the survey identified 19 facilities under construction and another 30 under design. The capacity of the systems range from less than 25 gpm to exceeding 500 mgd. Nearly half of the operating facilities have a capacity exceeding 1 mgd. Rice et al. (1998) found that as of May 1998, 264 drinking water plants in the United States are using ozone.

**Table 2-16. Disinfection Practices of Water Systems that Include Some Form of Treatment**

Treatment	Service Population								Total
	<100	101-500	501-1,000	1,001-3,300	3,301-10,000	10,001-50,000	50,001-100,000	Over 100,001	
<b>Surface Water Systems</b>									
<b>Total Number of Systems</b>	218	432	330	845	679	626	103	104	3,337
<b>Pre-Disinfection, Oxidation/Softening</b>									
Chlorine	59.0%	73.9%	67.3%	66.3%	68.8%	58.6%	47.5%	57.1%	63.8%
Chlorine dioxide	0	0	0	5.0	4.7	13.2	14.2	7.8	6.3
Chloramines	4.6	0	1.1	2.1	0	2.2	15.5	10.8	3.1
Ozone	0	0	0	0	0.3	0	5.4	5.8	0.9
KMnO <sub>4</sub>	0	4.9	9.6	9.9	15.2	28.3	25.9	28.5	16.0
Predisinfection/oxidation	0	0	2.0	2.9	0.6	9.2	5.1	4.3	3.5
Lime/Soda ash softening	6.8	9.8	20.9	16.2	14.3	11.7	3.5	5.9	12.5
Recarbonation	0	0	0	0	2.1	4.7	0.6	6.3	1.9
<b>Post-Disinfection</b>									
Chlorine	49.7 %	51.6%	80.6%	62.8%	77.9%	71.1%	73.8 %	63.6 %	67.5 %
Chlorine dioxide	0	0	0	0	0.3	4.9	5.9	11.2	1.6
Chloramines	0	0	0	2.9	2.1	15.6	29.4	24.2	8.1
Postdisinfection combinations	0	0	0	2.1	4.0	3.9	1.9	1.6	3.0
<b>Ground Water Systems</b>									
<b>Total Number of Systems</b>	9,042	10,367	4,443	4,422	2,035	1,094	120	56	31,579
<b>Pre-Disinfection, Oxidation/Softening</b>									
Chlorine	64.2 %	69.9 %	56.7 %	73.2 %	60.6 %	57.4 %	36.2 %	38.1 %	63.9 %
Chlorine dioxide	1.3	0	0	0	0	0	3.1	0	0.3
Chloramines	0	0	0	0	0	0.6	1.4	0.7	0.1
Ozone	0	0	0	0	0	0	0	0.6	0
KMnO <sub>4</sub>	0	0.9	2.2	0.6	5.8	3.2	7.0	0	1.8
Predisinfection/oxidation	0.3	0.5	0	0.7	1.0	2.6	0	0	0.7
Lime/Soda ash softening	2.9	2.9	2.2	3.6	3.5	3.8	5.0	9.1	3.2
Recarbonation	0	0.5	0	0.6	1.4	1.5	2.8	1.1	0.6
<b>Post-Disinfection</b>									
Chlorine	23.0 %	23.4%	32.5%	28.3 %	42.5%	41.9 %	54.5 %	65.8 %	31.0 %
Chlorine dioxide	0	1.0	0	0	0	0.6	0	0	0.4
Chloramines	0	0	0	0	0.1	1.1	3.9	4.3	0.3
Postdisinfection combinations	0	0	0	0	0.1	0.1	0	0	0

Source: USEPA, 1997a.

**Table 2-17. Ozone Application in Water Treatment Plants in the United States**

Ozone Objective	Number of Plants	% Plants
THM Control	50	32
Disinfection	63	40
Iron/Manganese, Taste and Odor Control	92	58
Total	158	--

Source: IOA, 1997.

## 2.7 Chlorine

Although chlorine is not a focus of this guidance manual, the following section provides a brief overview of chlorine use in the water treatment industry to compare with the alternative disinfectants discussed in this manual. Since there is a wealth of excellent literature on chlorine's uses and performance capabilities, summarizing this large body of knowledge here is neither practical nor necessary (see, for example: White, 1992; Chlorine Institute, 1996; and Connell, 1996).

One of the recent developments in chlorine disinfection is the use of multiple and interactive disinfectants. In these applications, chlorine is combined with a second disinfectant to achieve improved disinfection efficiency and/or effective DBP control. A detailed discussion on multiple disinfectants, including chlorine combinations, is provided in Chapter 9.

As described earlier, the 1995 Community Water System Survey (USEPA, 1997a), indicated that the majority of all surface water and ground water systems in the United States use chlorine for disinfection.

Chlorine has many attractive features that contribute to its wide use in the industry. Four of the key attributes of chlorine are that it:

- Effectively inactivates a wide range of pathogens commonly found in water;
- Leaves a residual in the water that is easily measured and controlled;
- Is economical; and
- Has an extensive track record of successful use in improving water treatment operations (despite the dangers associated with chlorine application and handling, specifically chlorine gas, it still maintains an excellent safety record).

There are, however, some concerns regarding chlorine usage that may impact its uses such as:

- Chlorine reacts with many naturally occurring organic and inorganic compounds in water to produce undesirable DBPs;
- Hazards associated with using chlorine, specifically chlorine gas, require special treatment and response programs; and
- High chlorine doses can cause taste and odor problems.

Chlorination is used in water treatment facilities primarily for disinfection. Because of chlorine's oxidizing powers, it has been found to serve other useful purposes in water treatment, such as (White, 1992):

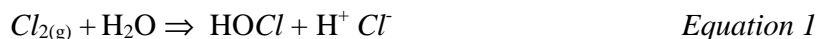
- Taste and odor control;
- Prevention of algal growths;
- Maintenance of clear filter media;
- Removal of iron and manganese;
- Destruction of hydrogen sulfide;
- Bleaching of certain organic colors;
- Maintenance of distribution system water quality by controlling slime growth;
- Restoration and preservation of pipeline capacity;
- Restoration of well capacity, water main sterilization; and
- Improved coagulation by activated silica.

## 2.7.1 Chlorine Chemistry

Chlorine for disinfection typically is used in one of three forms: chlorine gas, sodium hypochlorite, or calcium hypochlorite. A brief description of the chemistry of these three chemicals is provided below.

### 2.7.1.1 Chlorine Gas

Chlorine gas hydrolyzes rapidly in water to form hypochlorous acid (HOCl). The following equation presents the hydrolysis reaction:



Note that the addition of chlorine gas to water reduces the pH of the water due to the production of hydrogen ion.

Hypochlorous acid is a weak acid ( $\text{pK}_a$  of about 7.5), meaning it dissociates slightly into hydrogen and hypochlorite ions as noted in Equation 2:



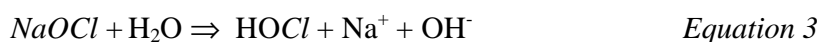
Between a pH of 6.5 and 8.5 this dissociation is incomplete and both HOCl and OCl<sup>-</sup> species are present to some extent (White, 1992). Below a pH of 6.5, no dissociation of HOCl occurs, while above a pH of 8.5, complete dissociation to OCl<sup>-</sup> occurs. As the germicidal effects of HOCl is much higher than that of OCl<sup>-</sup>, chlorination at a lower pH is preferred.

### 2.7.1.2 Hypochlorite

In addition to chlorine gas, chlorine is also available in hypochlorite form as both aqueous solutions and dry solids. The most common aqueous hypochlorite solution is sodium hypochlorite. The most common form of dry solid hypochlorite is calcium hypochlorite (White, 1992).

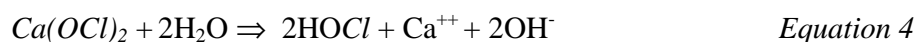
**Sodium Hypochlorite.** Sodium hypochlorite is produced when chlorine gas is dissolved in a sodium hydroxide solution. Sodium hypochlorite solution typically contains 12.5 percent available chlorine (White, 1992). One gallon of 12.5 percent sodium hypochlorite solution typically contains the equivalent of one pound of chlorine.

The reaction between sodium hypochlorite and water is shown in the following reaction:



Equation 3 shows that the application of sodium hypochlorite to water produces hypochlorous acid, similar to chlorine gas hydrolysis (Equation 1). However, unlike chlorine hydrolysis, the addition of sodium hypochlorite to water yields a hydroxyl ion that will increase the pH of the water. In addition, excess sodium hydroxide is used to manufacture sodium hypochlorite, which will further increase the pH of the water.

**Calcium Hypochlorite.** Calcium hypochlorite is formed from the precipitate that results from dissolving chlorine gas in a solution of calcium oxide (lime) and sodium hydroxide. Granular calcium hypochlorite commercially available typically contains 65 percent available chlorine. This means that 1.5 pounds of calcium hypochlorite contains the equivalent of one pound of chlorine. The reaction between calcium hypochlorite and water is shown in the following reaction:



Equation 4 shows that the application of calcium hypochlorite to water also produces hypochlorous acid, similar to chlorine gas hydrolysis (Equation 1). Similar to sodium hypochlorite solution, the addition of calcium hypochlorite to water yields hydroxyl ions that will increase the pH of the water.

## 2.7.2 Chlorine Generation

Onsite generation of chlorine has recently become practical. These generation systems, using only salt and electric power, can be designed to meet disinfection and residual standards and to operate unattended at remote sites. Considerations for chlorine generation include cost, concentration of the brine produced, availability of raw materials, and the reliability of the process (AWWA and ASCE, 1997).

### 2.7.2.1 Chlorine

Chlorine gas can be generated by a number of processes including the electrolysis of alkaline brine or hydrochloric acid, the reaction between sodium chloride and nitric acid, or the oxidation of

hydrochloric acid. About 70 percent of the chlorine produced in the United States is manufactured from the electrolysis of salt brine and caustic solutions in a diaphragm cell (White, 1992). Since chlorine is a stable compound, it is typically produced off-site by a chemical manufacturer. Once produced, chlorine is packaged as a liquefied gas under pressure for delivery to the site in railcars, tanker trucks, or cylinders.

### **2.7.2.2 Sodium Hypochlorite**

Dilute sodium hypochlorite solutions (less than 1 percent) can be generated electrochemically on-site from salt brine solution. Typically, sodium hypochlorite solutions are referred to as liquid bleach or Javelle water. Generally, the commercial or industrial grade solutions produced have hypochlorite strengths of 10 to 16 percent. The stability of sodium hypochlorite solution depends on the hypochlorite concentration, the storage temperature, the length of storage (time), the impurities of the solution, and exposure to light. Decomposition of hypochlorite over time can affect the feed rate and dosage, as well as produce undesirable byproducts such as chlorite ions or chlorate (Gordon et al., 1995). Because of the storage problems, many systems are investigating onsite generation of hypochlorite in lieu of its purchase from a manufacturer or vendor (USEPA, 1998b).

### **2.7.2.3 Calcium Hypochlorite**

To produce calcium hypochlorite, hypochlorous acid is made by adding chlorine monoxide to water and then neutralizing it with a lime slurry to create a solution of calcium hypochlorite. The water is removed from the solution, leaving granulated calcium hypochlorite. Generally, the final product contains up to 70 percent available chlorine and 4 to 6 percent lime. Storage of calcium hypochlorite is a major safety consideration. It should never be stored where it is subject to heat or allowed to contact any organic material of an easily oxidized nature (USEPA, 1998b).

## **2.7.3 Primary Uses and Points of Application of Chlorine**

### **2.7.3.1 Uses**

The main usage of chlorine in drinking water treatment is for disinfection. However, chlorine has also found application for a variety of other water treatment objectives such as, the control of nuisance organisms, oxidation of taste and odor compounds, oxidation of iron and manganese, color removal, and as a general treatment aid to filtration and sedimentation processes (White, 1992; Connell, 1996; Culp/Wesner/Culp, 1986). Table 2-18 presents a summary of chlorine uses and doses.

**Table 2-18. Chlorine Uses and Doses**

Application	Typical Dose	Optimal pH	Reaction Time	Effectiveness	Other Considerations
Iron	0.62 mg/mg Fe	7.0	less than 1 hour	Good	
Manganese	0.77 mg/mg Mn	7–8 9.5	1–3 hour minutes	Slow kinetics	Reaction time increases at lower pH
Biological growth	1–2 mg/L	6–8	NA	Good	DBP formation
Taste/odor	Varies	6–8	Varies	Varies	Effectiveness depends on compound
Color removal	Varies	4.0–6.8	Minutes	Good	DBP formation
Zebra mussels	2–5 mg/L 0.2–0.5 mg/L <sup>(a)</sup>		Shock level Maintenance level	Good	DBP formation
Asiatic clams	0.3–0.5 mg/L <sup>(a)</sup>		Continuous	Good	DBP formation

Notes:

<sup>(a)</sup> Residual, not dose

Sources: Adapted in part from White, 1992; Connell, 1996; Culp/Wesner/Culp, 1986.

### 2.7.3.2 Points of Application

At conventional surface water treatment plants, chlorine is typically added for prechlorination at either the raw water intake or flash mixer, for intermediate chlorination ahead of the filters, for postchlorination at the filter clearwell, or for rechlorination of the distribution system (Connell, 1996). Table 2-19 summarizes the typical uses for each point of application.

**Table 2-19. Typical Chlorine Points of Application and Uses**

Point of Application	Typical Uses
Raw Water Intake	Zebra mussel and Asiatic clam control, control biological growth
Flash Mixer (prior to sedimentation)	Disinfection, iron and manganese oxidation, taste and odor control, oxidation of hydrogen sulfide
Filter Influent	Disinfection, control biological growth in filter, iron and manganese oxidation, taste and odor control, algae control, color removal
Filter Clearwell	Disinfection
Distribution System	Maintain disinfectant residual

Sources: Connell, 1996; White, 1992; AWWA, 1990.

### 2.7.3.3 Typical Doses

Table 2-20 shows the typical dosages for the various forms of chlorine. The wide range of chlorine gas dosages most likely represents its use as both an oxidant and a disinfectant. While sodium hypochlorite and calcium hypochlorite can also serve as both an oxidant and a disinfectant, their higher cost may limit their use.

**Table 2-20. Typical Chlorine Dosages at Water Treatment Plants**

Chlorine Compound	Range of Doses
Calcium hypochlorite	0.5–5 mg/L
Sodium hypochlorite	0.2–2 mg/L
Chlorine gas	1–16 mg/L

Source: SAIC, 1998, as adapted from EPA's review of public water systems' Initial Sampling Plans which were required by EPA's Information Collection Rule (ICR)

## 2.7.4 Pathogen Inactivation and Disinfection Efficacy

### 2.7.4.1 Inactivation Mechanisms

Research has shown that chlorine is capable of producing lethal events at or near the cell membrane as well as affecting DNA. In bacteria, chlorine was found to adversely affect cell respiration, transport, and possibly DNA activity (Haas and Engelbrecht, 1980). Chlorination was found to cause an immediate decrease in oxygen utilization in both *Escherichia coli* and *Candida parapsilosis* studies. The results also found that chlorine damages the cell wall membrane, promotes leakage through the cell membrane, and produces lower levels of DNA synthesis for *Escherichia coli*, *Candida parapsilosis*, and *Mycobacterium fortuitum* bacteria. This study also showed that chlorine inactivation is rapid and does not require bacteria reproduction (Haas and Engelbrecht, 1980). These observations rule out mutation or lesions as the principal inactivation mechanisms since these mechanisms require at least one generation of replication for inactivation to occur.

### 2.7.4.2 Environmental Effects

Several environmental factors influence the inactivation efficiency of chlorine, including water temperature, pH, contact time, mixing, turbidity, interfering substances, and the concentration of available chlorine. In general, the highest levels of pathogen inactivation are achieved with high chlorine residuals, long contact times, high water temperature, and good mixing, combined with a low pH, low turbidity, and the absence of interfering substances. Of the environmental factors, pH and temperature have the most impact on pathogen inactivation by chlorine. The effect of pH and temperature on pathogen inactivation are discussed below.

**pH.** The germicidal efficiency of hypochlorous acid (HOCl) is much higher than that of the hypochlorite ion (OCl<sup>-</sup>). The distribution of chlorine species between HOCl and OCl<sup>-</sup> is determined by pH, as discussed above. Because HOCl dominates at low pH, chlorination provides more effective disinfection at low pH. At high pH, OCl<sup>-</sup> dominates, which causes a decrease in disinfection efficiency.

The inactivation efficiency of gaseous chlorine and hypochlorite is the same at the same pH after chlorine addition. Note, however, that addition of gaseous chlorine will decrease the pH (see Equation 1) while the addition of hypochlorite will increase the pH of the water (see Equation 3 and

Equation 4). Therefore, without pH adjustment to maintain the same treated water pH, gaseous chlorine will have greater disinfection efficiency than hypochlorite.

The impact of pH on chlorine disinfection has been demonstrated in the field. For example, virus inactivation studies have shown that 50 percent more contact time is required at pH 7.0 than at pH 6.0 to achieve comparable levels of inactivation. These studies also demonstrated that a rise in pH from 7.0 to 8.8 or 9.0 requires six times the contact time to achieve the same level of virus inactivation (Culp and Culp, 1974). Although these studies found a decrease in inactivation with increasing pH, some studies have shown the opposite effect. A 1972 study reported that viruses were more sensitive to free chlorine at high pH than at low pH (Scarpino et al., 1972).

**Temperature.** For typical drinking water treatment temperatures, pathogen inactivation increases with temperature. Virus studies indicate that the contact time should be increased by two to three times to achieve comparable inactivation levels when the water temperature is lowered by 10°C (Clarke et al., 1962).

### 2.7.4.3 Disinfection Efficacy

Since its introduction, numerous investigations have been made to determine the germicidal efficiency of chlorine. Although there are widespread differences in the susceptibility of various pathogens, the general order of increasing chlorine disinfection difficulty are bacteria, viruses, and then protozoa.

**Bacteria Inactivation.** Chlorine is an extremely effective disinfectant for inactivating bacteria. A study conducted during the 1940s investigated the inactivation levels as a function of time for *E. coli*, *Pseudomonas aeruginosa*, *Salmonella typhi*, and *Shigella dysenteriae* (Butterfield et al., 1943). Study results indicated that HOCl is more effective than OCl<sup>-</sup> for inactivation of these bacteria. These results have been confirmed by several researchers that concluded that HOCl is 70 to 80 times more effective than OCl<sup>-</sup> for inactivating bacteria. (Culp/Wesner/Culp, 1986).

**Virus Inactivation.** Chlorine has been shown to be a highly effective viricide. One of the most comprehensive virus studies was conducted in 1971 using treated Potomac estuary water (Liu et al., 1971). The tests were performed to determine the resistance of 20 different enteric viruses to free chlorine under constant conditions of 0.5 mg/L free chlorine and a pH and temperature of 7.8 and 2°C, respectively. In this study, the least resistant virus was found to be reovirus and required 2.7 minutes to achieve 99.99 percent inactivation (4 log removal). The most resistant virus was found to be a poliovirus, which required more than 60 minutes for 99.99 inactivation. The corresponding CT range required to achieve 99.99 percent inactivation for all 20 viruses was between 1.4 to over 30 mg·min/L.

Virus survival studies have also been conducted on a variety of both laboratory and field strains (AWWA, 1979). All of the virus inactivation tests in this study were performed at a free chlorine residual of 0.4 mg/L, a pH of 7.0, a temperature of 5°C, and contact times of either 10, 100, or 1,000 minutes. Test results showed that of the twenty cultures tested only two poliovirus strains reached

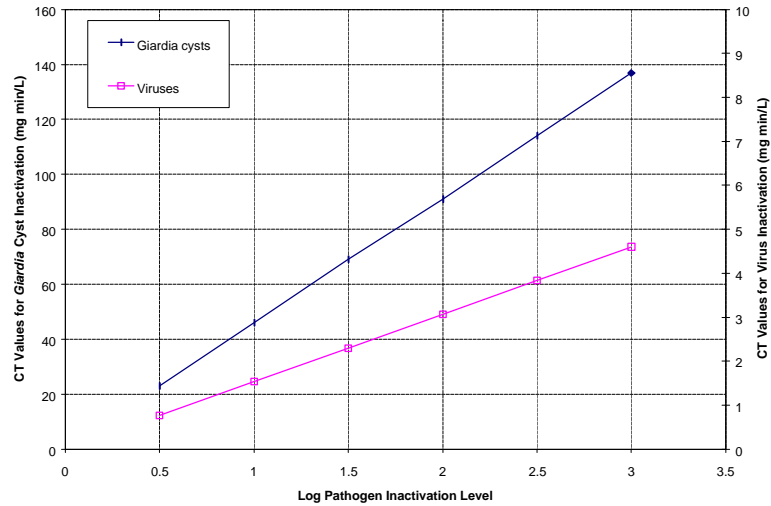
99.99 percent inactivation after 10 minutes (CT = 4 mg·min/L), six poliovirus strains reached 99.99 percent inactivation after 100 minutes (CT = 40 mg·min/L), and 11 of the 12 polioviruses plus one *Coxsackievirus* strain (12 out of a total of 20 viruses) reached 99.99 percent inactivation after 1,000 minutes (CT = 400 mg·min/L).

**Protozoa Inactivation.** Chlorine has been shown to have limited success inactivating protozoa. Data obtained during a 1984 study indicated that the resistance of *Giardia* cysts are two orders of magnitude higher than that of enteroviruses and more than three orders of magnitude higher than the enteric bacteria (Hoff et al., 1984). CT requirements for *Giardia* cysts inactivation when using chlorine as a disinfectant has been determined for various pH and temperature conditions (AWWA, 1991). These CT values increase at low temperatures and high pH (See also Table 2-13).

Chlorine has little impact on the viability of *Cryptosporidium* oocysts when used at the relatively low doses encountered in water treatment (e.g., 5 mg/L). Approximately 40 percent removals (0.2 log) of *Cryptosporidium* were achieved at CT values of both 30 and 3,600 mg·min/L (Finch et al., 1994). Another study determined that “no practical inactivation was observed” when oocysts were exposed to free chlorine concentrations ranging from 5 to 80 mg/L at pH 8, a temperature of 22°C, and contact times of 48 to 245 minutes (Gyürék et al., 1996). CT values ranging from 3,000 to 4,000 mg·min/L were required to achieve 1-log of *Cryptosporidium* inactivation at pH 6.0 and temperature of 22°C. During this study, one trial in which oocysts were exposed to 80 mg/L of free chlorine for 120 minutes was found to produce greater than 3-logs of inactivation.

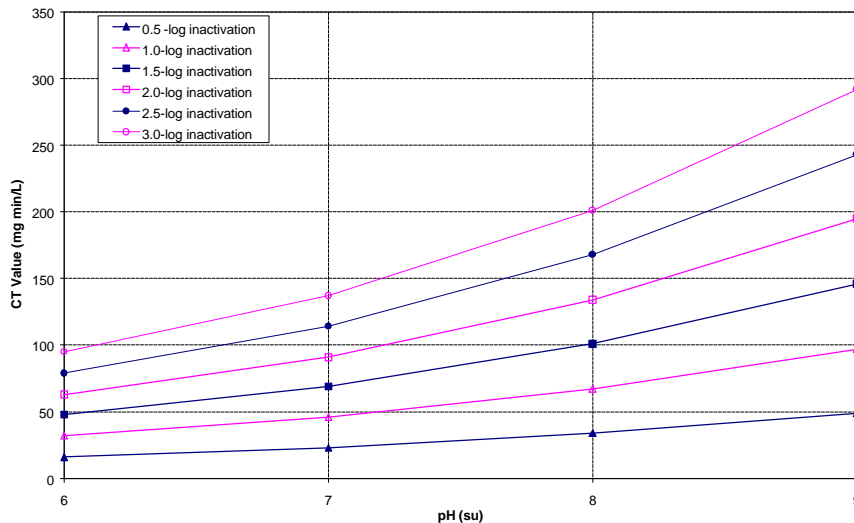
#### 2.7.4.4 CT Curves

Chlorine is regarded as a strong disinfectant that is effective at inactivating bacteria and viruses, and under certain circumstances, *Giardia*. Because of chlorine’s extremely high virus inactivation efficiency, CT values are almost always governed by protozoa inactivation. For example, Figure 2-1 shows the CT values required to achieve between 0.5 and 3-logs of virus and *Giardia* inactivation (AWWA, 1991). As shown, the CT values required to achieve the recommended disinfection efficiency for conventional filtration systems (i.e., 0.5-log *Giardia* cyst and 2-log virus inactivation level) are 23 and 3 mg min/L, respectively.

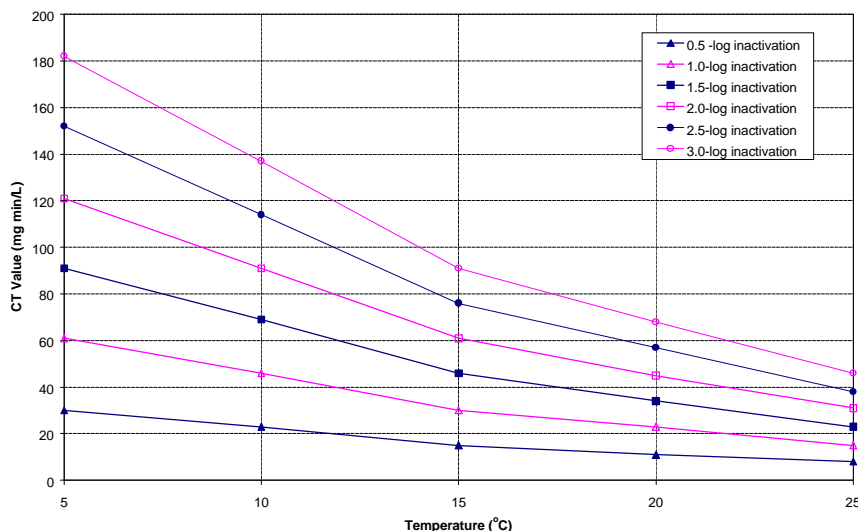


**Figure 2-1. Free Chlorine *Giardia* and Virus CT Requirements**

CT values for *Giardia* inactivation for various pH values and temperatures at a chlorine dose of 3.0 mg/L are shown in Figures 2-2 and 2-3. As shown, the inactivation efficacy of free chlorine decreases with increasing pH and/or decreasing temperature. CT values shown in Figures 2-2 and 2-3 are based on animal infectivity and excystation studies. CT values ranging from 0.5 to 3-log inactivation at temperatures of 0.5 and 5°C were based on a multiplicative model, and applying first order kinetics to the 99 percent upper confidence interval of the 99.99-percentile CT values. CT values for temperatures above 5°C were estimated by assuming a twofold decrease for every 10°C decrease in temperature.



**Figure 2-2. CT Values for Inactivation of *Giardia* Cysts by Free Chlorine at 10°C (at Cl<sub>2</sub> dose of 3.0 mg/L)**



**Figure 2-3. CT Values for Inactivation of *Giardia* Cysts by Free Chlorine at pH 7.0 (at Cl<sub>2</sub> dose of 3.0 mg/L)**

## 2.7.5 DBP Formation and Control

### 2.7.5.1 DBP Formation

Halogenated organics are formed when natural organic matter (NOM) reacts with free chlorine or free bromine. Free chlorine is normally introduced into water directly as a primary or secondary disinfectant. Free bromine results from the oxidation by chlorine of the bromide ion in the source water. Factors affecting the formation of these halogenated DBPs include type and concentration of NOM, chlorine form and dose, time, bromide ion concentration, pH, organic nitrogen concentration, and temperature. Organic nitrogen significantly influenced the formation of nitrogen containing DBPs, including haloacetonitriles, halopicrines, and cyanogen halides (Reckhow et al., 1990; Hoigné and Bader, 1988).

The formation of DBPs is strongly related to TOC at the point of disinfection. DBP formation also correlates with the amount of chlorine consumed (Singer et al., 1995). Stevens et al. (1989) found that higher TTHM formation occurs at high pH (9.4) than at low pH (5.0) while HAA showed no clear trend as a function of pH. A survey of 35 water utilities conducted by MWDSC (Krasner et al., 1989) showed the median TTHM and HAA concentrations measured as 39 and 19 µg/L (i.e. more THMs than HAAs are formed). However, a subsequent study by Singer et al. (1995) found a reversal in dominance, with more HAAs than THMs produced in waters from North Carolina utilities. They postulated that the reason for this change is due to the lower pH levels and differences in TOC and bromide concentrations in the North Carolina waters. Pourmoghaddas et al. (1993) showed that brominated and mixed brominated/chlorinated THMs and HAAs are formed when using chlorine in the presence of bromide.

The occurrence of THMs and HAAs is important because regulatory limits are placed on both groups of compounds. One water utility may therefore find that its chlorination practice is limited by the production of THMs, while another will find that HAAs limit the use of chlorine. This distribution of THMs and HAA is a function of the TOC and bromide concentration in the water, as well as the pH during chlorination.

Of note, Chlorate is produced as a byproduct when hypochlorite degrades during storage.

### 2.7.5.2 DBP Control

DBPs can be controlled by several means, including removing the DBP precursors, modifying the chlorination strategy, changing disinfectants, or removing the DBP itself. Because DBPs are difficult to remove once they are formed, control strategies typically focus on the first three methods.

Studies have shown that removal of TTHM precursors tends to remove the formation potential for the other DBPs. Generally, aggregate DBP formation will decrease as the removal of TOC increases. Recent research indicates that moving the point of chlorination back into the treatment process can reduce the formation of DBPs.

Summers et al. (1997) recently summarized the results from four studies evaluating the impact of pretreatment on DBP formation. Jar tests were conducted to simulate the water treatment through rapid mix, coagulation, flocculation, and sedimentation. Chlorine was added at various points in the jar testing to simulate the impact of various dose points on production of DBPs. The results clearly demonstrate the benefits of delaying the point of chlorination downstream in the treatment train to take advantage of precursor removal during initial flocculation and sedimentation processes. Table 2-21 summarizes the results from this study.

**Table 2-21. Percent Reduction in DBP Formation by Moving Chlorination Point Later In Treatment Train**

Chlorination point	TTHM Baseline (%)	TTHM Enhanced (%)	HAA5 Baseline (%)	HAA5 Enhanced (%)
Pre rapid mix	Basis	17	Basis	4.7
Post rapid mix	1.6	21	5.3	21
Mid flocculation	8.7	36	14	36
Post sedimentation	21	48	35	61

Notes: Source: USEPA, 1997b based on Summers et al., 1997.

Baseline = Baseline coagulant (alum) dose for optimal turbidity removal (~30 mg/L)

Enhanced = Enhanced coagulant (alum) dose for optimal TOC removal (~52 mg/L)

Table 2-21 also shows the benefit of enhanced coagulation to reduce DBP production. The THM reduction of 21 percent by moving the chlorination point to post sedimentation is more than doubled to 48 percent by enhanced coagulation. The HAA removal increases from 45 to 61 percent under

enhanced coagulation with post sedimentation chlorination. Therefore, DBP control by selecting the optimal dose location and conditions along with enhanced precursor removal can significantly reduce DBP formation at low added cost.

White (1992) suggested that pretreatment goals should include: 1) maximizing THM precursor removal; 2) reducing ammonia-N concentration to 0.10 mg/L; 3) reducing organic-N concentration to 0.05 mg/L; and 4) limiting 15-minute chlorine demand to 0.5 mg/L. These guidelines should improve raw water quality sufficiently to allow the use of the free chlorine residual process without exceeding the EPA MCLs for TTHMs.

## 2.7.6 Operational Considerations

### 2.7.6.1 Application Methods

Different application methods are used, depending upon the form of chlorine used. The following paragraphs describe the typical application methods for chlorine, sodium hypochlorite, and calcium hypochlorite.

**Chlorine.** Liquefied chlorine gas is typically evaporated to gaseous chlorine prior to metering. The heat required for evaporation can be provided through either a liquid chlorine evaporator or the ambient heat input to the storage container. Once the compressed liquid chlorine is evaporated, chlorine gas is typically fed under vacuum conditions. Either an injector or a vacuum induction mixer usually creates the required vacuum. The injector uses water flowing through a venturi to draw the chlorine gas into a side stream of carrier water to form a concentrated chlorine solution. This solution is then introduced into the process water through a diffuser or mixed with a mechanical mixer. A vacuum induction mixer uses the motive forces of the mixer to create a vacuum and draws the chlorine gas directly into the process water at the mixer.

**Sodium Hypochlorite.** Sodium hypochlorite solutions degrade over time. For example, a 12.5 percent hypochlorite solution will degrade to 10 percent in 30 days under “best case” conditions (White, 1992). Increased temperature, exposure to light, and contact with metals increase the rate of sodium hypochlorite degradation (Connell, 1996).

Sodium hypochlorite solution is typically fed directly into the process water using a type of metering pump. Similar to chlorine solution, sodium hypochlorite is mixed with the process water with either a mechanical mixer or induction mixer. Sodium hypochlorite solution is typically not diluted prior to mixing to reduce scaling problems.

**Calcium Hypochlorite.** Commercial high-level calcium hypochlorite contains at least 70% available chlorine (USEPA, 1991). Under normal storage conditions, calcium hypochlorite loses 3 to 5% of its available chlorine in a year (AWWA and ASCE, 1997). Calcium hypochlorite comes in powder, granular, and compressed tablet forms (USEPA, 1991). Typically, calcium hypochlorite solution is prepared by mixing powdered or granular calcium hypochlorite with a small flow. The highly chlorinated solution is then flow paced into drinking water flow.

### 2.7.6.2 Safety and Handling Considerations

**Chlorine.** Chlorine gas is a strong oxidizer. The U.S. Department of Transportation classifies chlorine as a poisonous gas (Connell, 1996). Fire codes typically regulate the storage and use of chlorine. In addition, facilities storing more than 2,500 pounds of chlorine are subject to the following two safety programs:

- Process Safety Management standards regulated by the Occupational Safety and Health Administration under 29 CFR 1910.
- The Risk Management Program Rule administered by EPA under Section 112(r) of the Clean Air Act.

All of these regulations (as well as local and state codes and regulations) must be considered during the design and operation of chlorination facilities at a water treatment plant.

**Sodium Hypochlorite.** Sodium hypochlorite solution is a corrosive liquid with an approximate pH of 12 (AWWA, 1990). Therefore, typical precautions for handling corrosive materials such as avoiding contact with metals, including stainless steel, should be used.

Sodium hypochlorite solutions may contain chlorate. Chlorate is formed during the both the manufacturing and storage of sodium hypochlorite (due to degradation of the product). Chlorate formation can be minimized by reducing the degradation of sodium hypochlorite (Gilbert et al., 1995) by limiting storage time, avoid high temperatures and reduce light exposure.

Spill containment must be provided for the sodium hypochlorite storage tanks. Typical spill containment structures include containment for the entire contents of the largest tank (plus freeboard for rainfall or fire sprinklers), no uncontrolled floor drains, and separate containment areas for each incompatible chemical.

**Calcium Hypochlorite.** Calcium hypochlorite is an oxidant and as such should be stored separately from organic materials that can be readily oxidized. It should also be stored away from sources of heat. Improperly stored calcium hypochlorite has caused spontaneous combustion fires (White, 1992).

## 2.8 Summary

### 2.8.1 Advantages and Disadvantages of Chlorine Use

The following list presents selected advantages and disadvantages of using chlorine as a disinfection method for drinking water (Masschelein, 1992; Process Applications, Inc., 1992). Because of the wide variation of system size, water quality, and dosages applied, some of these advantages and disadvantages may not apply to a particular system.

### **Advantages**

- Oxidizes soluble iron, manganese, and sulfides
- Enhances color removal
- Enhances taste and odor
- May enhance coagulation and filtration of particulate contaminants
- Is an effective biocide
- Is the easiest and least expensive disinfection method, regardless of system size
- Is the most widely used disinfection method, and therefore, the best known
- Is available as calcium and sodium hypochlorite. Use of these solutions is more advantageous for smaller systems than chlorine gas because they are easier to use, are safer, and need less equipment compared to chlorine gas
- Provides a residual.

### **Disadvantages**

- May cause a deterioration in coagulation/filtration of dissolved organic substances
- Forms halogen-substituted byproducts
- Finished water could have taste and odor problems, depending on the water quality and dosage
- Chlorine gas is a hazardous corrosive gas
- Special leak containment and scrubber facilities could be required for chlorine gas
- Typically, sodium and calcium hypochlorite are more expensive than chlorine gas
- Sodium hypochlorite degrades over time and with exposure to light
- Sodium hypochlorite is a corrosive chemical
- Calcium hypochlorite must be stored in a cool, dry place because of its reaction with moisture and heat
- A precipitate may form in a calcium hypochlorite solution because of impurities, therefore, an antiscalant chemical may be needed
- Higher concentrations of hypochlorite solutions are unstable and will produce chlorate as a byproduct
- Is less effective at high pH
- Forms oxygenated byproducts that are biodegradable and which can enhance subsequent biological growth if a chlorine residual is not maintained.

- Release of constituents bound in the distribution system (e.g., arsenic) by changing the redox state.

## 2.8.2 Summary Table

Table 2-22 presents a summary of the considerations for the use of chlorine as a disinfectant.

**Table 2-22. Summary of Chlorine Disinfection**

Consideration	Description
Generation	Chlorination may be performed using chlorine gas or other chlorinated compounds that may be in liquid or solid form. Chlorine gas can be generated by a number of processes including the electrolysis of alkaline brine or hydrochloric acid, the reaction between sodium chloride and nitric acid, or the oxidation of hydrochloric acid. Since chlorine is a stable compound, chlorine gas, sodium hypochlorite, and calcium hypochlorite are typically produced off-site by a chemical manufacturer.
Primary uses	The primary use of chlorination is disinfection. Chlorine also serves as an oxidizing agent for taste and odor control, prevention of algal growths, maintaining clear filter media, removal of iron and manganese, destruction of hydrogen sulfide, color removal, maintaining the water quality at the distribution systems, and improving coagulation.
Inactivation efficiency	The general order of increasing chlorine disinfection difficulty is bacteria, viruses, and then protozoa. Chlorine is an extremely effective disinfectant for inactivating bacteria and highly effective viricide. However, chlorine is less effective against <i>Giardia</i> cysts. <i>Cryptosporidium</i> oocysts are highly resistant to chlorine.
Byproduct formation	When added to the water, free chlorine reacts with NOM and bromide to form DBPs, primarily THMs, some haloacetic acids (HAAs), and others.
Point of application	Raw water storage, precoagulation/post-raw water storage, presedimentation/ postcoagulation, postsedimentation/prefiltration, post filtration (disinfection), or in the distribution system.
Special considerations	Because chlorine is such a strong oxidant and extremely corrosive, special storage and handling considerations should be considered in the planning of a water treatment plant. Additionally, health concerns associated with handling and use of chlorine is an important consideration.

## 2.8.3 Reference for Additional Information on Chlorine

With the focus of this manual on disinfectants other than chlorine, all of chlorine's uses and capabilities are not described here. For more detailed information regarding the use of chlorine in water treatment, refer to the list of references provided below. For complete references, see the References section at the end of this chapter.

- AWWA (1990)
- Connell (1996)
- DeMers and Renner (1992)
- Hazen and Sawyer (1992)
- Hoigné and Bader (1988)
- Sawyer et al. (1994)
- Singer (1988)
- White (1992)

## 2.9 References

1. AWWA (American Water Works Association). 1979. "Committee, Viruses in Drinking Water." *J. AWWA*. 71(8):441.
2. AWWA (American Water Works Association). 1990. *Water Quality and Treatment*. F.W. Pontius (editor). McGraw-Hill, New York, NY.
3. AWWA (American Water Works Association). 1991. *Guidance Manual for Compliance with the Filtration and Disinfection Requirements for Public Works Systems using Surface Water Sources*.
4. AWWA (American Water Works Association). 1995. *Problem Organisms in Water: Identification and Treatment*. AWWA, Denver, CO.
5. AWWA and ASCE (American Water Works Association and American Society of Civil Engineers). 1997. *Water Treatment Plant Design*. McGraw-Hill, New York, NY.
6. AWWARF (American Water Works Association Research Foundation) and Lyonnaise des Eaux. 1987. *Identification and Treatment of Tastes and Odors in Drinking Water*. American Water Works Association, Denver, CO.
7. Babcock, D.S. and P.C. Singer. 1979. "Chlorination and Coagulation of Humic and Fulvic Acids." *J. AWWA*. 71(3):149.
8. Beneson, A.S. 1981. "Control of Communicable Diseases in Man." APHA.
9. Belanger, S.E., D.S. Cherry, J.L. Farris, K.G. Sappington, and J. Cairns, Jr. 1991. "Sensitivity of the Asiatic Clam to Various Biocidal Control Agents." *J. AWWA*. 83(10):79-87.
10. Black, B.D., G.W. Harrington, and P.C. Singer. 1996. "Reducing Cancer Risks by Improving Organic Carbon Removal." *J. AWWA*. 88(6):40.

11. Brady, Thomas J., J.E. Van Benschoten, and J.N. Jensen. 1996. "Chlorination Effectiveness for Zebra and Quagga Mussels." *J. AWWA*. 88(1):107-110.
12. Britton, J.C. and B.A. Morton. 1982. "Dissection Guide, Field and Laboratory Manual for the Introduced Bivalve *Corbicula fluminea*." *Malacol. Rev.* 3(1).
13. Butterfield, C.T. et al. 1943, *Public Health Rep.* 58:1837.
14. Cameron, G.N., J.M. Symons, S.R. Spencer, and J.Y. Ma. 1989a. "Minimizing THM Formation During Control of the Asiatic Clam: A Comparison of Biocides." *J. AWWA*. 81(10):53-62.
15. Cameron, G.N., J.M. Symons, D. Bushek and R. Kulkarni. 1989b. "Effect of Temperature and pH on the Toxicity of Monochloramine to the Asiatic Clam." *J. AWWA*. 81(10):63-71.
16. CDC (Centers for Disease Control). 1989. "Assessing the Public Threat Associated with Waterborne Cryptosporidiosis: Report of a Workshop." *J. AWWA*. 80(2):88.
17. Chick, H. 1908. "Investigation of the Laws of Disinfection." *J. Hygiene*. 8:92.
18. Christman, R.F., et al. 1983. "Identity and Yields of Major Halogenated Products of Aquatic and Fulvic Acid Chlorination." *Environ. Sci. Technol.* 17(10):625.
19. Chlorine Institute. 1996. *Chlorine Institute Manual*. 6th Edition, The Chlorine Institute, Washington, D.C.
20. Clarke, N.A., et al. 1962. *Human Enteric Viruses in Water, Source, Survival, and Removability, International Conference on Water Pollution Research*. Landar.
21. Connell, G.F. 1996. *The Chlorination/Chloramination Handbook*. American Water Works Association. Denver, CO.
22. Counts, C.L. III. 1986. "The Zoogeography and History of the Invasion of the United States by *Corbicula fluminea* (Bivalvia: Corbiculidae)." *Amer. Malac. Bull.* 2(7), special edition.
23. Craun, G.F. and W. Jakubowski. 1996. "Status of Waterborne Giardiasis Outbreaks and Monitoring Methods." American Water Resources Association, Water Related Health Issue Symp., Atlanta, GA. November.
24. Craun, G.F. 1981. "Outbreaks of Waterborne Disease in the United States." *J. AWWA*. 73(7):360.
25. Culp, G.L., and R.L. Culp. 1974. *New Concepts in Water Purification*. Van Nostrand Reinhold Company, New York, NY.

26. Culp/Wesner/Culp. 1986. *Handbook of Public Water Systems*. Van Nostrand Reinhold, New York, NY.
27. DeMers, L.D. and R.C. Renner, R.C. 1992. "Alternative Disinfection Technologies for Small Drinking Water Systems." AWWA and AWWARF, Denver, CO.
28. Duguet, J.P., Y. Tsutsumi, A. Bruchet, and Mallevalle. 1985. "Chloropicrin in Potable Water: Conditions of Formation and Production during Treatment Processes." *Water Chlorination: Chemistry, Environmental Impact and Health Effects*, Volume 5. Lewis Publishers.
29. Evans, L.P., Jr., et al. 1979. Salinity Relationships in *Corbicula fluminea*; *Miller (1774)*. Conference proceedings, first International Corbicula Symposium. J.C. Britton (editor). Texas Christian Univ., Ft. Worth, TX.
30. Farvardin, M.R. and A.G. Collins. 1990. Mechanism(s) of Ozone-Induced Coagulation of Organic Colloids. Conference Proceedings, AWWA Annual Conference, Cincinnati, OH. June 17-21.
31. Ferguson, D.W., J.T. Gramith, and M.J. McGuire. 1991. "Applying Ozone for Organics Control and Disinfection: A Utility Perspective." *J. AWWA*. 83(5):32-39.
32. Ferguson, D.W., M.J. McGuire, B. Koch, R.L. Wolfe, and E.M. Aieta. 1990. "Comparing PEROXONE and Ozone for Controlling Taste and Odor Compounds, Disinfection Byproducts, and Microorganisms." *J. AWWA*. 82(4):181-191.
33. Finch, G.R., E.K. Black, and L.L. Gyürék. 1994. Ozone and Chlorine Inactivation of *Cryptosporidium*. Conference proceedings, Water Quality Technology Conference, Part II. San Francisco, CA.
34. Geldreich, E.E. 1972. *Water Pollution Microbiology*. R. Mitchell (editor). John Wiley & Sons, New York, NY.
35. Gordon, G., L. Adam, and B. Bubnis. 1995. *Minimizing Chlorate Ion Formation in Drinking Water when Hypochlorite Ion is the Chlorinating Agent*. AWWA-AWWARF, Denver, CO.
36. Gurol, M.D. and M. Pidotella. 1983. A Study of Ozone-Induced Coagulation. Conference proceedings, ASCE Environmental Engineering Division Specialty Conference. Allen Medine and Michael Anderson (editors). Boulder, CO.
37. Gyürék, L.L., L.R.J. Liyanage, M. Belosevic, and G.R. Finch. 1996. "Disinfection of *Cryptosporidium Parvum* Using Single and Sequential Application of Ozone and Chlorine Species." Conference proceedings, AWWA Water Quality Technology Conference, Boston, MA.

38. Haas C.N. and R.S. Engelbrecht. 1980. "Physiological Alterations of Vegetative Microorganisms Resulting from Aqueous Chlorination." *J. Water Pollution Control Fed.* 52(7):1976.
39. Hazen and Sawyer. 1992. *Disinfection Alternatives for Safe Drinking Water*. Van Nostrand Reinhold, New York, NY.
40. Herbert, P.D.N., B.W. Muncaster II, and G.L. Mackie. 1989. "Ecological and Genetic Studies on *Dreissena polymorpha* (Pallas): A New Mollusc in the Great Lakes." *Can. Jour. Fisheries and Aquatic Sci.* 46:1587.
41. Hildebrand, D.J., A.F. Hess, P.B. Galant, and C.R. O'Melia. 1986. "Impact of Chlorine Dioxide and Ozone Preoxidation on Conventional Treatment and Direct Filtration Treatment Processes." Conference proceedings, AWWA Annual Conference, Denver, CO.
42. Hoff, J.C., E.W. Rice, and F.W. Schaefer. 1984. "Disinfection and the Control of Waterborne Giardiasis." Conference proceedings, ASCE Specialty Conference.
43. Hoigné J., and H. Bader. 1988. "The Formation of Trichloronitromethane (chloropicrin) and Chloroform in a Combined Ozonation/Chlorination Treatment of Drinking Water." *Water Resources.* 22 (3):313.
44. Huck, P.M., W.B. Anderson, C.L. Lang, W.A. Anderson, J.C. Fraser, S.Y. Jasim, S.A. Andrews, and G. Pereira. 1995. "Ozone vs. PEROXONE for Geosmin and 2-Methylisoborneol Control: Laboratory, Pilot and Modeling Studies." Conference proceedings, AWWA Annual Conference, Anaheim, CA.
45. IOA. 1997. IOA Survey of Water Treatment Plants. International Ozone Association, Stanford, CT.
46. Karimi, A.A. and P.C. Singer. 1991. Trihalomethane Formation in Open Reservoirs. *J. AWWA.* 83 (3):84.
47. Klerks, P.L. and P.C. Fraleigh, P.C. 1991. "Controlling Adult Zebra Mussels with Oxidants." *J. AWWA.* 83 (12):92-100.
48. Koch, B., S.W. Krasner, M.J. Scimienti, and W.K. Schimpff. 1991. "Predicting the Formation of DBPs by the Simulated Distribution System." *J. AWWA.* 83(10):62-70.
49. Kramer, M.H., B.L. Herwaldt, G.F. Craun, R.L. Calderon, and D.D. Juranek. 1996. "Waterborne Disease: 1993 and 1994." *J. AWWA.* 88(3):66-80.
50. Krasner, S.W., M.J. McGuire, J.G. Jacangelo. 1989. "The Occurrence of Disinfection Byproducts in US Drinking Water." *J. AWWA.* 81(8):41-53.

51. Lâiné, J.M., J.G. Jacangelo, E.W. Cummings, K.E. Carns, J. Mallevalle. 1993. "Influence of Bromide on Low-Pressure Membrane Filtration for Controlling DBPs in Surface Waters." *J. AWWA*. 85(6):87-99.
52. Lalezary, S., M. Pirbazari, and M.J. McGuire. 1986. "Oxidation of Five Earthy-Musty Taste and Odor Compounds." *J. AWWA*. 78(3):62.
53. Lang, C.L. 1994. "The Impact of the Freshwater Macrofouling Zebra Mussel (*Dreissena Polymorpha*) on Drinking Water Suppliers." Conference proceedings, AWWA Water Quality Technology Conference Part II, San Francisco, CA.
54. Langlais, B., D.A. Reckhow, and D.R. Brink. (editors). 1991. *Ozone in Drinking Water Treatment: Application and Engineering*. AWWARF and Lewis Publishing, Chelsea, MI.
55. Liu, O.C., et al. 1971. "Relative Resistance of Twenty Human Enteric Viruses to Free Chlorine. Virus and Water Quality: Occurrence and Control." Conference Proceedings, thirteenth Water Quality Conference, University of Illinois, Urbana-Champaign.
56. MacKenzie, W.R., et al. 1994. "A Massive Outbreak in Milwaukee of *Cryptosporidium* Infection Transmitted Through the Public Water Supply." *New England J. of Medicine*. 331(3):161.
57. Masschelein, W.J. 1992. "Unit Processes in Drinking Water Treatment." Marcel Decker D.C., New York, Brussels, Hong Kong.
58. Matisoff, G., G. Brooks, and B.I. Bourland. 1996. "Toxicity of Chlorine Dioxide to Adult Zebra Mussels." *J. AWWA*. 88 (8):93-106.
59. McGuire, M.J., and R.G. Meadow. 1989. "AWWARF Trihalomethane Survey." *J. AWWA*. 80(1):61.
60. Montgomery J. M. 1985. *Water Treatment Principles and Design*. John Wiley & Sons, New York, NY.
61. Nieminski, E.C., S. Chaudhuri, and T. Lamoreaux. 1993. "The Occurrence of DBPs in Utah Drinking Waters." *J. AWWA*. 85(9):98-105.
62. Oliver, B.G., and D.B. Shindler. 1980. "Trihalomethanes From Chlorination of Aquatic Algae." *Env. Sci. Tech.* 14(12):1502.
63. Olson, K.E. 1982. An Evaluation of Low Chlorine Concentrations on *Giardia* Cyst Viability, USDA Forest Service, Equipment Development Center, San Dimas, CA. January.

64. Pourmoghaddas, H., A.A. Stevens, R.N. Kinman, R.C. Dressman, L.A. Moore, J.C. Ireland. 1993. "Effect of Bromide Ion on Formation of HAAs During Chlorination." *J. AWWA*. 85(1):82-87.
65. Prendiville, P.W. 1986. "Ozonation at the 900 cfs Los Angeles Water Purification Plant." *Ozone: Sci. Engrg.* 8:77.
66. Reckhow D.A., W.R. Knocke, M.J. Kearney, C.A. Parks. 1991. "Oxidation of Iron and Manganese by Ozonation." *Environ. Sci. and Engrg.* 13(6):675-695.
67. Reckhow D.A., P.C. Singer, and R.L. Malcolm. 1990. "Chlorination of Humic Materials: Byproduct Formation and Chemical Interpretations." *Environ. Sci. Technol.* 24(11):1655.
68. Reckhow, D.A., and P.C. Singer. 1985. "Mechanisms of Organic Halide Formation During Fulvic Acid Chlorination and Implications with Respect to Preozonation." *Water Chlorination: Chemistry, Environmental Impact and Health Effects*, Volume 5. Jolley, R.L. et al. (editors). Lewis Publishers, Chelsea, MI.
69. Reckhow, D.A., J.K. Edzwald, and J.E. Tobiason. 1993. *Ozone as an Aid to Coagulation and Filtration*. AWWARF, AWWA, Denver, CO.
70. Reckhow, D.A., P.C. Singer, and R.R. Trussell. 1986. Ozone as a coagulant aid. Seminar proceedings, Ozonation, Recent Advances and Research Needs, AWWA Annual Conference, Denver, CO.
71. Rice, R.G., Overbeck, P.K., Larson, K. 1998. Ozone Treatment for Small Water Systems. Presented at First International Symposium on Safe Drinking Water in Small Systems, NSF International/PAHP/WHO, Arlington, VA. (In press)
72. Riggs, J.L. 1989. "Aids Transmission in Drinking Water: No Threat." *J. AWWA*. 81(9):69.
73. Roberts, R. 1990. "Zebra Mussel Invasion Threatens US Waters." *Science*. 249:1370.
74. Salvato, J.A., Jr. 1972. *Environmental Engineering and Sanitation*. second edition, John Wiley & Sons, New York, NY.
75. Sawyer, C.N., P.L. McCarty, L. Parkin, and G.F. Parkin. 1994. *Chemistry for Environmental Engineering*. McGraw Hill, Inc., New York, NY.
76. Scarpino P.V., et al. 1972. "A Comparative Study of the Inactivation of Viruses in Water by Chlorine." *Water Research*. 6:959.
77. Sinclair, R.M. 1964. "Clam Pests in Tennessee Water Supplies." *J. AWWA*. 56 (5):592.

78. Singer, P.C. 1988. *Alternative Oxidant and Disinfectant Treatment Strategies for Controlling THM Formation*. EPA 600/S2-88/044. October.
79. Singer P.C. 1992. "Formation and Characterization of Disinfection Byproducts." Presented at the First International Conference on the Safety of Water Disinfection: Balancing Chemical and Microbial Risks.
80. Singer P.C. 1993. "Trihalomethanes and Other Byproducts Formed From the Chlorination of Drinking Water." National Academy of Engineering Symposium on Environmental Regulation: Accommodating Changes in Scientific, Technical, or Economic Information. Washington, D.C.
81. Singer P.C., and S.D. Chang. 1989. "Correlations Between Trihalomethanes and Total Organic Halides Formed During Water Treatment." *J. AWWA*. 81(8):61-65.
82. Singer P.C., and G.W. Harrington. 1993. "Coagulation of DBP Precursors: Theoretical and Practical Considerations." Conference proceedings, AWWA Water Quality Technology Conference, Miami, FL.
83. Smith, A.L. et al. 1979. "Clams--A growing Threat to Implant Water Systems." *Plant Engrg.* 33:165.
84. Snead, M.C., et al. 1980. *Benefits of Maintaining a Chlorine Residual in Water Supply Systems*. EPA 600/2-80-010.
85. Stevens, A.A., et al. 1976. "Chlorination of Organics in Drinking Water." *J. AWWA*. 8(11):615.
86. Stevens, A.A., L.A. Moore, R.J. Miltner. 1989. "Formation and Control of Non-Trihalomethane Disinfection By-products." *J. AWWA*. 81(8):54-60.
87. Suffet, I. H., C. Anselme, and J. Mallevalle. 1986. "Removal of Tastes and Odors by Ozonation." Conference proceedings, AWWA Seminar on Ozonation: Recent Advances and Research Needs, Denver, CO.
88. Summers, R.S., G. Solarik, V.A. Hatcher, R.S. Isabel, J.F. Stile. 1997. "Analyzing the Impacts of Predisinfection Through Jar Testing." Conference proceedings, AWWA Water Quality Technology Conference, Denver, CO.
89. Taylor, F.B. 1974. "Viruses - What is Their Significance in Water Supplies." *J. AWWA*. 66:306.
90. Thibaud, H., H. DeLaat, N. Merlet, and M. Doré. 1987. "Chloropicrin Formation in Aqueous Solution: Effect of Nitrites on Precursors Formation During the Oxidation of Organic Compounds." *Water Res.* 21(7):813.

91. Thibaud, H., J. DeLaat, and M. Doré. 1988. "Effects of Bromide Concentration on the Production of Chloropicrin During Chlorination of Surface Waters: Formation of Brominated Trihalonitromethanes." *Water Res.* 22(3):381.
92. Tobiason, J.E., J.K. Edzwald, O.D. Schneider, M.B. Fox, and H.J. Dunn. 1992. "Pilot Study of the Effects of Ozone and PEROXONE on In-Line Direct Filtration." *J. AWWA.* 84(12):72-84.
93. USEPA. 1998a. *Occurrence Assessment for Disinfectants and Disinfection Byproducts in Public Drinking Water Supplies.* Science Applications International Corporation under contract for Office of Ground Water and Drinking Water. Washington, DC.
94. USEPA. 1998b. *Technologies and Costs for Control of Disinfection Byproducts.* Prepared by Malcolm Pirnie, Inc for U.S. Environmental Protection Agency, Office of Ground Water and Drinking Water, PB93-162998.
95. USEPA. 1997a. *Community Water System Survey - Volumes I and II; Overview.* EPA 815-R-97-001a, -001b. January.
96. USEPA. 1997b. "National Primary Drinking Water Regulations: Disinfectants and Disinfection Byproducts; Notice of Data Availability; Proposed Rule." *Federal Register.* 62(212):59387-59484. November 3.
97. USEPA. 1996. *Drinking Water Regulations and Health Advisories.* EPA 822-B-96-002, October.
98. USEPA. 1991. *Manual of Individual and Non-Public Works Supply Systems.* Office of Water, EPA 570/9-91-004.
99. Van Benschoten, J.E., J.N. Jensen, D. Harrington, and D.J. DeGirolamo. 1995. "Zebra Mussel Mortality With Chlorine." *J. AWWA.* 87(5):101-108.
100. Wachter, J.K., and J.B. Andelman. 1984. "Organohalide Formation on Chlorination of Algal Extracellular Products." *Env. Sci. Technol.* 18(111):811.
101. Watson, H.E. 1908. "A Note on the Variation of the Rate of Disinfection With Change in the Concentration of the Disinfectant." *J. Hygiene.* 8:538.
102. White, G.C. 1992. *Handbook of Chlorination and Alternative Disinfectants.* Van Nostrand Reinhold, New York, NY.
103. Witherell, L.E, R.W. Duncan, K.M. Stone, L.J. Stratton, L. Orciari, S. Kappel, D.A. Jillson. 1988. "Investigation of Legionella Pneumophila in Drinking Water." *J. AWWA.* 80 (2):88-93.

<b>DISINFECTANT USE IN WATER TREATMENT .....</b>	<b>2-1</b>
2.1 NEED FOR DISINFECTION IN WATER TREATMENT.....	2-1
2.1.1 Pathogens of Primary Concern.....	2-2
2.1.2 Recent Waterborne Outbreaks .....	2-8
2.1.3 Mechanism of Pathogen Inactivation .....	2-9
2.2 OTHER USES OF DISINFECTANTS IN WATER TREATMENT .....	2-10
2.2.1 Minimization of DBP Formation.....	2-10
2.2.2 Control of Nuisance Asiatic Clams and Zebra Mussels.....	2-11
2.2.3 Oxidation of Iron and Manganese .....	2-13
2.2.4 Prevention of Regrowth in the Distribution System and Maintenance of Biological Stability.....	2-14
2.2.5 Removal of Taste and Odors Through Chemical Oxidation .....	2-15
2.2.6 Improvement of Coagulation and Filtration Efficiency .....	2-15
2.2.7 Prevention of Algal Growth in Sedimentation Basins and Filters .....	2-16
2.2.8 Removal of Color .....	2-16
2.3 DISINFECTION BYPRODUCTS AND DISINFECTION RESIDUALS .....	2-16
2.3.1 Types of DBPs and Disinfection Residuals .....	2-16
2.3.2 Disinfection Byproduct Formation .....	2-19
2.3.3 DBP Control Strategies.....	2-23
2.3.4 CT Factor .....	2-25
2.4 PATHOGEN INACTIVATION VERSUS DBP FORMATION .....	2-26
2.5 DISINFECTANT RESIDUAL REGULATORY REQUIREMENTS .....	2-27
2.6 SUMMARY OF CURRENT NATIONAL DISINFECTION PRACTICES .....	2-28
2.7 CHLORINE .....	2-30
2.7.1 Chlorine Chemistry .....	2-31
2.7.2 Chlorine Generation .....	2-32
2.7.3 Primary Uses and Points of Application of Chlorine.....	2-33
2.7.4 Pathogen Inactivation and Disinfection Efficacy.....	2-35
2.7.5 DBP Formation and Control .....	2-39
2.7.6 Operational Considerations.....	2-41
2.8 SUMMARY .....	2-42
2.8.1 Advantages and Disadvantages of Chlorine Use.....	2-42
2.8.2 Summary Table .....	2-44
2.8.3 Reference for Additional Information on Chlorine .....	2-44
2.9 REFERENCES .....	2-45

Table 2-1. Waterborne Diseases from Bacteria.....	2-3
Table 2-2. Waterborne Diseases from Human Enteric Viruses.....	2-4
Table 2-3. Waterborne Diseases from Parasites.....	2-6
Table 2-4. Attributes of the Three Waterborne Pathogens of Concern in Water Treatment.....	2-7
Table 2-5. Human Parasitic Protozoans.....	2-7
Table 2-6. The Effects of Various Oxidants on Mortality of the Asiatic Clam ( <i>Corbicula fluminea</i> ).....	2-12
Table 2-7. Oxidant Doses Required for Oxidation of Iron and Manganese.....	2-14
Table 2-8. List of Disinfection Byproducts and Disinfection Residuals.....	2-17
Table 2-9. Status of Health Information for Disinfectants and DBPs.....	2-18
Table 2-10. Conditions of Formation of DBPs .....	2-22
Table 2-11. Inorganic DBPs Produced During Disinfection.....	2-23
Table 2-12. Required Removal of TOC by Enhanced Coagulation for Surface Water Systems <sup>+</sup> Using Conventional Treatment <sup>++</sup> (percent reduction).....	2-25
Table 2-13. CT Values for Inactivation of Viruses .....	2-26
Table 2-14. CT Values for Inactivation of <i>Giardia</i> Cysts.....	2-26
Table 2-15. Summary of Disinfection Impacts .....	2-27

Table 2-16. Disinfection Practices of Water Systems that Include Some Form of Treatment. 2-29

Table 2-17. Ozone Application in Water Treatment Plants in the United States ..... 2-30

Table 2-18. Chlorine Uses and Doses..... 2-34

Table 2-19. Typical Chlorine Points of Application and Uses ..... 2-34

Table 2-20. Typical Chlorine Dosages at Water Treatment Plants..... 2-35

Table 2-21. Percent Reduction in DBP Formation by Moving Chlorination Point Later In Treatment Train ..... 2-40

Table 2-22. Summary of Chlorine Disinfection ..... 2-44

Figure 2-1. Free Chlorine *Giardia* and Virus CT Requirements ..... 2-38

Figure 2-2. CT Values for Inactivation of *Giardia* Cysts by Free Chlorine at 10°C (at Cl<sub>2</sub> dose of 3.0 mg/L)..... 2-38

Figure 2-3. CT Values for Inactivation of *Giardia* Cysts by Free Chlorine at pH 7.0 (at Cl<sub>2</sub> dose of 3.0 mg/L)... 2-39

## 3. OZONE

---

Ozone was first used for drinking water treatment in 1893 in the Netherlands. While being used frequently in Europe for drinking water disinfection and oxidation, it was slow to transfer to the United States. In 1987, the Los Angeles Aqueduct Filtration Plant was placed in service and now treats up to 600 mgd of drinking water. In 1991, approximately 40 water treatment plants each serving more than 10,000 people in the United States utilized ozone (Langlais et al., 1991). This number has grown significantly, with Rice (in press) reporting that as of April 1998, 264 operating plants in the United States use ozone. Most of these facilities are small: 149 plants are below 1 mgd.

Ozone is used in water treatment for disinfection and oxidation. Early application of ozone in the United States was primarily for non-disinfection purposes such as color removal or taste and odor control. However, since the implementation of the SWTR and proposal of the DBP rule, ozone usage for primary disinfection has increased in the United States.

### 3.1 Ozone Chemistry

Ozone exists as a gas at room temperature. The gas is colorless with a pungent odor readily detectable at concentrations as low as 0.02 to 0.05 ppm (by volume), which is below concentrations of health concern. Ozone gas is highly corrosive and toxic.

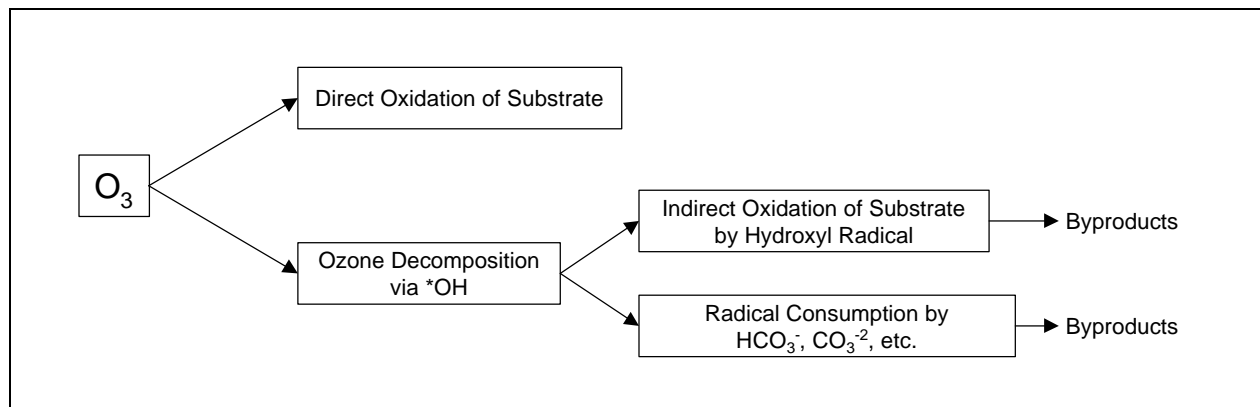
Ozone is a powerful oxidant, second only to the hydroxyl free radical, among chemicals typically used in water treatment. Therefore, it is capable of oxidizing many organic and inorganic compounds in water. These reactions with organic and inorganic compounds cause an ozone demand in the water treated, which should be satisfied during water ozonation prior to developing a measurable residual.

Ozone is sparingly soluble in water. At 20°C, the solubility of 100 percent ozone is only 570 mg/L (Kinman, 1975). While ozone is more soluble than oxygen, chlorine is 12 times more soluble than ozone. Ozone concentrations used in water treatment are typically below 14 percent, which limits the mass transfer driving force of gaseous ozone into the water. Consequently, typical concentrations of ozone found during water treatment range from <0.1 to 1mg/L, although higher concentrations can be attained under optimum conditions.

Basic chemistry research (Hoigné and Bader, 1983a and 1983b; Glaze et al., 1987) has shown that ozone decomposes spontaneously during water treatment by a complex mechanism that involves the generation of hydroxyl free radicals. The hydroxyl free radicals are among the most reactive oxidizing agents in water, with reaction rates on the order of  $10^{10}$  -  $10^{13}$   $M^{-1} s^{-1}$ , approaching the diffusion control rates for solutes such as aromatic hydrocarbons, unsaturated compounds, aliphatic alcohols, and formic acid (Hoigné and Bader, 1976). On the other hand, the half-life of hydroxyl free radicals is on the order of microseconds, therefore concentrations of hydroxyl free radicals can never reach levels above  $10^{-12}$  M (Glaze and Kang, 1988).

As shown in Figure 3-1 ozone can react by either or both modes in aqueous solution (Hoigné and Bader, 1977):

- Direct oxidation of compounds by molecular ozone ( $O_{3(aq)}$ ).
- Oxidation of compounds by hydroxyl free radicals produced during the decomposition of ozone.



**Figure 3-1. Oxidation Reactions of Compounds (Substrate) During Ozonation of Water**

The two oxidation pathways compete for substrate (i.e., compounds to oxidize). The direct oxidation with aqueous ozone is relatively slow (compared to hydroxyl free radical oxidation) but the concentration of aqueous ozone is relatively high. On the other hand, the hydroxyl radical reaction is fast, but the concentration of hydroxyl radicals under normal ozonation conditions is relatively small. Hoigné and Bader (1977) found that:

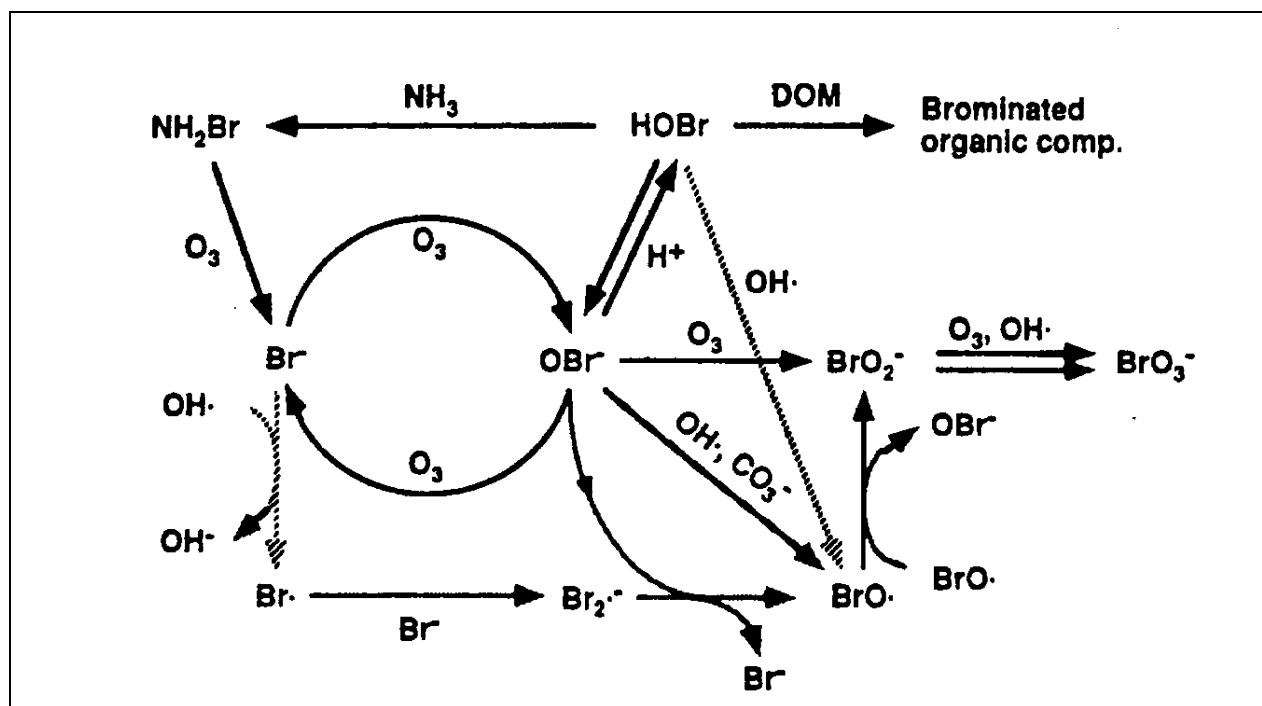
- Under acidic conditions, the direct oxidation with molecular ozone is of primary importance; and
- Under conditions favoring hydroxyl free radical production, such as high pH, exposure to UV, or addition of hydrogen peroxide, the hydroxyl oxidation starts to dominate.

This latter mechanism is used in advanced oxidation processes such as discussed in Chapter 7, Peroxone, to increase the oxidation rates of substrates.

The spontaneous decomposition of ozone occurs through a series of steps. The exact mechanism and reactions associated have not been established, but mechanistic models have been proposed (Hoigné and Bader, 1983a and 1983b; Glaze, 1987). It is believed that hydroxyl radicals form as one of the intermediate products, and can react directly with compounds in the water. The decomposition of ozone in pure water proceeds with hydroxyl free radicals produced as an intermediate product of ozone decomposition, resulting in the net production of 1.5 mole hydroxyl free radicals per mole ozone.

In the presence of many compounds commonly encountered in water treatment, ozone decomposition forms hydroxyl free radicals. Ozone demands are associated with the following:

- Reactions with natural organic matter (NOM) in the water. The oxidation of NOM leads to the formation of aldehydes, organic acids, and aldo- and ketoacids (Singer, 1992).
- Organic oxidation byproducts. Organic oxidation byproducts are generally more amenable to biological degradation and can be measured as assimilable organic carbon (AOC) or biodegradable dissolved organic carbon (BDOC).
- Synthetic organic compounds (SOCs). Some SOC's can be oxidized and mineralized under favorable conditions. To achieve total mineralization, hydroxyl radical oxidation should usually be the dominant pathway, such as achieved in advanced oxidation processes.
- Oxidation of bromide ion. Oxidation of bromide ion leads to the formation of hypobromous acid, hypobromite ion, bromate ion, brominated organics, and bromamines (see Figure 3-2).
- Bicarbonate or carbonate ions, commonly measured as alkalinity, will scavenge the hydroxyl radicals and form carbonate radicals (Stahelin et al., 1984; Glaze and Kang, 1988). These reactions are of importance for advanced oxidation processes where the radical oxidation pathway is predominant.



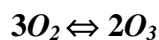
Source: Gunten and Hoigné, 1996.

**Figure 3-2. Reaction of Ozone and Bromide Ion Can Produce Bromate Ion and Brominated Organics**

## 3.2 Ozone Generation

### 3.2.1 Ozone Production

Because ozone is an unstable molecule, it should be generated at the point of application for use in water treatment. It is generally formed by, combining an oxygen atom with an oxygen molecule ( $O_2$ ):



This reaction is endothermic and requires a considerable input of energy.

Schönbein (Langlais et < biblio >) first discovered synthetic ozone through the electrolysis of sulfuric acid. Ozone can be produced several ways, although one method, corona discharge, predominates in the ozone generation industry. Ozone can also be produced by irradiating an oxygen-containing gas with ultraviolet light, electrolytic reaction and other emerging technologies as described by Rice (1996).

Corona discharge, also known as silent electrical discharge, consists of passing an oxygen-containing gas through two electrodes separated by a dielectric and a discharge gap. Voltage is applied to the electrodes, causing an electron flow through across the discharge gap. These electrons provide the energy to disassociate the oxygen molecules, leading to the formation of ozone. Figure 3-3 shows a basic ozone generator.

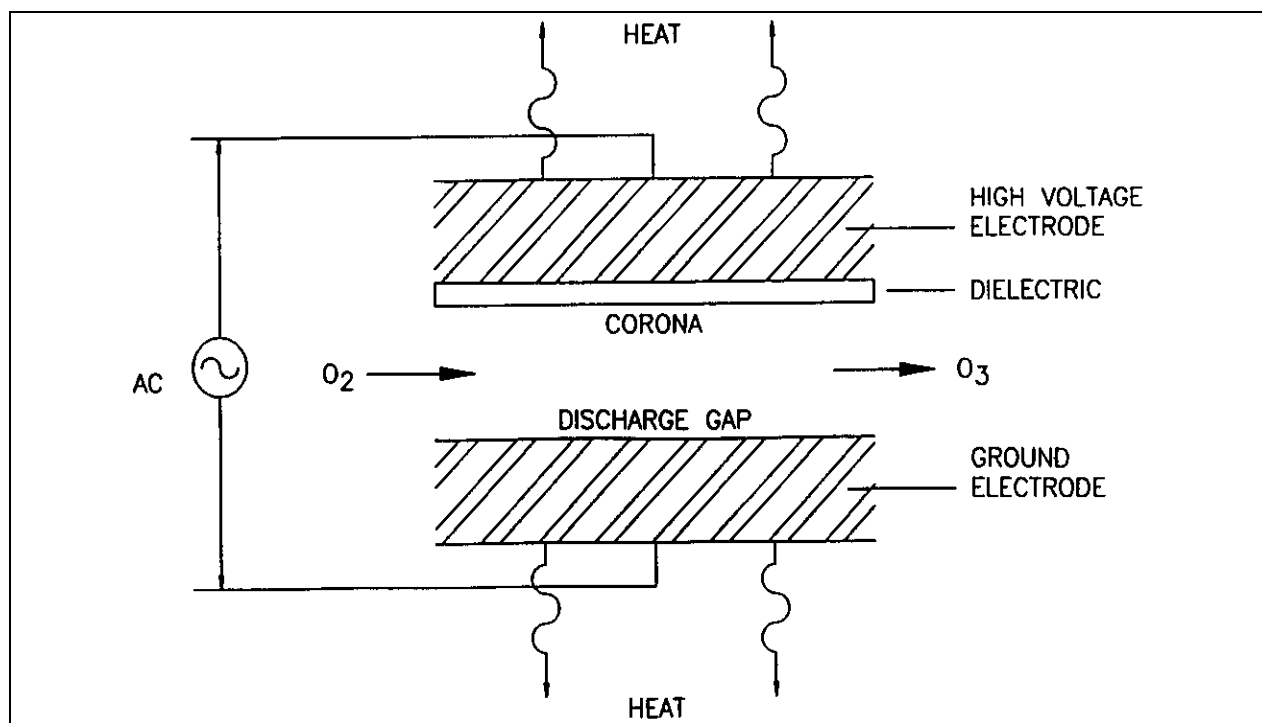


Figure 3-3. Basic Ozone Generator

### 3.2.2 System Components

As shown in Figure 3-4, ozone water treatment systems have four basic components: a gas feed system, an ozone generator, an ozone contactor, and an off-gas destruction system. The gas feed system provides a clean, dry source of oxygen to the generator. The ozone contactor transfers the ozone-rich gas into the water to be treated, and provides contact time for disinfection (or other reactions). The final process step, off-gas destruction, is required as ozone is toxic in the concentrations present in the off-gas. Some plants include an off-gas recycle system that returns the ozone-rich off-gas to the first contact chamber to reduce the ozone demand in the subsequent chambers. Some systems also include a quench chamber to remove ozone residual in solution.

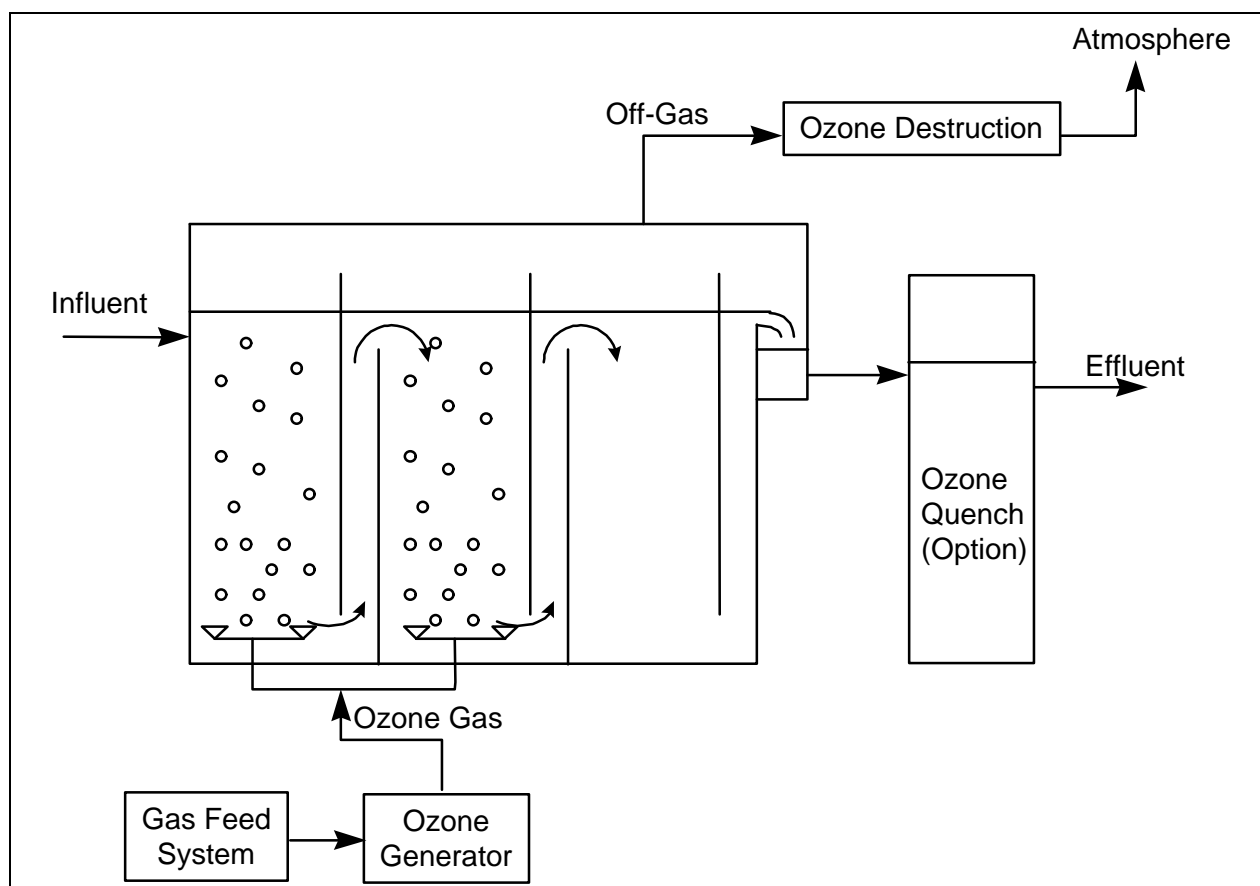


Figure 3-4. Simplified Ozone System Schematic

#### 3.2.2.1 Gas Feed Systems

Ozone feed systems are classified as using air, high purity oxygen or mixture of the two. High purity oxygen can be purchased and stored as a liquid (LOX), or it can be generated on-site through either a cryogenic process, with vacuum swing adsorption (VSA), or with pressure swing adsorption (PSA). Cryogenic generation of oxygen is a complicated process and is feasible only in large systems. Pressure swing adsorption is a process whereby a special molecular sieve is used under pressure to

selectively remove nitrogen, carbon dioxide, water vapor, and hydrocarbons from air, producing an oxygen rich (80–95 percent O<sub>2</sub>) feed gas. The components used in pressure swing adsorption systems are similar to high pressure air feed systems in that both use pressure swing molecular absorption equipment. Low pressure air feed systems use a heat reactivated desiccant dryer.

**Oxygen Feed Systems** - Liquid oxygen feed systems are relatively simple, consisting of a storage tank or tanks, evaporators to convert the liquid to a gas, filters to remove impurities, and pressure regulators to limit the gas pressure to the ozone generators.

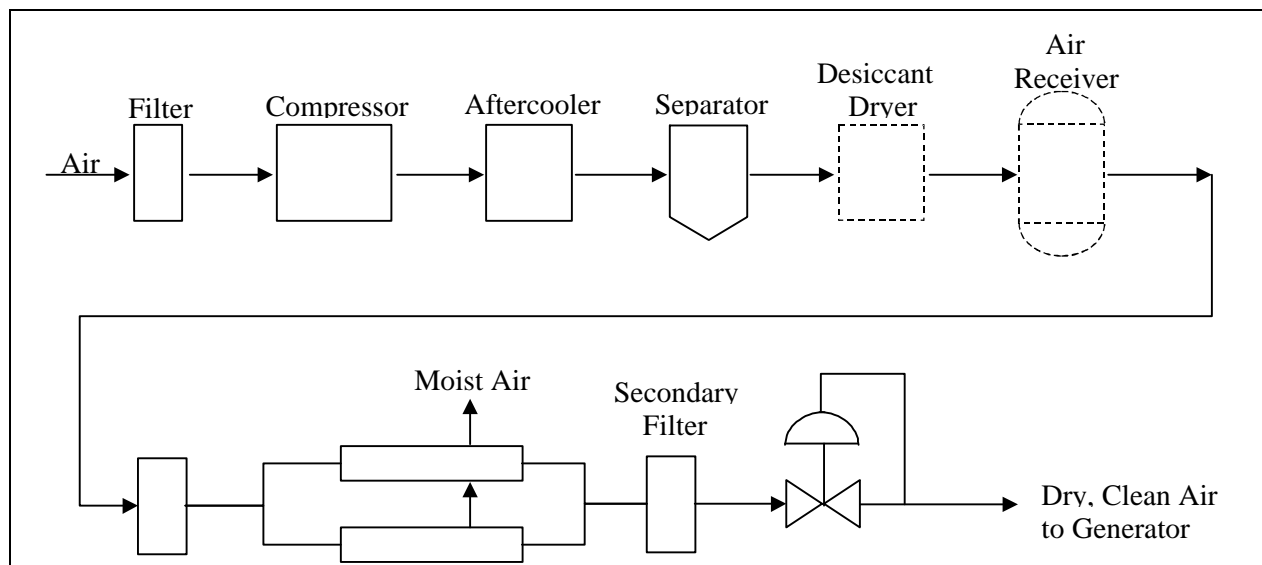
**Air Feed Systems** - Air feed systems for ozone generators are fairly complicated as the air should be properly conditioned to prevent damage to the generator. Air should be clean and dry, with a maximum dew point of -60° C (-80° F) and free of contaminants. Air preparation systems typically consist of air compressors, filters, dryers, and pressure regulators. Figure 3-5 is a schematic of large scale air preparation system.

Particles greater than 1 µm and oil droplets greater than 0.05 µm should be removed by filtration (Langlais et al., 1991). If hydrocarbons are present in the feed gas, granular activated carbon filters should follow the particulate and oil filters. Moisture removal can be achieved by either compression or cooling (for large-scale system), which lowers the holding capacity of the air, and by desiccant drying, which strips the moisture from the air with a special medium. Desiccant dryers are required for all air preparation systems. Large or small particles and moisture cause arcing which damages generator dielectrics.

Typically, desiccant dryers are supplied with dual towers to allow regeneration of the saturated tower while the other is in service. Moisture is removed from the dryer by either an external heat source or by passing a fraction (10 to 30 percent) of the dried air through the saturated tower at reduced pressure. Formerly, small systems that require only intermittent use of ozone, a single desiccant tower is sufficient, provided that it is sized for regeneration during ozone decomposition time.

Air preparation systems can be classified by the operating pressure: ambient, low (less than 30 psig), medium, and high (greater than 60 psig) pressure. The distinguishing feature between low and high pressure systems is that high pressure systems can use a heatless dryer. A heatless dryer operates normally in the 100 psig range, rather than the 60 psig range. Rotary lobe, centrifugal, rotary screw, liquid ring, vane, and reciprocating compressors can be used in air preparation systems. Table 3-1 lists the characteristics of many of these types of compressors.

Reciprocating and liquid ring compressors are the most common type used in the United States, particularly in small systems, the former because the technology is so prevalent and the latter because liquid ring compressors do not need aftercoolers. Air receivers are commonly used to provide variable air flow from constant volume compressors. Oil-less compressors are used in modern systems to avoid hydrocarbons in the feed gas (Dimitriou, 1990).



**Figure 3-5. Schematic of an Air Preparation System**

**Table 3-1. Types of Compressors Used in Air Preparation Systems**

Compressor Type	Pressure	Volume	Comments
Rotary lobe	Low – 15 psi	Constant or variable with unloading	Common in Europe
Centrifugal	30 – 100 psi depending on no. of stages	Variable, high volume	Medium efficiency, cost effective in high volumes
Rotary Screw	50 psi (single stage) to 100 psi (2 stage)	Variable with unloading	Slightly more efficient than rotary lobe, draws approximately 40% of full load power in unloaded state, available in non-lubricated design for larger capacities.
Liquid Ring	10–80 psi	Constant volume	Does not require lubrication or aftercooler, relatively inefficient, common in United States.
Vane	High - to 100 psi	Constant or variable	Relatively inefficient, not common in U.S.

Table 3-2 presents a comparison of the advantages and disadvantages of each gas feed system.

**Table 3-2. Comparison of Air and High Purity Oxygen Feed Systems**

Source	Advantages	Disadvantages
Air	<ul style="list-style-type: none"> <li>• Commonly used equipment</li> <li>• Proven technology</li> <li>• Suitable for small and large systems</li> </ul>	<ul style="list-style-type: none"> <li>• More energy consumed per ozone volume produced</li> <li>• Extensive gas handling equipment required</li> <li>• Maximum ozone concentration of 3-5%</li> </ul>
Oxygen (general)	<ul style="list-style-type: none"> <li>• Higher ozone concentration (8-14%)</li> <li>• Approximately doubles ozone concentration for same generator</li> <li>• Suitable for small and large systems</li> </ul>	<ul style="list-style-type: none"> <li>• Safety concerns</li> <li>• Oxygen resistant materials required</li> </ul>
LOX	<ul style="list-style-type: none"> <li>• Less equipment required</li> <li>• Simple to operate and maintain</li> <li>• Suitable for small and intermediate systems</li> <li>• Can store excess oxygen to meet peak demands</li> </ul>	<ul style="list-style-type: none"> <li>• Variable LOX costs</li> <li>• Storage of oxygen onsite (Fire Codes, i.e. safety concerns)</li> <li>• Loss of LOX in storage when not in use</li> </ul>
Cryogenic Oxygen Generation	<ul style="list-style-type: none"> <li>• Equipment similar to air preparation systems</li> <li>• Feasible for large systems</li> <li>• Can store excess oxygen to meet peak demands</li> </ul>	<ul style="list-style-type: none"> <li>• More complex than LOX</li> <li>• Extensive gas handling equipment required</li> <li>• Capital intensive</li> <li>• Complex systems to operate and maintain</li> </ul>

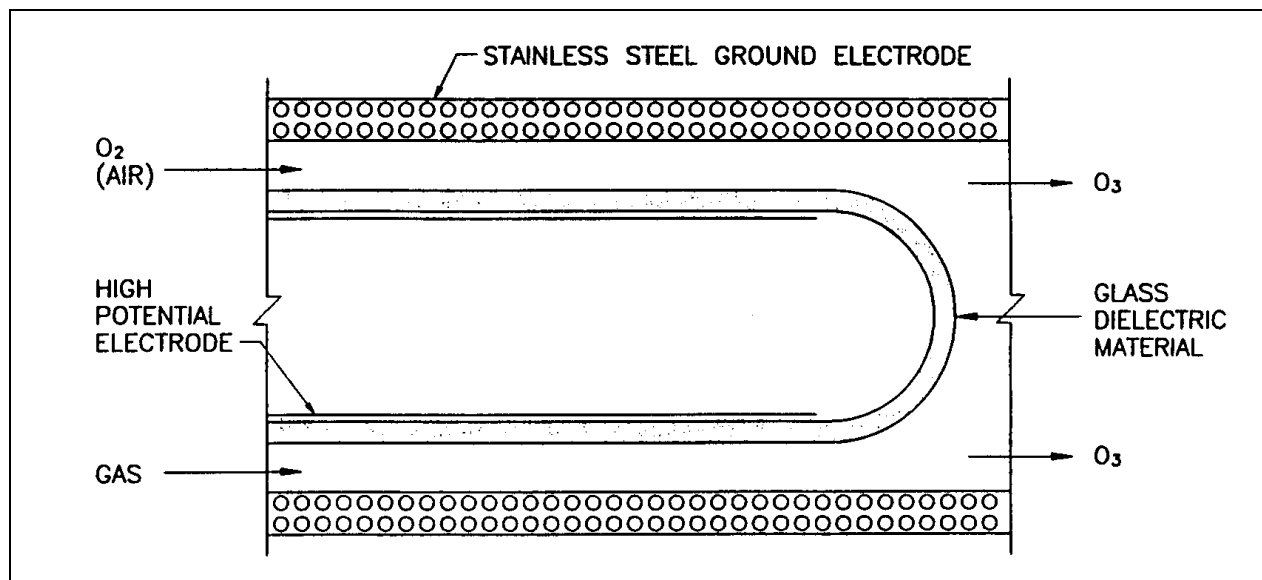
### 3.2.2.2 Ozone Generators

The voltage required to produce ozone by corona discharge is proportional to the pressure of the source gas in the generator and the width of the discharge gap. Theoretically, the highest yield (ozone produced per unit area of dielectric) would result from a high voltage, a high frequency, a large dielectric constant, and a thin dielectric. However, there are practical limitations to these parameters. As the voltage increases, the electrodes and dielectric materials are more subject to failure. Operating at higher frequencies produces higher concentrations of ozone and more heat requiring increased cooling to prevent ozone decomposition. Thin dielectrics are more susceptible to puncturing during maintenance. The design of any commercial generator requires a balance of ozone yield with operational reliability and reduced maintenance.

Two different geometric configurations for the electrodes are used in commercial ozone generators: concentric cylinders and parallel plates. The parallel plate configuration is commonly used in small generators and can be air cooled. Figure 3-6 shows the basic arrangement for the cylindrical configuration. The glass dielectric/high voltage electrode in commercial generators resembles a fluorescent light bulb and is commonly referred to as a “generator tube.”

Most of the electrical energy input to an ozone generator (about 85 percent) is lost as heat (Rice, 1996). Because of the adverse impact of temperature on the production of ozone, adequate cooling should be provided to maintain generator efficiency. Excess heat is removed usually by water

flowing around the stainless steel ground electrodes. The tubes are arranged in either a horizontal or vertical configuration in a stainless steel shell, with cooling water circulating through the shell.



**Figure 3-6. Cylindrical Electrode Schematic**

Ozone generators are classified by the frequency of the power applied to the electrodes. Low frequency (50 or 60 Hz) and medium frequency (60 to 1,000 Hz) generators are the most common found in the water industry, however some high frequency generators are available. Table 3-3 presents a comparison of the three types of generators. Medium frequency generators are efficient and can produce ozone economically at high concentrations, but they generate more heat than low frequency generators and require a more complicated power supply to step up the frequency supplied by utility power. New installations tend to use medium or high frequency generators.

### 3.2.2.3 Ozone Contactors

Once ozone gas is transferred into water, the dissolved ozone reacts with the organic and inorganic constituents, including any pathogens. Ozone not transferred into the process water during contacting is released from the contactor as off-gas. Transfer efficiencies of greater than 80 percent typically are required for efficient ozone disinfection (DeMers and Renner, 1992).

Common ozone dissolution methods include:

- Bubble diffuser contactors;
- Injectors; and
- Turbine mixers.

**Table 3-3. Comparison of Primary Characteristics of Low, Medium, and High Frequency Ozone Generators**

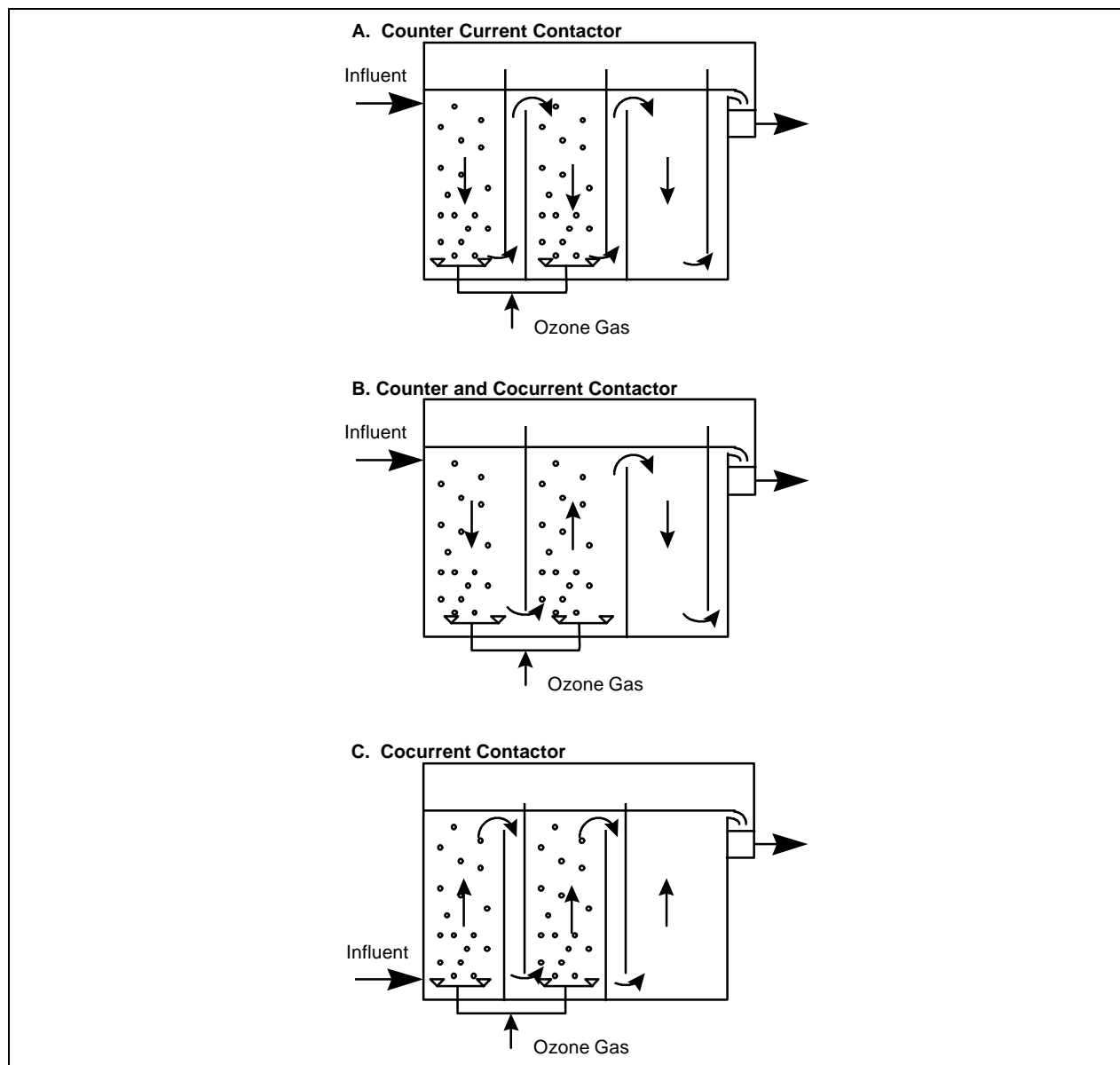
Characteristic	Low Frequency (50 - 60 Hz)	Medium Frequency (up to 1,000 Hz)	High Frequency (> 1,000 Hz)
Degree of Electronics Sophistication	low	high	high
Peak Voltages	19.5	11.5	10
Turndown Ratio	5:1	10:1	10:1
Cooling Water Required (gal/lb of ozone produced)	0.5 to 1.0	0.5 to 1.5	0.25 to 1
Typical Application Range	< 500 lb/day	to 2,000 lb/day	to 2,000 lb/day
Operating Concentrations			
wt - % in air	0.5 to 1.5%	1.0 to 2.5%+	1.0 to 2.5%+
wt - % in oxygen	2.0 to 5.0%	2 to 12%	2 to 12%
Optimum Ozone Production (as a proportion of total generator capacity)	60 to 75%	90 to 95%	90 to 95%
Optimum Cooling Water Differential	8° to 10°F	5° to 8°F	5° to 8°F
Power Required (kW-h/lb O <sub>3</sub> )	air feed: 8 to 12 O <sub>2</sub> feed: 4 to 6	air feed: 8 to 12 O <sub>2</sub> feed: 4 to 6	air feed: 8 to 12 O <sub>2</sub> feed: 4 to 6
Air Feed System Power Requirements (kW-h/lb O <sub>3</sub> )	5 to 7	5 to 7	5 to 7

Source: Adapted from Rice, 1996, with modifications.

### Bubble Diffuser Contactors

The bubble diffuser contactor is commonly used for ozone contacting in the United States and throughout the world (Langlais et al., 1991). This method offers the advantages of no additional energy requirements, high ozone transfer rates, process flexibility, operational simplicity, and no moving parts. Figure 3-7 illustrates a typical three stage ozone bubble diffuser contactor. This illustration shows a countercurrent flow configuration (ozone and water flowing in opposite directions), an alternating cocurrent/countercurrent arrangement, and a cocurrent flow configuration (ozone and water flowing in the same direction). Also, the number of stages can vary from two to six for ozone disinfection, with the majority of plants using two or three chambers for contacting and reaction (Langlais et al., 1991).

Bubble diffuser contactors are typically constructed with 18 to 22 ft water depths to achieve 85 to 95 percent ozone transfer efficiency. Since all the ozone is not transferred into the water, the contactor chambers are covered to contain the off-gas. Off-gas is routed to an ozone destruct unit, usually catalysts, thermal, or thermal/catalysts.



**Figure 3-7. Ozone Bubble Contactor**

Bubble diffuser contactors use ceramic or stainless steel diffusers that are either rod-type or disc-type to generate bubbles. Design considerations for these diffusers (Renner et al., 1988) include:

- Gas flow range of 0.5 to 4.0 scfm;
- Maximum headloss of 0.5 psig;
- Permeability of 2 to 15 cfm/ft<sup>2</sup>/in of diffuser thickness; and porosity of 35 to 45 percent.

The configuration of the bubble diffuser contactor structure should best be designed to provide plug flow hydraulics. This configuration will minimize the overall volume of the contactor while still

meeting the CT requirements for the system. Contactor volume is determined in conjunction with the applied ozone dosage and estimated residual ozone concentration to satisfy the disinfection CT requirement.

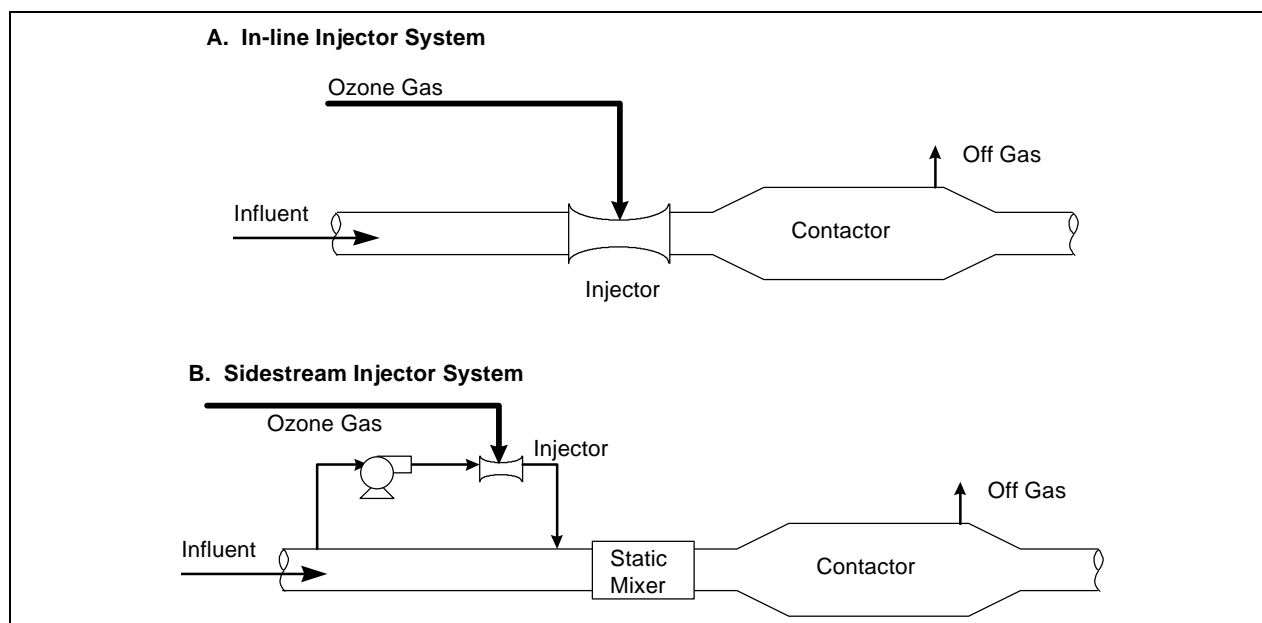
Table 3-4 summarizes the advantages and disadvantages of the bubble diffuser contactor (Langlais et al., 1991). Also, diffuser pore clogging can be a problem when ozone dosages are intermittent and/ or when iron and manganese oxidation is required. Channeling of bubbles is dependent on the type of diffusers used and the spacing between diffusers.

**Table 3-4. Bubble Diffuser Contactor Advantages and Disadvantages**

Advantages	Disadvantages
No moving parts	Deep contact basins
Effective ozone transfer	Vertical channeling of bubbles
Low hydraulic headloss	Maintenance of gaskets and piping.
Operational simplicity	

### Injector Dissolution

The injector contacting method is commonly used in Europe, Canada, and the United States (Langlais et al., 1991). Ozone is injected into a water stream under negative pressure, which is generated in a venturi section, pulling the ozone into the water stream. In many cases, a sidestream of the total flow is pumped to a higher pressure to increase the available vacuum for ozone injection. After the ozone is injected into this sidestream, the sidestream containing all the added ozone is combined with the remainder of the plant flow under high turbulence to enhance dispersion of ozone into the water. Figure 3-8 illustrates typical in-line and sidestream ozone injection systems.



**Figure 3-8. Sidestream Ozone Injection System**

The gas to liquid ratio is a key parameter used in the design of injector contacting systems. This ratio should be less than 0.067 cfm/gpm to optimize ozone transfer efficiency (Langlais et al., 1991). Meeting this criterion typically requires relatively low ozone dosages and ozone gas concentrations greater than 6 percent by weight (DeMers and Renner, 1992). High concentration ozone gas can be generated using a medium-frequency generator and/or liquid oxygen as the feed gas.

To meet the CT disinfection requirements, additional contact time is required after the injector, typically in a plug flow reactor. The additional contact volume is determined in conjunction with the applied ozone dosage and estimated residual ozone concentration to satisfy the disinfection CT requirement.

Table 3-5 summarizes the advantages and disadvantages of injection contacting (Langlais et al., 1991).

**Table 3-5. Injection Contacting Advantages and Disadvantages**

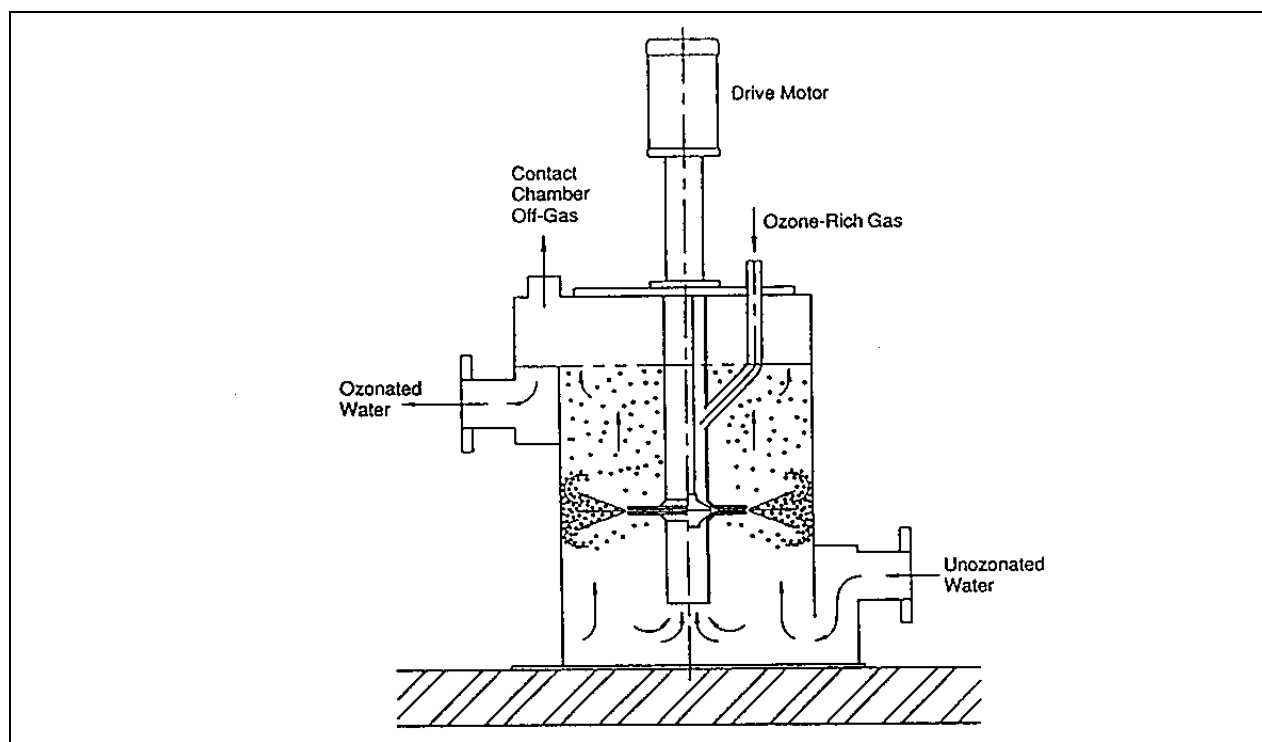
Advantages	Disadvantages
Injection and static mixing have no moving parts	Additional headloss (energy usage) due to static mixers which may require pumping
Very effective ozone transfer	Turndown capability limited by injection system
Contactors depth less than bubble diffusion	More complex operation and high cost.

### Turbine Mixer Contactors

Turbine mixers are used to feed ozone gas into a contactor and mix the ozone with the water in the contactor. Figure 3-9 illustrates a typical turbine contactor. The illustrated turbine mixer design shows the motor located outside the basin, allowing for maintenance access. Other designs use a submerged turbine.

Ozone transfer efficiency for turbine mixers can be in excess of 90 percent. However, the power required to achieve this efficiency is 2.2 to 2.7 kW-hr of energy per lb of ozone transferred (Dimitriou, 1990).

Turbine mixing basins vary in water depth from 6 to 15 ft, and dispersion areas vary from 5 to 15 ft (Dimitriou, 1990). Again, as with injector contacting, sufficient contact time may not be available in the turbine basin to meet disinfection CT requirements; consequently additional contact volume may be required.



**Figure 3-9. Turbine Mixer Ozone Contactor**

Table 3-6 summarizes advantages and disadvantages for the turbine mixer contactor (Langlais et al., 1991).

**Table 3-6. Turbine Mixer Contactor Advantages and Disadvantages**

Advantages	Disadvantages
Ozone transfer is enhanced by high turbulence resulting in small bubble size	Require energy input
Contactor depth less than bubble diffusion	Constant gas flow rate should be maintained, reducing ozone transfer efficiency
Aspirating turbines can draw off-gas from other chambers for reuse	Maintenance requirements for turbine and motor
Eliminates diffuser clogging concerns	

### 3.2.2.4 Off-gas Destruction Systems

The concentration of ozone in the off-gas from a contactor is usually well above the fatal concentration. For example, at 90 percent transfer efficiency, a 3 percent ozone feed stream will still contain 3,000 ppm of ozone in the off-gas. Off-gas is collected and the ozone converted back to oxygen prior to release to the atmosphere. Ozone is readily destroyed at high temperature ( $> 350^{\circ}\text{C}$  or by a catalyst operating above  $100^{\circ}\text{C}$ ) to prevent moisture buildup. The off-gas destruct unit is designed to reduce the concentration to 0.1 ppm of ozone by volume, the current limit set by OSHA

for worker exposure in an eight hour shift. A blower is used on the discharge side of the destruct unit to pull the air from the contactor, placing the contactor under a slight vacuum to ensure that no ozone escapes.

### **3.2.2.5 Instrumentation**

Instrumentation should be provided for ozone systems to protect both personnel and the equipment. Gas phase ozone detectors should be provided in spaces such as generator rooms where ozone gas may be and personnel are routinely present. An ozone detector is also needed on the outlet from the off-gas destruct unit to ensure the unit is working properly. These units should be interlocked with the ozone generator controls to shut down the ozone generation system should excess ozone be detected. A dew point detector on the feed gas supply just upstream of an ozone generator is required to protect the generator from moisture in the feed gas (when air is the feed gas). Flow switches on the cooling water supply are needed to protect the generator from overheating and a pressure switch to prevent over pressurization.

Other instrumentation can be used to monitor and control the ozone process, although manual control is adequate for small systems, but most small systems are designed to operate automatically, particularly in remote areas. Ozone monitors can be used in conjunction with process flow meters to match ozone dose to process demands and control ozone generation. Sophisticated control schemes can be implemented to minimize the cost of dosing with ozone and reduce operator attention requirements. Many systems include residual monitoring at various points in the contactor to maintain a desired ozone residual and prevent energy-wasting overdosing.

## **3.2.3 Operation and Maintenance**

Even though ozone systems are complex, using highly technical instruments, the process is highly automated and very reliable, requiring only a modest degree of operator skill and time to operate an ozone system. Maintenance on generators requires skilled technicians. If trained maintenance staff are not available at the plant, this work can be done by the equipment manufacturer. Some facilities, such as the 600 mgd Los Angeles Aqueduct Filtration Plant, use plant mechanics to perform generator and facilities maintenance. Therefore, backup units are usually installed. Generators should be checked daily when in operation. After a shutdown, dry air or oxygen should be allowed to flow through the generator to ensure that any moisture has been purged prior to energizing the electrodes. At initial start up and after long down times, this process may take up to 12 hours and usually longer when air is the feed gas. As an alternative, a small flow of dry air can be passed through the generator continuously when it is in standby mode to maintain the dry condition.

Filters and desiccant in air preparation systems should be changed periodically, with the frequency depending on the quality of the inlet air and the number of hours in operation. Compressors require periodic service, depending on the type and operating time. LOX tanks should be periodically pressure tested. Piping and contact chambers should be inspected periodically to check for leaks and corrosion.

Dielectric tubes should be periodically cleaned. This operation should be performed when the generator efficiency drops 10-15 percent. Cleaning the tubes is a delicate operation as the tubes are fragile and expensive. Adequate space should be provided for the cleaning operation and for storage of spare tubes.

## **3.3 Primary Uses and Points of Application of Ozone**

### **3.3.1 Primary Uses of Ozone**

Ozone is used in drinking water treatment for a variety of purposes including:

- Disinfection;
- Inorganic pollutant oxidation, including iron, manganese, and sulfide;
- Organic micropollutant oxidation, including taste and odor compounds, phenolic pollutants, and some pesticides; and
- Organic macropollutant oxidation, including color removal, increasing the biodegradability of organic compounds, DBP precursor control, and reduction of chlorine demand.

#### **3.3.1.1 Disinfection**

Ozone is a powerful oxidant able to achieve disinfection with less contact time and concentration than all weaker disinfectants, such as chlorine, chlorine dioxide, and monochloramine (Demers and Renner, 1992). However, ozone can only be used as a primary disinfectant since it cannot maintain a residual in the distribution system. Thus, ozone disinfection should be coupled with a secondary disinfectant, such as chlorine, chloramine, or chlorine dioxide for a complete disinfection system.

#### **3.3.1.2 Iron and Manganese Oxidation**

Ozone will oxidize iron and manganese, converting ferrous (2+) iron into the ferric (3+) state and 2+ manganese to the 4+ state. The oxidized forms will precipitate as ferric hydroxide and manganese hydroxide (AWWA, 1990). The precise chemical composition of the precipitate will depend on the nature of the water, temperature, and pH. The ozone dose required for oxidation is 0.43 mg/mg iron and 0.88 mg/mg manganese (Langlais et al., 1991). Iron oxidizes at a pH of 6-9 but manganese is more effective at a pH of around 8. Also, over-ozonation has no effect on iron, but will resolubilize manganese, which then should be reduced to manganese dioxide downstream.

#### **3.3.1.3 Oxidation of Taste and Odor Compounds**

Ozone is used to oxidize/destroy taste and odor-causing compounds because many of these compounds are very resistant to oxidation. Suffet et al. (1986) confirmed that ozone is an effective oxidant for use in taste and odor treatment. They found ozone doses of 2.5 to 2.7 mg/L and 10 minutes of contact time (ozone residual of 0.2 mg/L) significantly reduced taste and odors in the

specific waters they tested. Most early U.S. water plants (i.e., 1940-1986) installed ozonation specifically for taste and odor removal.

#### **3.3.1.4 DBP Precursor Control**

Early work on oxidation of DBP precursors seemed to indicate that the effects of ozonation, prior to chlorination, were quite site-specific and unpredictable (Umphries et al., 1979). The key variables that seem to determine ozone's effect are dose, pH, alkalinity, and, above all, the nature of the organic material. At low pH levels, precursor destruction by ozone is quite effective; however, above some critical pH, ozone actually is less effective and in fact sometimes increases the amount of chlorination byproduct precursors. For most humic substances this critical pH is 7.5, which is the approximate level at which decomposition of ozone to hydroxyl free radicals increases rapidly, thus increasing organic oxidation rates. Therefore, the implications that at lower pH (approximately 6-7), at which molecular ozone predominates over the hydroxyl free radical, the initial THM precursor by-products are different in nature than those formed by the hydroxyl free radicals oxidized at higher pH levels. This is logical in light of the greater oxidation potential of the hydroxyl free radical over that of ozone.

As alkalinity increases, it has a beneficial effect on THM formation potential (THMFP) (Langlais et al., 1991). This is because alkalinity scavenges any hydroxyl free radicals formed during ozonation, leaving molecular ozone as the sole oxidant, which is only capable of oxidizing organic precursors to a lower oxidation sequence than does the hydroxyl free radical. Given neutral pH and moderate levels of bicarbonate alkalinity, THMFP level reductions of 3 to 20 percent have been shown at ozone doses ranging from 0.2 to 1.6 mg ozone per mg carbon (Singer et al., 1989; Georgeson and Karimi, 1988).

#### **3.3.1.5 Increase Organic Biodegradation**

Ozone can be effective in partially oxidizing organics in the water to biodegradable compounds that can be removed by biological filtration (Demers and Renner, 1992). This partial oxidation gives rise to lower molecular weight organics that are more easily biodegradable. This increase in the biodegradable fraction of organic carbon occurs as a result of moderate to high levels of ozonation. These ozone levels are typical of the doses commonly applied for disinfection.

#### **3.3.1.6 Coagulation and Filtration Improvement**

Ozone has been reported by some to improve coagulation and filtration efficiency (Gurol and Pidotella, 1993; Farvardin and Collins, 1990; Reckhow et al., 1993; Stolarik and Christie, 1997). However, others have found no improvement in filter effluent turbidity due to ozonation (Tobiason et al., 1992; Hildebrand et al., 1986). Prendiville (1986) collected data from a large water treatment plant showing that pre-ozonation was more effective than pre-chlorination to reduce filter effluent turbidities. The cause of the improved coagulation is not clear, but several possibilities have been offered (Reckhow et al., 1986), including:

- Oxidation of organic compounds into more polar forms; and
- Oxidation of metals ions to yield insoluble complexes, such as ferric iron complexes.

### 3.3.2 Points of Application

The typical locations for feeding ozone in a water treatment plant are at the head of the treatment plant (raw water) pre-ozonation and after sedimentation.

Raw water quality and turbidity and ozone demand (the amount of ozone required for all oxidation requirements of the water) can be used to assess how to use ozone in the treatment process. Table 3-7 lists the criteria for selecting ozone feed points based on these two parameters. By moving the ozonation process further downstream after sedimentation, the ozone demand and production of byproducts are reduced. The advantage of placing ozone ahead of filtration is that biodegradable organics produced during ozonation can be removed by subsequent biological activity in the filters.

**Table 3-7. Criteria for Selecting Ozone Feed Points for Small Systems**

Raw Water Quality	Ozone Feed Point(s)	Special Considerations
<b>Category I</b> Turbidity < 10 NTU Ozone Demand < 1mg/L	Raw Water or After Sedimentation	Low ozone demand. Low disinfection byproducts. Low biodegradable organics.
<b>Category II</b> Turbidity > 10 NTU Ozone Demand < 1mg/L	After Sedimentation	Low ozone demand. High inorganic particulate. Low biodegradable organics.
<b>Category III</b> Turbidity < 10 NTU Ozone Demand > 1mg/L	Raw Water and/or After Sedimentation	High ozone demand Disinfection byproducts Biodegradable organics formation
<b>Category IV</b> Turbidity > 10 NTU Ozone Demand > 1mg/L	After Sedimentation and After First Stage Filtration, if necessary	High ozone demand Disinfection byproducts Biodegradable organics formation

Source: DeMers and Renner, 1992.

For high quality water with direct filtration, the only practical ozone feed point is the raw water.

Category II (Table 3-7) water is characterized by low ozone demand and high turbidity. This water quality indicates the presence of inorganic material, such as clay or silt particles. For ozone to be most effective for Category II water disinfection, it should be added after either pre-sedimentation or conventional sedimentation.

Raw water with low turbidity and high ozone demand (Category III, Table 3-7) contains dissolved constituents, not suspended, that contribute to a high ozone demand. An example of this type of water is a ground water containing bromide ion, iron, manganese, color, or organics. For this water quality, ozone can be added to either the raw water or after sedimentation. If the water contains organic constituents that become more biodegradable by ozonation, a biological treatment step (see

Section 3.3.4) may be required. The presence of oxidizable organic constituents or bromide ion will generate disinfection byproducts upon ozonation.

Category IV (Table 3-7) water would be considered the most difficult water to treat with ozone due to its high turbidity and high ozone demand. An example of this water quality is surface water containing high concentrations of organic material and inorganic particles. The most effective use of ozone for this water quality is after sedimentation and possibly after filtration. If the water has an extremely high ozone demand, dual ozone feed points may be required to achieve disinfection goals, because the presence of large amounts of organic material may require a biological treatment step and may generate disinfection byproducts.

### 3.3.3 Impact on Other Treatment Processes

Ozonation does have an impact on other processes at the water treatment facility. The impacts of ozone addition include the following:

- The use of ozone generates biodegradable organic matter (BOM) that can result in biological growth which may also increase corrosion rates in distribution systems if not removed by biologically active filtration. When ozonation is placed before biological filters, it can impact the filters by increasing biological growth and increasing backwash frequency.
- Ozone is a strong oxidant that reacts with other oxidants, such as chlorine, chlorine dioxide, and monochloramine.
- Ozone oxidation of iron and manganese generates insoluble oxides that should be removed by sedimentation or filtration. These insoluble oxides also impact the filters by increasing load on the filters and increasing backwash frequency.
- Using pre- and/or internal ozone on most raw waters reduces the subsequent chlorine, chlorine dioxide, or monochloramine demand of the finished water so as to allow a stable chlorine-compound residual to be maintained at a much lower level.

The reader is referred to EPA's *Simultaneous Compliance Guidance Document* (expected to be available in 1999) for additional information regarding the interaction between oxidants and other treatment processes.

### 3.3.4 Biologically Active Filtration

Ozonation typically increases the biodegradability of NOM in water because many large organic molecules are converted into smaller organic molecules that are readily biodegradable. This increase in biodegradable dissolved organic carbon (BDOC) can lead to accelerated bacterial growth and regrowth in the distribution system if not removed in the treatment plant. LeChevallier et al. (1992) found that AOC levels less than 100 ppb may be necessary to control excessive bacterial regrowth in the distribution system if not removed in the treatment plant.

When ozonation is placed upstream of filtration, and environmental conditions such as dissolved oxygen, pH, and temperature are favorable, microbiological activity is increased in the filter and BDOC/AOC removal is enhanced. Ozone addition not only increases the biodegradability of the

dissolved organics, but also introduces large amounts of oxygen to the water, thus, creating an excellent environment for biological growth on the filter media. The advantages of biologically active filtration (Price, 1994) include the following which are all being met in most U.S. plants using ozone:

- Production of a biologically stable water that does not promote excessive bacterial growth and regrowth in the distribution system.
- Removal of NOM that can serve as precursors to byproduct formation as a result of residual disinfection with free or combined chlorine.
- Ozone oxidation as a primary disinfectant prior to biologically active filtration reduces the BDOC concentration in finished water, thus reducing chances of regrowth.
- Reduction of the residual disinfectant demand of the product water so that proposed regulations limiting the maximum disinfectant residual can be met.
- Removal or control of ozonation byproducts.

Biological activity can be supported on slow sand, rapid rate, and GAC media because these media provide a surface for bacteria to attach. Factors such as available surface area, hydraulic loading rate, contact time, availability of nutrients, temperature, and others will determine the performance and BDOC removal efficiency. Biomass develops to higher levels on GAC because of the rougher surface characteristics than on anthracite and sand.

#### **3.3.4.1 Slow Sand Filters**

Ozone addition prior to slow sand filtration can increase the efficiency of TOC removal by about 35 percent (Rachwal et al., 1988; Zabel, 1985). Ozone addition can also increase the efficiency of BDOC removal with slow sand filters (Eighmy et al., 1991; Malley et al., 1993).

#### **3.3.4.2 Rapid Rate Filters**

Research in the area of biologically active rapid rate filters has focused on the reduction of assimilable organic carbon (AOC) instead of BDOC. While studies have shown rapid rate filtration, employing either sand or dual media lowers AOC levels following ozonation, AOC does not measure all the BDOC. AOC measures only that portion of the BDOC that is more easily assimilable or more easily biodegradable under specific laboratory conditions by two specific microorganisms. Research data shows that biodegradation of AOC can occur in rapid rate filters. The data should be viewed with caution, since the more slowly biodegradable DOC, not measured by AOC, may be passing through rapid rate filters.

### 3.3.4.3 Granular Activated Carbon

GAC is made biologically active by the deliberate introduction of sufficient dissolved oxygen to water just before passing through GAC columns (Katz, 1980). The high surface area and long retention time in GAC provide an ideal environment to enhance biological growth.

Although ozone actually increases the amount of BDOC, the efficiency of subsequent biodegradation on GAC can be such that the BDOC in GAC effluent is lower than the BDOC in the ozone influent (Langlais et al., 1991). The degree to which biodegradable DOC is removed by ozone/GAC depends upon the process conditions of temperature, amount of BDOC, and the GAC column loading rate, measured by empty bed contact time (EBCT). For example, with an influent BDOC of 0.65 mg C/L and a 10 minute EBCT, one would expect an effluent BDOC of 0.25 mg C/L. The effluent BDOC then could be lowered by either:

- Adding ozone, which would increase the GAC influent BDOC and, therefore, lower the effluent BDOC; or
- Adding more GAC or decreasing the loading rate, which would extend the EBCT and lower the effluent BDOC (Billen et al., 1985, as cited in Langlais et al., 1991).

Huck et al. (1991) reported results from AOC profiles measured in a pilot treatment plant. The plant treated Saskatchewan River water and included coagulation, flocculation, and sedimentation prior to ozonation. Following ozonation, the water was filtered through a dual media (anthracite-sand) filter followed by GAC adsorption. The results demonstrate:

- Variable AOC removal through coagulation, flocculation, and sedimentation (80 percent to zero);
- Increased AOC after ozonation;
- AOC removal through dual media filtration improving at lower hydraulic loading rates and filtered effluent AOC often less than raw water AOC, but highly variable; and
- AOC levels after GAC were low, almost always below raw water AOC concentrations and adsorption appears to contribute to some immediate AOC removal.

### 3.3.5 Pathogen Inactivation and Disinfection Efficacy

Ozone has a high germicidal effectiveness against a wide range of pathogenic organisms including bacteria, protozoa, and viruses. Because of its high germicidal efficiency, ozone can be used to meet high inactivation required by water treatment systems with or without filters. However, ozone cannot be used as a secondary disinfectant because the ozone residual decays too rapidly. The ozone disinfection efficiency is not affected by pH (Morris, 1975), although because of hydroxyl free radicals and rapid decay, efficiency is the same but more ozone should be applied at high pH to maintain “C”.

### 3.3.6 Inactivation Mechanisms

Inactivation of bacteria by ozone is attributed to an oxidation reaction (Bringmann, 1954; Chang, 1971). The first site to be attacked appears to be the bacterial membrane (Giese and Christensen, 1954) either through the glycoproteins or glycolipids (Scott and Leshner, 1963) or through certain amino acids such as typtophan (Goldstein and McDonagh, 1975). In addition, ozone disrupts enzymatic activity of bacteria by acting on the sulfhydryl groups of certain enzymes. Beyond the cell membrane and cell wall, ozone may act on the nuclear material within the cell. Ozone has been found to affect both purines and pyrimidines in nucleic acids (Giese and Christensen, 1954; Scott and Leshner, 1963).

The first site of action for virus inactivation is the virion capsid, particularly its proteins (Cronholm et al., 1976 and Riesser et al., 1976). Ozone appears to modify the viral capsid sites that the virion uses to fix on the cell surfaces. High concentrations of ozone dissociate the capsid completely. One researcher found that the mechanism of ozone inactivation of bacteriophage f2 ribonucleic acid (RNA) included releasing RNA from the phage particles after the phage coat was broken into many pieces (Kim et al., 1980). This finding suggests that ozone breaks the protein capsid, thereby liberating RNA and disrupting adsorption to the host pili. Further, the naked RNA may be secondarily inactivated by ozone at a rate less than that for RNA within the intact phage. The mechanism for inactivation of deoxyribonucleic acid (DNA) bacteriophage T4 has been found to be quite similar to RNA inactivation: ozone attacks the protein capsid, liberates the nucleic acid, and inactivates the DNA (Sproul et al., 1982). In contrast, more recent work on the tobacco mosaic virus (TMV) shows that ozone has a specific effect on RNA. Ozone was found to attack both the protein coat and RNA. The damaged RNA cross-links with amino acids of the coat protein subunits. The authors concluded that TMV loses its infectivity because of its loss of protein coating.

Microscopic observation of inactivation of trophozoites of *Naegleria* and *Acanthamoeba* showed that they were rapidly destroyed and the cell membrane was ruptured (Perrine et al., 1984). Perrine and Langlais showed that ozone affect the plugs in *Naegleria gruberi* cysts (Langlais and Perrine, 1984). Depending on the ozonation conditions, these plugs were completely removed or were partially destroyed. It has been speculated that ozone initially affects the *Giardia muris* cysts wall and makes it more permeable (Wickramanayake, 1984c). Subsequently, aqueous ozone penetrates into the cyst and damages the plasma membranes, additional penetration of ozone eventually affects the nucleus, ribosomes, and other ultrastructural components.

### 3.3.7 Disinfection Parameters

Hoigné and Bader demonstrated that the rate of decomposition of ozone is a complex function of temperature, pH, and concentration of organic solutes and inorganic constituents (Hoigné and Bader, 1975, and 1976). The following sections describe the effects that pH, temperature, and suspended matter have on the reaction rate of ozone and pathogen inactivation.

The ability to maintain a high aqueous ozone concentration is critical from a regulatory disinfection compliance standpoint. This means that factors that accelerate ozone decomposition are undesirable for inactivation because the ozone residual dissipates faster and therefore reduces the CT credit, requiring a corresponding increase in the ozone applied, thus increasing cost.

### 3.3.7.1 pH

Studies have indicated that pH has little effect on the ability of dissolved ozone residuals to inactivate acid-fast bacteria, such as *Mycobacteria* and *Actinomycetes* (Farooq, 1976). A slight decrease has been found in the virucidal efficacy of ozone residuals as pH decreased (Roy, 1979). However, the opposite effect was observed by Vaughn et al. (1987) (cited in Hoff, 1986). Changes in disinfection efficacy with variations in pH appear to be caused by the ozone decomposition rate. Ozone decomposition occurs faster in higher-pH aqueous solutions and forms various types of oxidants with differing reactivities (Langlais et al., 1991). Tests carried out at constant ozone residual concentration and different pH values showed that the degree of microorganism inactivation remained virtually unchanged (Farooq et al., 1977). More recent studies have indicated decreased virus inactivation by ozone at alkaline pH (pH 8 to 9) for poliovirus 1 (Harakeh and Butler, 1984) and rotaviruses SA-11 and Wa (Vaughn et al., 1987).

Inactivation of *Giardia muris* cysts was found to improve when the pH increased from 7 to 9 (Wickramanayake, 1984a). This phenomenon was attributed to the possible changes in cyst chemistry making it easier for ozone to react with the cyst constituents at the higher pH levels. However, the same study found that inactivation of *Naegleria gruberi* cysts was slower at a pH 9 than at lower pH levels, thereby indicating that pH effects are organism-specific.

### 3.3.7.2 Temperature

As temperature increases, ozone becomes less soluble and less stable in water (Katzenelson et al., 1974); however, the disinfection and chemical oxidation rates remain relatively stable. Studies have shown that although increasing the temperature from 0 to 30°C can significantly reduce the solubility of ozone and increases its decomposition rate, temperature has virtually no effect on the disinfection rate of bacteria (Kinman, 1975). In other words, the disinfection rate was found to be relatively independent of temperature at typical water treatment plant operating temperatures despite the reduction in solubility and stability at higher temperatures.

### 3.3.7.3 Suspended Matter

Ozone inactivation of viruses and bacteria contained in aluminum floc (in the size range comparable to those that could typically escape filtration) was not reduced at floc turbidity levels of 1 and 5 NTU (Walsh et al., 1980). This study demonstrated that the microorganisms received no protection from the aluminum floc. Similar results have been obtained for poliovirus 1, coxsackie virus A9, and *E. coli* associated with bentonite clay (Boyce et al., 1981). However, adsorption of the f2 bacteriophage at 1 and 5 NTU of bentonite clay was found to retard the rate of inactivation of ozone (Boyce et al., 1981).

In some instances, river waters heavily polluted with organic matter were ozonated, and the results indicated a degradation of large organic molecules into fragments more easily metabolized by microorganisms. This fragmentation coupled with the inability of ozone to maintain an active concentration in the distribution system, has led to increased slime growth and, consequently, water quality deterioration during distribution (Trojan and Hanson, 1989).

### 3.3.8 Inactivation of Microorganisms

The following sections contain a description of the disinfection efficiency of ozone in terms of bacteria, virus, and protozoa inactivation.

#### 3.3.8.1 Bacterial Inactivation

Ozone is very effective against bacteria. Studies have shown the effect of small concentrations of dissolved ozone (i.e., 0.6 µg/L) on *E. coli*. (Wuhrmann and Meyrath, 1955) and *Legionella pneumophila* (Domingue, et al., 1988). *E. coli*. levels were reduced by 4 logs (99.99 percent removal) in less than 1 minute with a ozone residual of 9 µg/L at a temperature of 12°C. *Legionella pneumophila* levels were reduced by greater than 2 logs (99 percent removal) within a minimum contact time of 5 minutes at a ozone concentration of 0.21 mg/L. Results similar to those obtained for *E. coli*. have been found for *Staphylococcus* sp. and *Pseudomonas fluorescens* inactivation. *Streptococcus faecalis* required a contact time twice as long with the same dissolved ozone concentration, and *Mycobacterium tuberculosis* required a contact time six times as long for the same reduction level as *E. coli*.

In regard to vegetative bacteria, *E. coli* is one of the most sensitive types of bacteria. Furthermore, significant difference has been found among all the Gram-negative bacillae, including *E. coli* and other pathogens such as *Salmonella*, which are all sensitive to ozone inactivation. whereas the Gram-positive cocci (*Staphylococcus* and *Streptococcus*), the Gram-positive bacillae (*Bacillus*), and the *Mycobacteria* are the most resistant forms of bacteria. Sporular bacteria forms are always far more resistant to ozone disinfection than vegetative forms (Bablon, et al., 1991), but all are easily destroyed by relatively low levels of ozone.

#### 3.3.8.2 Protozoa Inactivation

Protozoan cysts are much more resistant to ozone and other disinfectants than vegetative forms of bacteria and viruses. *Giardia lamblia* has a sensitivity to ozone that is similar to the sporular forms of *Mycobacteria*. Both *Naegleria* and *Acanthamoeba* cysts are much more resistant to ozone (and all other disinfectants) than *Giardia* cysts. (Bablon et al., 1991). CT products for 99 percent inactivation of *Giardia lamblia* and *N. gruberi* at 5°C were 0.53 and 4.23 mg • min/L, respectively (Wickramanayake et al., 1984a and 1984b). Data available for inactivation of *Cryptosporidium* oocysts, suggest that among protozoans, this microorganism is more resistant to ozone (Peeters et al., 1989; Langlais et al., 1990). One study found that *Cryptosporidium* oocysts are approximately 10 times more resistant to ozone than *Giardia* (Owens et al., 1994).

### 3.3.8.3 Virus Inactivation

Typically, viruses are more resistant to ozone than vegetative bacteria but less resistant than sporular forms of *Mycobacteria* (Bablon, et al., 1991). The most sensitive forms of viruses are phages, and there seems to be little difference between the polio- and coxsackie viruses. The sensitivity of human rotavirus to ozone was determined to be comparable to that of *Mycobacteria* and polio- and coxsackie viruses (Vaughn et al., 1987).

Keller et al. (1974) studied ozone inactivation of viruses by using both batch tests and pilot plant data. Inactivation of poliovirus 2 and coxsackie virus B3 was more than 3 logs (99.9 percent) in the batch tests with an ozone residual of 0.8 mg/L and 1.7 mg/L and a contact time of 5 minutes. Greater than 5 log (99.999 percent) removal of coxsackie virus was achieved in the pilot plant with an ozone dosage of 1.45 mg/L, which provided an ozone residual of 0.28 mg/L in lake water.

### 3.3.8.4 CT Curves for *Giardia Lamblia*

CT values shown in Figure 3-9 are based on disinfection studies using in vitro excystation of *Giardia lamblia*. CT values obtained at 5°C and pH 7 were used as the basis for deriving the CT values at other temperatures. A safety factor of 2 has been applied to the values shown in Figure 3-9.

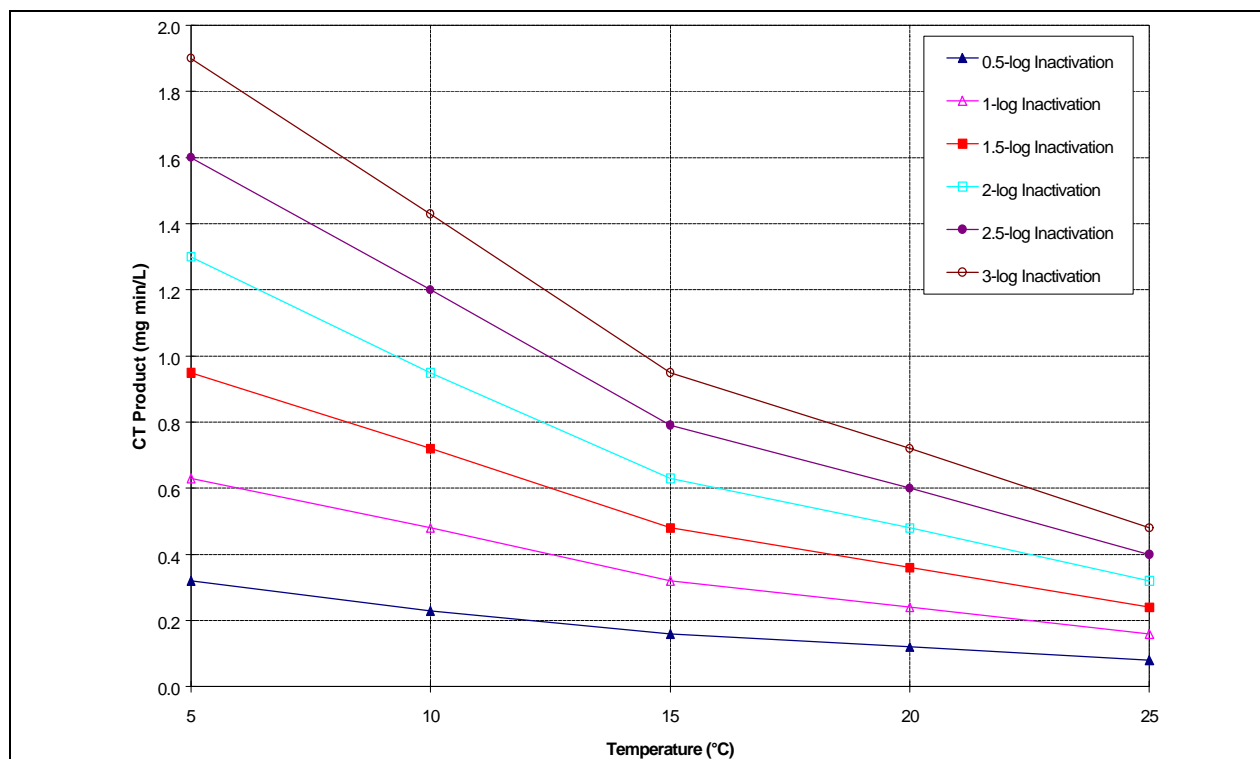


Figure 3-9. CT Values for Inactivation of *Giardia* Cysts by Ozone (pH 6 to 9)

CT values shown in Figure 3-10 for achieving 2-log inactivation of viruses were determined by applying a safety factor of 3 to data obtained from a previous study on poliovirus 1 (Roy et al., 1982). CT values for 3 and 4-log removal were derived by applying first order kinetics and assuming the same safety factor of 3. Data obtained at a pH of 7.2 was assumed to apply for the pH range of 6 to 9.

Several research groups have investigated the efficiency of ozone for *Cryptosporidium* oocyst inactivation. Table 3-8 summarizes CT values obtained for 99 percent inactivation of *Cryptosporidium* oocysts. Results indicate that ozone is one of the most effective disinfectants for controlling *Cryptosporidium* (Finch, et al., 1994) and that *Cryptosporidium muris* may be slightly more resistant to ozonation than *Cryptosporidium parvum* (Owens et al., 1994). A wide range of CT values has been reported for the same inactivation level, primarily because of the different methods of *Cryptosporidium* measurements employed and pH, temperature, and above all, ozonation conditions.

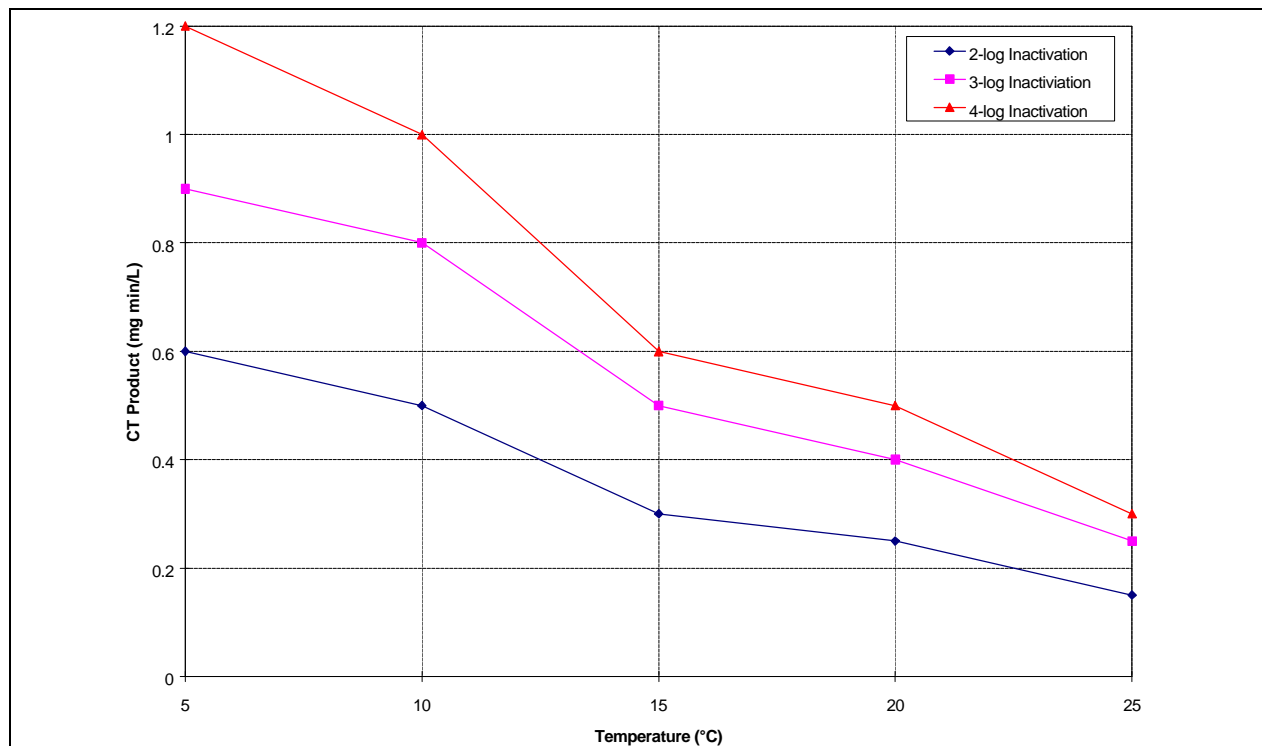


Figure 3-10. CT Values for Inactivation of Viruses by Ozone (pH 6 to 9)

**Table 3-8. Summary of Reported Ozonation Requirements for 99 Percent Inactivation of *Cryptosporidium* Oocysts**

Species	Ozone protocol	Ozone residual (mg/L)	Contact time (min)	Temperature (°C)	CT (mg.min/L)	Reference
<i>C. baileyi</i>	Batch liquid, modified batch ozone	0.6 & 0.8	4	25	2.4 - 3.2	Langlais et al., 1990
<i>C. muris</i>	Flow through contactor, continuous gas			22 - 25	7.8	Owens et al., 1994
<i>C. parvum</i>	Batch liquid, batch ozone	0.50	18	7	9.0	Finch et al., 1993
		0.50	7.8	22	3.9	
<i>C. parvum</i>	Batch liquid, batch ozone	0.77	6	Room	4.6	Peeters et al., 1989
		0.51	8		4	
<i>C. parvum</i>	Batch liquid, continuous gas	1.0	5 & 10	25	5 - 10	Korich et al., 1990
<i>C. parvum</i>	Flow through contactor, continuous gas			22 - 25	5.5	Owens et al., 1994

Ozone dose and contact time (CT) requirements for the inactivation of *Cryptosporidium* oocysts in drinking water when using ozone has not been established similar to the CT values for viruses and *Giardia* cyst inactivation. Inactivation requirements (log removals) for *Cryptosporidium* oocysts have not been established. In addition, as shown in Table 3-8, the CT requirements reported in the literature vary from study to study which adds uncertainty to design CT requirements for specific applications or regulatory needs.

### 3.4 Ozonation Disinfection Byproducts

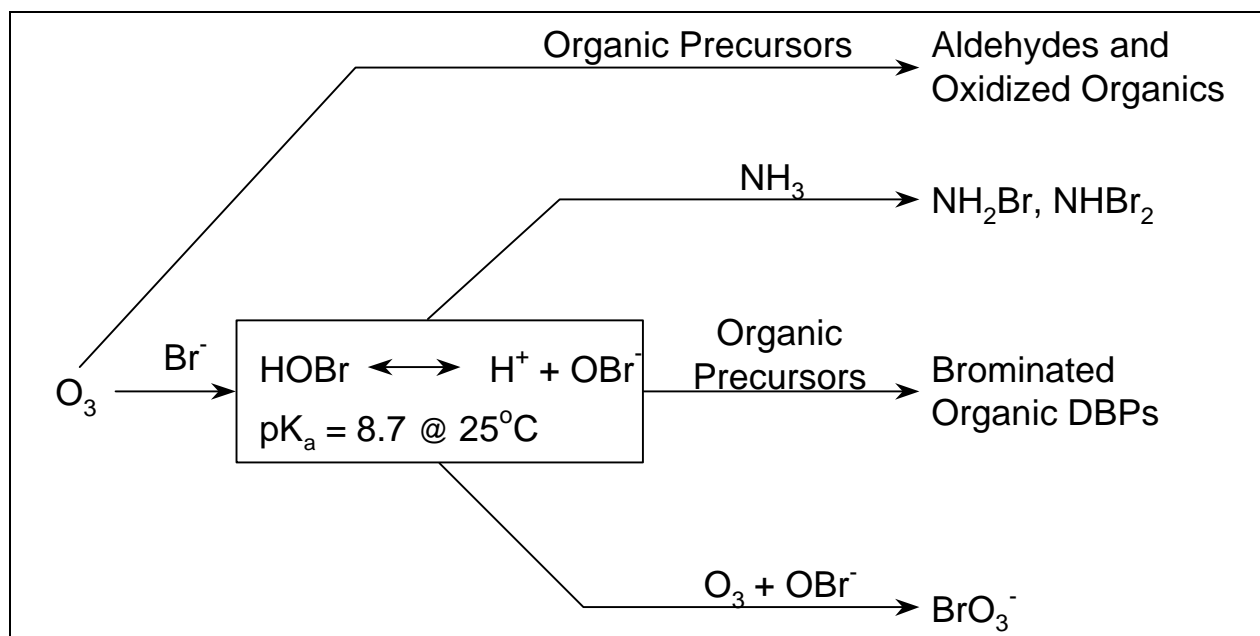
Ozone does not form halogenated DBPs (TTHMs and HAA5s) when participating in oxidation/reduction reactions with NOM but it does form a variety of organic and inorganic byproducts. Table 3-9 and Figure 3-11 show the principal known byproducts associated with ozonation. However, if bromide ion is present in the raw water halogenated DBPs may be formed. These brominated DBPs appear to pose a greater health risk than non-brominated DBPs.

**Table 3-9. Principal Known Byproducts of Ozonation**

Disinfectant Byproducts	
<b>Aldehydes</b>	<b>Aldo- and Ketoacids</b>
Formaldehyde	Pyruvic acid
Acetaldehyde	<b>Brominated Byproducts*</b>
Glyoxal	Bromate ion
Methyl Glyoxal	Bromoform
<b>Acids</b>	Brominated acetic acids
Oxalic acid	Bromopicrin
Succinic acid	Brominated acetonitriles
Formic acid	<b>Others</b>
Acetic acid	Hydrogen peroxide

\*Brominated byproducts are produced only in waters containing bromide ion  
Source: Singer, 1992.

Although ozone is an effective oxidant and disinfectant, it should not be relied upon as a secondary disinfectant to maintain a residual in the distribution system. Monochloramine is attractive for this purpose because it produces little to no halogenated DBPs. Chlorine is a candidate for secondary disinfectant but the ozonated water may actually produce either more or less DBPs following the addition of free chlorine depending on the nature of the organic material following ozonation unless biologically active filtration precedes the addition of chlorine. The principal benefit of using ozone for controlling DBP formation is that it allows free chlorine to be applied later in the treatment process after precursors have been removed and at lower doses, thereby reducing DBPFP.

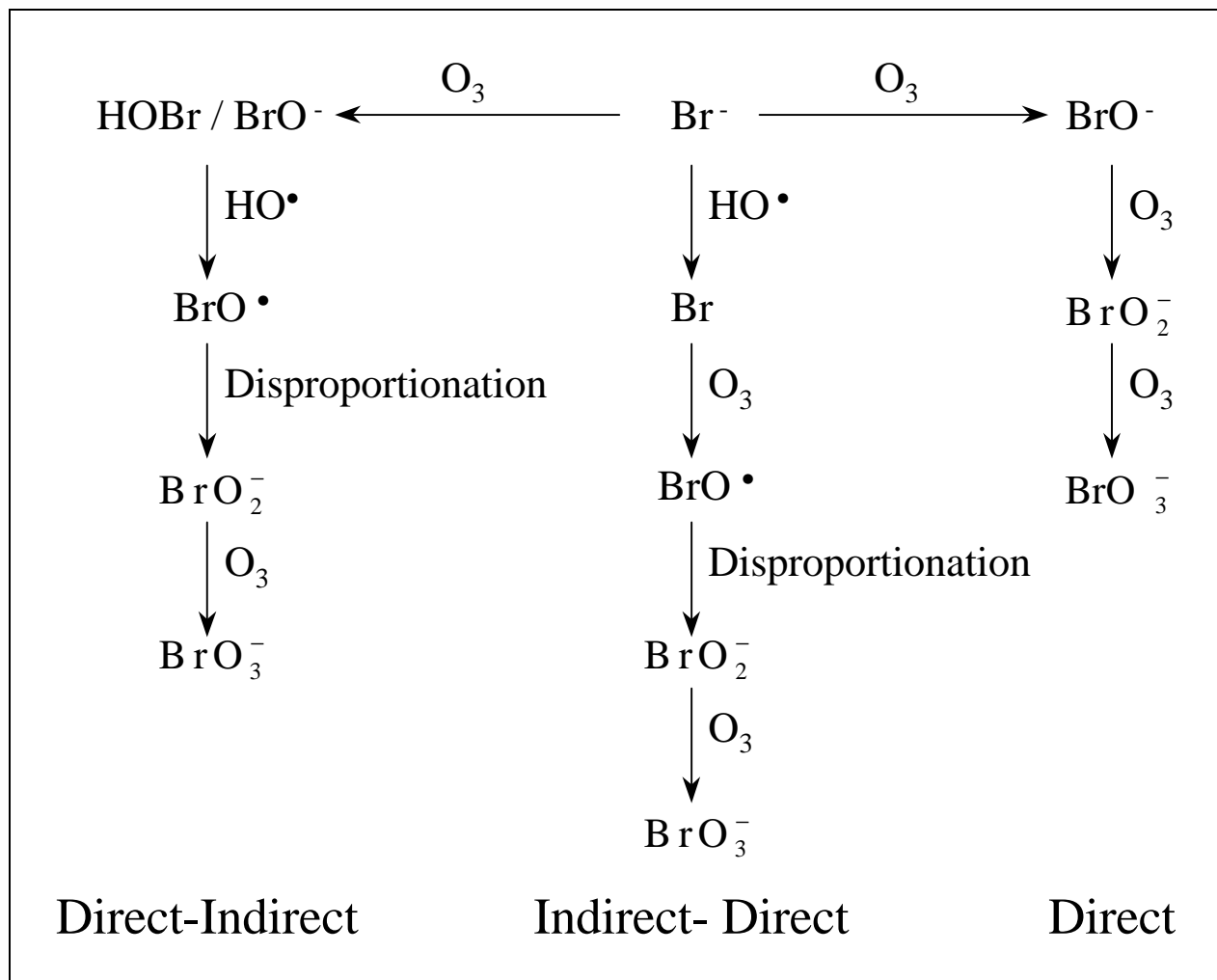
**Figure 3-11. Principal Reactions Producing Ozone Byproducts**

Application of a secondary disinfectant following ozonation requires special consideration for potential interaction between disinfectants. For example, chloral hydrate formation has been

observed when using chlorine as a secondary disinfectant with ozone (McKnight and Reckhow, 1992; Logsdon et al., 1992). The ozonation byproduct of acetaldehyde is a known precursor for chloral hydrate, a byproduct of chlorination. Enhancement of chloral hydrate has not been observed when monochloramine is applied as the secondary disinfectant, or if biologically active filtration is used following ozonation and prior to chlorination (Singer, 1992). Chloropicrin formation from free chlorine appears to be enhanced by pre-ozonation (Hoigné and Bader, 1988) in the absence of biologically active filtration prior to addition of chlorine.

Byproducts such as aldehydes, ketones, acids, and others will be formed upon ozonation of water. The primary aldehydes that have been measured are: formaldehyde, acetaldehyde, glyoxal, and methyl glyoxal (Glaze et al., 1991). Total aldehyde concentration in drinking water disinfected with ozone range from less than 5 µg/L to 300 µg/L, depending on the TOC concentration and the applied ozone to organic carbon ratio (Van Hoof et al., 1985; Yamada and Somiya, 1989; Glaze et al., 1989a; Krasner et al., 1989; Glaze et al., 1991; LeLacheur et al., 1991). Aldehydes with higher molecular weights have also been reported (Glaze et al., 1989b). Other organic byproducts of ozonation are indicated in Table 3-9

Ozonation of a source water containing bromide ion can produce brominated byproducts, the brominated analogues of the chlorinated DBPs. Song et al. (1997) found that bromate ion formation is an important consideration for waters containing more than 0.10 mg/L bromide ion. These brominated byproducts include bromate ion, bromoform, the brominated acetic acids and acetonitriles, bromopicrin, and cyanogen bromide (if ammonia is present). An ozone dose of 2 mg/L produced 53 µg/L of bromoform and 17 µg/L of dibromoacetic acid in a water containing 2 mg/L of bromide ion (McGuire et al., 1990). Ozonation of the same water spiked with 2 mg/L bromide ion showed cyanogen bromide formation of 10 µg/L (McGuire et al., 1990). Furthermore, ozone may react with the hypobromite ion to form bromate ion (Amy and Siddiqui, 1991; Krasner et al., 1993), a probable human carcinogen (Regli et al., 1992). Bromate ion concentrations in ozonated water up to 60 µg/L have been reported (Amy and Siddiqui, 1991; Krasner et al., 1993). Note that the amount of bromide ion incorporated into the measured DBPs accounts for only one-third of the total raw water bromide ion concentration. This indicates that other brominated DBPs exist that are not yet identified (Krasner et al., 1989; MWDSC and JMM, 1992). Figure 3-12 shows the major pathways for bromate ion formation.



Source: Song et al., 1997.

**Figure 3-12. Main Pathways of Bromate Ion Formation when Ozone Reacts with Bromide Ion**

### 3.4.1 Ozone Byproduct Control

The primary factors affecting the speciation and concentrations of brominated byproducts are pH and the ozone-to-bromide ion and TOC-to-bromide ion ratios (Singer, 1992). Bromate ion formation can be controlled by ozonation at acidic pH values of which hypobromous acid dominates over the now absent hypobromite ion (Haag and Hoigné, 1984; Amy and Siddiqui, 1991; Krasner et al., 1993). Conversely, under alkaline pH conditions, ozone can oxidize the hypobromous acid further to produce bromate ion. At low pH values, the brominated organic byproducts are favored, while at greater pH values, bromate ion formation is favored. Therefore, the application of ozone may be limited for source waters containing bromide ion. Bromate ion formation can be controlled by lowering the ambient bromide ion concentration, lowering the ozone residual, and lowering the ozonation pH. The addition of ammonia with ozonation to form bromamines reduces the formation of both bromate ion and organic byproducts (Amy and Siddiqui, 1991; MWDSC and JMM, 1992). However, ammonia can act as a nutrient for nitrifying bacteria.

The organic acid and aldehyde byproducts of ozonation discussed above appear to be readily biodegradable and are a component of the assimilable organic carbon (AOC) or biodegradable organic carbon (BDOC). Ozonation increases the BOM by oxidation. Therefore, if water disinfected with ozone is coupled with a biologically active process (i.e., biological active carbon), removal of these biodegradable byproducts can be reduced. The use of biologically active filters, maintained by discontinuing the application of a disinfectant to the filters, has been shown to successfully remove aldehydes and other compounds representing a portion of the BDOC in a water (Bablon et al., 1988; Rittman, 1990; Reckhow et al., 1992). See Section 3.3.4 for a detailed discussion on biological active filters.

A recent study has shown that bromate ion and brominated organics can be controlled during ozonation by the following techniques (Song et al., 1997):

- Low pH decreases bromate ion formation while increasing brominated organic formation;
- Ammonia addition with short ozone contact time decreases both bromate ion and brominated organic formation;
- Hydrogen peroxide decreases brominated organic formation and may increase or decrease bromate ion formation, depending on other water quality parameters; and
- Low ozone DOC ratio leads to low bromate ion and brominated organic formation.

## 3.5 Status of Analytical Methods

During operation of an ozonation system it is necessary to analyze for ozone in both the liquid and gas phase to determine the applied ozone dose, ozone transfer efficiency and (for primary disinfection) residual ozone level. The gas stream exiting the ozone generator is monitored for ozone content to determine the applied ozone dose. The off-gas exiting the ozone contactor is monitored to determine the amount of ozone transferred to the liquid phase in the contactor and to calculate the ozone transfer efficiency. The disinfected water exiting the ozone contactor is monitored for residual ozone to ensure that CT values are met.

In addition, the ambient air in any ozone generating or handling room and ozone destruct off-gas are monitored for ozone concentration to protect workers in the event of leakages or destruct system failure.

### 3.5.1 Monitoring of Gas Phase Ozone

Points in an ozone treatment system where gas-phase ozone is monitored include:

- Ozone generator output;
- Contactor off-gas;
- Ozone destruct off-gas; and

- Ambient air in ozone process areas.

The range of ozone concentrations to be measured in the gas phase varies from less than 0.1 ppm by volume ( $0.2 \text{ mg/m}^3 \text{ NTP}$ ) in ambient air and ozone destruct off-gas, to 1 to 2 percent ( $10 \text{ g/m}^3 \text{ NTP}$ ) in contactor off-gas, to as high as 15 percent by weight ( $200 \text{ g/m}^3 \text{ NTP}$ ) in the ozone generator output.

Analytical methods for monitoring gas-phase ozone include:

- UV absorption;
- Iodometric methods;
- Chemiluminescence; and
- Gas-Phase titration.

Table 3-10 presents the working range, expected accuracy and precision, operator skill level required, interferences, and current status for gas phase ozone analysis.

#### **3.5.1.1 UV Absorption**

Gaseous ozone absorbs light in the short UV wavelength region with a maximum absorbance at 253.7 nm (Gordon et al., 1992). Instruments for measuring ozone by the absorption of UV radiation are supplied by several manufacturers for gas concentrations below 0.5 ppm by volume ( $1 \text{ g/m}^3 \text{ NTP}$ ). In general, these instruments measure the amount of light absorptions when no ozone is present and the amount of light absorptions when ozone is present. The meter output is the difference of the two readings, which is directly related to the actual amount of ozone present. The International Ozone Association (IOA) has accepted this procedure (IOA, 1989).

**Table 3-10. Characteristics and Comparisons of Gas-Phase Ozone Analytical Methods**

Type of Test	Working Range (mg/L)	Expected Accuracy (± %)	Expected Precision (± %)	Skill Level <sup>a</sup>	Interferences	pH Range	Field Test	Automated Test	Current Status
UV Absorption	0.5 - 50,000	2	2.5	1/2	None	NA	Yes	Yes	Recommended
Stripping Absorption Iodometry	0.5 - 100	1 - 35	1 - 2	2	SO <sub>2</sub> , NO <sub>2</sub>	NA	Yes	No	Not Recommended
Chemiluminescence	0.005 - 1	7	5	1/2	None	NA	Yes	Yes	Recommended
Gas-Phase Titration	0.005 - 30	8	8.5	2	None	NA	Yes	No	Not Recommended

Source: Gordon et al., 1992.

Notes: <sup>a</sup> Operator Skill Levels: 1 = minimal, 2 = good technician, 3 = experienced chemist. NA = Not Applicable

### **3.5.1.2 Iodometric Methods**

Iodometric procedures have been used for all of the ozone concentration ranges encountered in water treatment plants (Gordon et al., 1992). This includes measurement of ozone directly from the generator and of ozone as stripped from aqueous solution. For the iodometric method, the ozone-containing gas is passed into an aqueous solution containing excess potassium iodide.

All other oxidizing materials act as interferences with iodometry (Gordon et al., 1992). Nitrogen oxides (that may be present when ozone is generated in air) also act as interferences to iodometric methods. The effects of nitrogen oxides may be eliminated by passing the ozone-containing gas through absorbents such as potassium permanganate that are specific for nitrogen oxide gases. However, no iodometric method is recommended for the determination of ozone in solution because of the unreliability of the method (Gordon et al., 1989).

### **3.5.1.3 Chemiluminescence**

Chemiluminescence methods can be used for the determination of low concentrations of ozone in the gas phase (Gordon et al., 1992). One of the most commonly used methods is ethylene chemiluminescence. Gas-phase ozone can be measured using the chemiluminescent reaction between ethylene and ozone. This method is specific to ozone and is suitable for measurement of ozone in the ambient air. The ethylene chemiluminescence procedure was adopted in 1985 by the EPA as its reference method for determining ozone in the ambient atmosphere (McKee et al., 1975). Chemiluminescent instruments are approved by the EPA for monitoring ambient ozone concentrations of 0 to 0.5 or 0 to 1.0 ppm by volume. With regular calibration, this type of instrument is capable of providing reliable analysis of any ozone in the ambient air from an ozonation plant.

An alternative to ethylene chemiluminescence is rhodamine B/gallic acid chemiluminescence, which avoids the handling of ethylene (Gordon et al., 1992). This alternative method is considerably more complex than the more common ethylene chemiluminescence instruments. The sensitivity of this method tends to drift and a procedure has been developed by which corrections are made for the sensitivity on a frequent basis (Van Dijk and Falkenberg, 1977). Given the wide availability of ethylene chemiluminescence monitors and their approval by EPA, ethylene monitors should be considered before rhodamine B/gallic acid monitors.

### **3.5.1.4 Gas-Phase Titration**

Two gas-phase titration methods have been studied as possible calibration methods for ambient ozone analyzers and monitors (Gordon et al., 1992). These procedures are based on titration with nitric oxide and back titration of excess nitric oxide (Rehme et al., 1980). These gas phase titration procedures, evaluated by EPA, were compared with UV absorption and iodometry as calibration methods for ethylene chemiluminescent ambient air ozone analyzers. As a result of these comparisons, UV absorption has been specified as the method of calibration for ambient ozone

analyzers. Therefore, gas-phase titration methods are not recommended for use at ozonation facilities (Gordon et al., 1992).

### 3.5.2 Monitoring of Liquid Phase Residual Ozone

There are numerous methods for monitoring ozone in aqueous solutions. Gordon et al. (1992) recommended the following methods for analyzing residual ozone:

- Indigo colorimetric method;
- Acid chrome violet K (ACVK) method;
- Bis-(Terpyridine) iron(II) method; and
- Stripping into the gas-phase.

Table 3-11 shows the working range, expected accuracy and precision, operator skill level required, interferences and current status for liquid phase residual ozone analytical methods.

#### 3.5.2.1 Indigo Colorimetric Method

The indigo colorimetric method is the only method for monitoring residual ozone in *Standard Methods*, 1995. The indigo colorimetric method is sensitive, precise, fast, and more selective for ozone than other methods. There are two indigo colorimetric methods: spectrophotometric and visual. For the spectrophotometric procedure the lower limit of detection is 2 µg/L, while for the visual procedure the detection limit is 10 µg/L.

Hydrogen peroxide, chlorine, manganese ions, ozone decomposition products, and the products of organic ozonation exhibit less interference with the indigo colorimetric method than any of the other methods (Langlais et al., 1991). However, the masking of chlorine in the presence of ozone can make the indigo method problematic. In the presence of hypobromous acid, which forms during ozonation of bromide-ion containing methods, an accurate measurement cannot be made with this method (Standard Methods, 1995).

**Table 3-11. Characteristics and Comparisons of Residual Ozone Analytical Methods**

Type of Test	Working Range (mg/L)	Expected Accuracy (± %)	Expected Precision (± %)	Skill Level <sup>a</sup>	Interferences	pH Range	Field Test	Automated Test	Current Status
Indigo Colorimetric, Spectrophotometric	0.01 - > 0.3	1	0.5	1	Chlorine, Manganese ions, Bromine, Iodine	2	No	Yes	Recommended
Indigo Colorimetric, Visual	0.01 - > 0.1	1	0.5	1	Chlorine, Manganese ions, Bromine, Iodine	2	No	Yes	Recommended
ACVK	0.05 - 1	NR	NR	1	Manganese ions > 1 mg/L, Chlorine > 10 mg/L	2	No	No	Recommended
Bis-(Terpyridine) Iron(II)	0.05 - 20	2.7	2.1	3	Chlorine	< 7	No	Yes	Recommended Lab Test

Source: Gordon et al., 1992.

Notes: <sup>a</sup> Operator Skill Levels: 1 = minimal, 2 = good technician, 3 = experienced chemist. NR = Not reported in literature cited by referenced source.

### 3.5.2.2 ACVK Method

ACVK is readily bleached by ozone, which serves as the basis for this spectrophotometric procedure first reported by Masschelein (1977). The procedure has been developed further for the measurement of ozone in the presence of chlorine (Ward and Larder, 1973).

The advantages of this method (Langlais et al., 1991) are:

- Its ease of execution and stability of the dye reagent solution;
- A linear calibration curve over the range of 0.05 to 1.0 mg/L of ozone; and
- The apparent lack of interferences from low levels of manganese, chlorine or combined chlorine (up to 10 mg/L), organic peroxides, and other organic oxidation products.

### 3.5.2.3 Bis-(Terpyridine)Iron(II) Method

Bis-(Terpyridine)Iron(II) in dilute hydrochloric acid solution reacts with ozone to change the absorbance spectra measured at 552 nm (Tomiyasu and Gordon, 1984). The only known interferent is chlorine. However, chlorine interferences can be masked by the addition of malonic acid. Alternatively, since the reaction between chlorine and the reagent is slower than the reaction with ozone, the spectrophotometric measurements can be carried out immediately after reagent mixing to reduce the chlorine interference. Chlorine dioxide does not interfere (Gordon et al, 1992).

The primary advantages of the Bis-(Terpyridine)Iron(II) Method are its lack of interferences, low limits of detection (4 µg/L), broad working range (up to 20 mg/L), excellent reproducibility, and agreement with the indigo colorimetric method.

### 3.5.2.4 Stripping into the Gas-Phase

In this indirect procedure, residual ozone is stripped from the solution using an inert gas. The amount of ozone present in the gas phase is then analyzed by gas-phase analytical methods such as UV absorption or chemiluminescence described previously. This stripping technique was developed to minimize the complications caused by the presence of other oxidants in solution.

The success of this procedure initially depends upon the ability to strip ozone from the treated water without any decomposition. Since stripping conditions such as temperature, pH, and salinity can vary, the reliability of this method is suspect (Langlais et al., 1991).

## 3.5.3 Bromate Monitoring for Systems Using Ozone

The DBPR requires that community water systems and non-transient non-community water systems that use ozone for disinfection or oxidation must monitor their system for bromate. These systems are required to take one sample per month for each treatment plant with samples collected at the entrance to the distribution system while the ozonation system is operating under normal conditions.

The DBPR provides reduced monitoring opportunities (i.e., quarterly rather than monthly samples) if the system demonstrates that the average source water bromide concentration is less than 0.05 mg/L based upon representative monthly bromide measurements for one year. Systems can remain on the reduced monitoring schedule until the running annual average source water bromide concentration, computed quarterly, is equal to or greater than 0.05 mg/L based upon representative monthly measurements.

For compliance monitoring for bromate, systems must use the ion chromatography analytical method as specified in *USEPA Method 300.1, Determination of Inorganic Anions in Drinking Water by Ion Chromatography, Revision 1.0* (USEPA, 1997).

If the average of samples covering any consecutive four-quarter period exceeds the MCL, the system is in violation of the MCL and must notify the public pursuant to 40 CFR §141.32. The system must also report to the State pursuant to 40 CFR §141.134. If the system fails to complete 12 consecutive months' monitoring, compliance with the MCL for the last four-quarter compliance period must be based on an average of the available data.

## 3.6 Operational Considerations

### 3.6.1 Process Considerations

Because ozone is such a strong oxidant, it will react with many organic and inorganic compounds present in the water. Ozone is used to remove tastes and odors by breaking down organic compounds, and to aid in the removal of iron and manganese by oxidizing these compounds to less soluble forms. These demands should be satisfied before any ozone is available to satisfy primary disinfection requirements. The presence and concentration of these compounds can dictate the location of ozone addition, depending on the process goals.

Stolarik and Christie (1997) present the results of 10 years of operation at the 600 mgd Los Angeles Aqueduct Filtration and Ozone Facility. Operational experiences at this facility showed lower particle counts (greater than one micron) with ozone use. The optimum ozone concentration in the gas phase applied was found to be 6 percent when using the cryogenic oxygen production facilities, and 4 to 5 percent when using liquid oxygen (LOX).

### 3.6.2 Space Requirements

Storage of LOX is subject to regulations in building and fire codes. These regulations will impact the space requirements and may dictate the construction materials of adjacent structures if the certain setback requirements cannot be met. In general, the footprint for ozone generated from air is smaller than that required for chloramination and chloride dioxide applications. However, the footprint area for ozone generated from pure oxygen is comparable to that of chlorine dioxide because of the additional area needed for storage.

### 3.6.3 Material Selection

Ozone-resistant materials should be used from the ozone generators through the off-gas destruct unit. If oxygen is used for the feed gas, oxygen resistant materials should be used up to the generators. Pure oxygen piping should be specially cleaned after installation for oxygen service, which increases construction cost. Materials for air preparation systems can be those normally used for compressed air systems. Langlais et al. (1991) recommended that piping beyond the desiccant dryers be ozone-resistant, as some backflow and ozone diffusion can occur. If a receiver is provided following the desiccant dryer, the piping should be ozone-resistant, downstream of the pressure regulator. Ozone-resistant (oxygen resistant as well if high purity oxygen is the feed gas) check valves should be placed in the piping ahead of the generator.

Ozone-resistant materials include the austenitic (300 series) stainless steels, glass and other ceramics, Teflon and Hypalon, and concrete. The 304 series stainless steels can be used for “dry” ozone gas (also for oxygen), 316 series should be used for “wet” service. Wet service includes piping in the contactors and all off-gas piping and the off-gas destruct unit. Teflon or Hypalon should be used for gasket materials. Concrete should be manufactured from Type II or Type IV cement. Typical practice in the United States is to provide 3 inches of cover for reinforcing to prevent corrosion by either ozone gas or ozone in solution, although Fonlupt (1979) reports that 4 cm (1.13 inches) is adequate for protection. Hatches for access into contactors should be fabricated from 316 series stainless steels and provided with ozone-resistant seals.

### 3.6.4 Ozone System Maintenance

Stolarik and Christie (1997) provide a good overview of the operational and maintenance requirements during the 10 years of operating the 600 mgd Los Angeles Aqueduct Filtration and Ozone Plant. The ozone system has been available 97.1 percent of the time over the 10 year period.

Fuse failure and generator cleaning comprised the major maintenance chores on the ozone generators during the first years. Fuse failure was caused by a malfunction when its glass dielectric tube failed. Vessels are cleaned every three years or when exit gas temperatures rise due to  $\text{Fe}_3\text{O}_4$  deposits on the ground electrode/heat exchanger surfaces.

Rod shaped ceramic diffusers worked well as ozone diffusers for the initial two years. These were replaced by sintered stainless steel and ultimately a modified ceramic diffuser.

### 3.6.5 Ozone Safety

Concern for safety even at the risk of being overcautious, would be to follow practices that have been successfully applied to other oxidants over the years. This would be to generally isolate the ozonation system from the remainder of the plant. This should not be interpreted to mean a separate building, but rather separate rooms, separate exterior entrances, separate heating and ventilation systems, noise control, etc. This method already is manifested in some of the European ozonation plants, but on a lesser scale.

Ozone generators should be housed indoors for protection from the environment and to protect personnel from leaking ozone in the case of a malfunction. Ventilation should be provided to prevent excess temperature rise in the generator room, and to exhaust the room in the case of a leak.

Adequate space should be provided to remove the tubes from the generator shell and to service the generator power supplies. Air prep systems tend to be noisy; therefore, it is desirable to separate them from the ozone generators. Off-gas destruct units can be located outside if the climate is not too extreme. If placed inside, an ambient ozone detector should be provided in the enclosure. All rooms should be properly ventilated, heated, and cooled to match the equipment-operating environment.

Continuous monitoring instruments should be maintained to monitor levels of ozone in the rooms. Self-contained breathing apparatuses should be located in hallways outside the rooms liable to ozone hazards. Ambient ozone exposure levels, which have been proposed by appropriate U.S. organizations, are summarized below. The maximum recommended ozone levels are as follows:

- **Occupational Safety and Health Administration.** The maximum permissible exposure to airborne concentrations of ozone not in excess of 0.1 mg/L (by volume) averaged over an eight-hour work shift.
- **American National Standards Institute/American Society for testing Materials (ANSI/ASTM).** Control occupational exposure such that the worker will not be exposed to ozone concentrations in excess of a time weighted average of 0.1 mg/L (by volume) for eight hours or more per workday, and that no worker be exposed to a ceiling concentration of ozone in excess of 0.3 mg/L (by volume) for more than ten minutes.
- **American Conference of Government Industrial Hygienists (ACGIH).** Maximum ozone level of 0.1 mg/L (by volume) for a normal eight hour work day or 40 hour work week, and a maximum concentration of 0.3 mg/L (by volume) for exposure of up to 15 minutes.
- **American Industrial Hygiene Association.** Maximum, concentration for eight hour exposure of 0.1 mg/L (by volume).

There is a question of whether prolonged exposure to ozone may impair a worker's ability to smell or be aware of ozone levels at less than critical levels. Awareness of an odor of ozone should not be relied upon. Instrumentation and equipment should be provided to measure ambient ozone levels and perform the following safety functions:

- Initiate an alarm signal at an ambient ozone level of 0.1 mg/L (by volume). Alarms should include warning lights in the main control panel and at entrances to the ozonation facilities as well as audible alarms.
- Initiate a second alarm signal at ambient ozone levels of 0.3 mg/L (by volume). This signal would immediately shut down ozone generation equipment and would initiate a second set of visual and audible alarms at the control panel and at the ozone generation facility entrances. An

emergency ventilation system capable of exhausting the room within a period of 2 to 3 minutes also would be interconnected to the 0.3 mg/L ozone level alarm.

Ozone gas is a hazardous gas and should be handled accordingly. Ambient ozone levels should be monitored and equipment shut-down and alarmed when levels exceed 0.1 ppm. Emergency ventilation is typically provided for enclosed areas. Building and fire codes will provide additional guidance. The OSHA exposure limit for an 8-hour shift is 0.1 ppm by volume. The pungent odor of ozone will provide warning to operators of any possible ozone leak.

## 3.7 Summary

### 3.7.1 Advantages and Disadvantages of Ozone Use

The following list highlights selected advantages and disadvantages of using ozone as a disinfection method for drinking water (Masschelein, 1992). Because of the wide variation of system size, water quality, and dosages applied, some of these advantages and disadvantages may not apply to a particular system.

#### Advantages

- Ozone is more effective than chlorine, chloramines, and chlorine dioxide for inactivation of viruses, *Cryptosporidium*, and *Giardia*.
- Ozone oxidizes iron, manganese, and sulfides.
- Ozone can sometimes enhance the clarification process and turbidity removal.
- Ozone controls color, taste, and odors.
- One of the most efficient chemical disinfectants, ozone requires a very short contact time.
- In the absence of bromide, halogen-substituted DBPs are not formed.
- Upon decomposition, the only residual is dissolved oxygen.
- Biocidal activity is not influenced by pH.

#### Disadvantages

- DBPs are formed, particularly by bromate and bromine-substituted DBPs, in the presence of bromide, aldehydes, ketones, etc.
- The initial cost of ozonation equipment is high.
- The generation of ozone requires high energy and should be generated on-site.
- Ozone is highly corrosive and toxic.
- Biologically activated filters are needed for removing assimilable organic carbon and biodegradable DBPs.
- Ozone decays rapidly at high pH and warm temperatures.
- Ozone provides no residual.

- Ozone requires higher level of maintenance and operator skill.

### 3.7.2 Summary Table

Table 3-12 presents a summary of the considerations for the use of ozone as a disinfectant.

**Table 3-12. Summary of Ozone Disinfection Considerations**

Consideration	Description
Generation	Because of its instability, ozone should be generated at the point of use. Ozone can be generated from oxygen present in air or high purity oxygen. The feed gas source should be clean and dry, with a maximum dewpoint of $-60^{\circ}\text{C}$ . Ozone generation consumes power at a rate of 8 to 17 kWhr/kg $\text{O}_3$ . Onsite generation saves a lot of storage space.
Primary uses	Primary uses include primary disinfection and chemical oxidation. As an oxidizing agent, ozone can be used to increase the biodegradability of organic compounds destroys taste and odor control, and reduce levels of chlorination DBP precursors. Ozone should not be used for secondary disinfection because it is highly reactive and does not maintain an appreciable residual level for the length of time desired in the distribution system.
Inactivation efficiency	Ozone is one of the most potent and effective germicide used in water treatment. It is effective against bacteria, viruses, and protozoan cysts. Inactivation efficiency for bacteria and viruses is not affected by pH; at pH levels between 6 and 9. As water temperature increases, ozone disinfection efficiency increases.
Byproduct formation	Ozone itself does not form halogenated DBPs; however, if bromide ion is present in the raw water or if chlorine is added as a secondary disinfectant, halogenated DBPs, including bromate ion may be formed. Other ozonation byproducts include organic acids and aldehydes.
Limitations	Ozone generation is a relatively complex process. Storage of LOX (if oxygen is to be the feed gas) is subject to building and fire codes.
Points of application	For primary disinfection, ozone addition should be prior to biofiltration/filtration and after sedimentation. For oxidation, ozone addition can be prior to coagulation/sedimentation or filtration depending on the constituents to be oxidized.
Safety considerations	Ozone is a toxic gas and the ozone production and application facilities should be designed to generate, apply, and control this gas, so as to protect plant personnel. Ambient ozone levels in plant facilities should be monitored continuously.

## 3.8 References

1. Alceon Corp. 1993. Overview of Available Information on the Toxicity of Drinking Water Disinfectants and Their By-products. Cambridge, MA.
2. Amy, G.L., M.S. Siddiqui. 1991. "Ozone-Bromide Interactions in Water Treatment." Conference proceedings, AWWA Annual Conference, Philadelphia, PA.
3. AWWA (American Water Works Association). 1990. *Water Quality and Treatment*. F.W. Pontius (editor), McGraw-Hill, New York, NY.
4. Bablon, G.P., C. Ventresque, R.B. Aim. 1988. "Developing a Sand-GAC Filter to Achieve High Rate Biological Filtration." *J. AWWA*.80(12):47.
5. Bablon, G., et al. 1991. "Practical Application of Ozone: Principles and Case Studies." *Ozone in Water Treatment Application and Engineering*. AWWARF.
6. Billen, G., et al. 1985. Action des Populations Bactériennes Vis-à-Vis des Matières Organiques dans les Filtres Biologiques. Report to Compagnie Générale des Eaux, Paris.
7. Boyce, D.S., et al. 1981. "The Effect of Bentonite Clay on Ozone Disinfection of Bacteria and Viruses in Water." *Water Res.* 15:759-767.
8. Bringmann, G. 1954. "Determination of the Lethal Activity of Chlorine and Ozone on *E. coli*." *Z. f., Hygiene.* 139:130-139.
9. Chang, S.L. 1971. "Modern Concept of Disinfection." *J. Sanit. Engin. Division.* 97:689-707.
10. Cronholm, L.S., et al. 1976. "Enteric Virus Survival in Package Plants and the Upgrading of the Small Treatment Plants Using Ozone." Research Report No. 98, Water Resources Research Institute, University of Kentucky, Lexington, KY.
11. DeMers, L.D. and R.C. Renner. 1992. *Alternative Disinfection Technologies for Small Drinking Water Systems*. AWWARF and AWWA, Denver, CO.
12. Dimitriou, M.A. (editor). 1990. *Design Guidance Manual for Ozone Systems*. International Ozone Association, Norwalk, CN.
13. Domingue, E. L., et al. 1988. "Effects of Three Oxidizing Biocides on *Legionella pneumophila*, Serogroup 1." *Appl. Environ. Microbiol.* 40:11-30.
14. Eighmy, T.T., S.K. Spanos, J. Royce, M.R. Collins, J.P. Malley. 1991. "Microbial Activity in Slow Sand Filters." Conference proceedings, Slow Sand Filtration Workshop, Timeless Technology for Modern Applications, Durham, NH.

15. Farooq, S. et al. 1977. "The Effect of Ozone Bubbles on Disinfection." *Progr. Water Ozone Sci. Eng.* 9(2):233.
16. Farooq, S. 1976. *Kinetics of Inactivation of Yeasts and Acid-Fast Organisms with Ozone*. Ph.D. Thesis, University of Illinois at Urbana-Champaign, IL.
17. Farvardin, M.R. and A.G. Collins. 1990. "Mechanism(s) of Ozone Induced Coagulation of Organic Colloids." Conference proceedings, AWWA Annual Conference, Cincinnati, OH.
18. Finch, G. R., E.K. Black, and L.L. Gyürék. 1994. "Ozone and Chlorine Inactivation of *Cryptosporidium*." Conference proceedings, Water Quality Technology Conference, Part II, San Francisco, CA.
19. Franson, M.H., Eaton, A.D., Clesceri, L.S., and Greenberg, A.E., (editors). 1995. *Standard Methods for the Examination of Water and Wastewater, Nineteenth Edition*. American Public Health Association, AWWA, and Water Environment Federation, Washington D.C.
20. Georgeson, D.L. and A.A. Karimi. 1988. "Water Quality Improvements with the Use of Ozone at the Los Angeles Water Treatment Plant." *Ozone Sci. Engrg.* 10(3):255-276.
21. Giese, A.C. and E. Christensen. 1954. "Effects of Ozone on Organisms." *Physiol. Zool.* 27:101.
22. Glaze W.H., M. Koga, D. Cancilla. 1989a. "Ozonation Byproducts. 2. Improvement of an Aqueous-Phase Derivatization Method for the Detection of Formaldehyde and Other Carbonyl Compounds Formed by the Ozonation of Drinking Water." *Environ. Sci. Technol.* 23(7):838.
23. Glaze, W.H., M. Koga M., D. Cancilla, et al. 1989b. "Evaluation of Ozonation Byproducts from Two California Surface Waters." *J. AWWA.* 1(8):66.
24. Glaze, W.H., et al. 1987. "The Chemistry of Water Treatment Processes Involving Ozone, Hydrogen Peroxide, and Ultraviolet Radiation." *Ozone Sci. Engrg.* 9(4):335.
25. Glaze, W.H., and J.W. Kang. 1988. "Advanced Oxidation Processes for Treating Groundwater Contaminated with TCE and PCE: Laboratory Studies." *J. AWWA.* 88(5):57- 63.
26. Glaze, W.H., H.S. Weinberg, S.W. Krasner, M.J. Sclimenti. 1991. "Trends in Aldehyde Formation and Removal Through Plants Using Ozonation and Biological Active Filters." Conference proceedings, AWWA, Philadelphia, PA.
27. Goldstein, B.D., and E.M. McDonagh. 1975. "Effect of Ozone on Cell Membrane Protein Fluorescence I. *in vitro* Studies Utilizing the Red Cell Membrane." *Environ. Res.* 9:179-186.
28. Gordon, G. K. Rankness, D. Vornehm, and D. Wood. 1989. "Limitations of the Iodometric Determination of Ozone." *J. AWWA.* 81(6):72-76.
29. Gordon, G., W.J. Cooper, R.G. Rice, and G.E. Pacey. 1992. *Disinfectant Residual Measurement Methods*, second edition. AWWARF and AWWA, Denver, CO.

30. Gurol, M.D. and M. Pidotella. 1983. "A Study of Ozone-Induced Coagulation." Conference proceedings, ASCE Environmental Engineering Division Specialty Conference. Allen Medine and Michael Anderson (editors), Boulder, CO.
31. Haag, W.R. and J. Hoigné. 1984. "Kinetics and Products of the Reactions of Ozone with Various Forms of Chlorine and Bromine in Water." *Ozone Sci. Engrg.* 6(2):103-14.
32. Hann, V.A. 1956. "Disinfection of Drinking Water with Ozone." *J. AWWA.* 48(10):1316.
33. Harakeh, M.S. and M. Butler. 1984. "Factors Influencing the Ozone Inactivation of Enteric Viruses in Effluent." *Ozone Sci. Engrg.* 6:235-243.
34. Hildebrand, D.J., A.F. Hess, P.B. Galant, and C.R. O'Melia. 1986. "Impact of Chlorine Dioxide and Ozone Preoxidation on Conventional Treatment and Direct Filtration Treatment Processes." Conference proceedings, AWWA Seminar on Ozonation: Recent Advances and Research Needs, Denver, CO.
35. Hoff, J.C. 1986. *Inactivation of Microbial Agents by Chemical Disinfectants*, U. S. Environmental Protection Agency, EPA/600/2-86/067.
36. Hoigné J. and H. Bader. 1976. Role of Hydroxyl Radical Reactions in Ozonation Processes in Aqueous Solutions, *Water Res.* 10: 377.
37. Hoigné J., and H. Bader. 1988. "The Formation of Trichloronitromethane (chloropicrin) and Chloroform in a Combined Ozonation/Chlorination Treatment of Drinking Water." *Water Res.* 22(3):313.
38. Hoigné J., and H. Bader. 1983b. "Rate Constants of Reaction of Ozone with Organic and Inorganic Compounds in Water - II. Dissociating Organic Compounds." *Water Res.* 17:185-194.
39. Hoigné J., and H. Bader. 1977. "The Role of Hydroxyl Radical Reactions in Ozonation Processes in Aqueous Solutions." *Water Res.* 10:377-386.
40. Hoigné J., and H. Bader. 1983a. "Rate Constants of Reaction of Ozone with Organic and Inorganic Compounds in Water - I. Non-dissociating Organic Compounds." *Water Res.* 17:173-183.
41. Hoigné, J. and Bader, H. 1975. Ozonation of Water: Role of Hydroxyl Radicals as Oxidizing Intermediates. *Science*, Vol. 190, pp. 782.
42. Huck, P.M., P.M. Fedorak, and W.B. Anderson. 1991. "Formation and Removal of Assimilable Organic Carbon During Biological Treatment." *J. AWWA.* 83(12):69-80.
43. IOA (International Ozone Association). 1989. *Photometric Measurement of Low Ozone Concentrations in the Gas Phase*. Standardisation Committee--Europe.

44. Katz, J. 1980. *Ozone and Chlorine Dioxide Technology for Disinfection of Drinking Water*. Noyes Data Corporation, Park Ridge, New Jersey.
45. Katzenelson, E., et al. 1974. "Inactivation Kinetics of Viruses and Bacteria in Water by Use of Ozone." *J. AWWA*. 66:725-729.
46. Keller, J.W., R.A. Morin, and T.J. Schaffernoth. 1974. "Ozone Disinfection Pilot Plants Studies at Laconia, New Hampshire." *J. AWWA*. 66:730.
47. Kim, C.K., et al. 1980. "Mechanism of Ozone Inactivation of Bacteriophage f2." *Appl. Environ. Microbiol.* 39:210-218.
48. Kinman, R.N. 1975. "Water and Wastewater Disinfection with Ozone: A Critical Review." *Crit. Rev. Environ. Contr.* 5:141-152.
49. Krasner, S.W., W.H. Glaze, H.S. Weinberg, et al. 1993. "Formation and Control of Bromate During Ozonation of Water Containing Bromide." *J. AWWA*. 85(5):62..
50. Krasner, S.W., et al. 1989. "The Occurrence of Disinfection By-products in US Drinking Water." *J. AWWA*. 81(8):41.
51. Langlais, B., et al. 1990. "New Developments: Ozone in Water and Wastewater Treatment. The CT Value Concept for Evaluation of Disinfection Process Efficiency; Particular Case of Ozonation for Inactivation of Some Protozoa, Free-Living Amoeba and *Cryptosporidium*." Presented at the Int. Ozone Assn. Pan-American Conference, Shreveport, Louisiana, March 27-29.
52. Langlais, B., D.A. Reckhow, and D.R. Brink (editors). 1991. *Ozone in Drinking Water Treatment: Application and Engineering*. AWWARF and Lewis Publishers, Boca Raton, FL.
53. Langlais B. and D. Perrine. 1986. "Action of Ozone on Trophozoites and Free Amoeba Cysts, Whether Pathogenic or Not." *Ozone Sci. Engrg.* 8(3):187-198.
54. LeChevallier, M.W., W.C. Becker, P. Schorr, and R.G. Lee. 1992. "Evaluating the Performance of Biologically Active Rapid Filters." *J. AWWA*. 84(4):136-146.
55. LeLacheur, R.M., P.C. Singer, and M.J. Charles. 1991. "Disinfection By-products in New Jersey Drinking Waters." Conference proceedings, AWWA Annual Conference, Philadelphia, PA.
56. Logsdon, G.S., S. Foellmi, and B. Long. 1992. "Filtration Pilot Plant Studies for Greater Vancouver's Water Supply." Conference proceedings, AWWA Annual Conference, Vancouver, British Columbia.
57. Malley, J.P., T.T. Eighmy, M.R. Collins, J.A. Royce, and D.F. Morgan. 1993. "The True Performance and Microbiology of Ozone - Enhanced Biological Filtration." *J. AWWA*. 85(12):47-57.

58. Masschelein, W.J. 1992. "Unit Processes in Drinking Water Treatment." Marcel Decker D.C., New York , Brussels, Hong Kong.
59. Masschelein, W.J. 1977. "Spectrophotometric Determination of Residual Ozone in Water with ACVK." *J. AWWA*. 69:461-462.
60. McGuire, M.J., S.W. Krasner, and J. Gramith. 1990. Comments on Bromide Levels in State Project Water and Impacts on Control of Disinfection Byproducts Metropolitan Water District of Southern California.
61. McKee, H.C., R.E. Childers, and V.B. Parr 1975. *Collaborative Study of Reference Method for Measurement of Photochemical Oxidants in the Atmosphere*, EPA EPA-650/4-75-016, Washington, D.C. February.
62. McKnight A., and D.A. Reckhow. 1992. "Reactions of Ozonation Byproducts with Chlorine and Chloramines." Conference proceedings, AWWA Annual Conference, Vancouver, British Columbia.
63. MWDSC and JMM (Metropolitan Water District of Southern California and James M. Montgomery Consulting Engineers). 1992. "Pilot Scale Evaluation of Ozone and peroxone." AWWARF and AWWA, Denver, CO.
64. Morris, J.C. 1975. "Aspects of the Quantitative Assessment of Germicidal Efficiency." *Disinfection: Water and Wastewater*. J.D. Johnson (editor). Ann Arbor Science Publishers, Inc., Ann Arbor, MI.
65. Owens, J. H., et al. 1994. "Pilot-Scale Ozone Inactivation of *Cryptosporidium* and *Giardia*." Conference proceedings, Water Quality Technology Conference, Part II, San Francisco, CA.
66. Peeters, J. E. et al. 1989. "Effect of Disinfection of Drinking Water with Ozone or Chlorine Dioxide on Survival of *Cryptosporidium parvum* Oocysts." *Appl. Environ. Microbiol.* 55(6):1519-1522.
67. Perrine, D., et al. 1984. "Action d l'Ozone sur les Trophozoites d'Amibes Libres Pathogens ou Non." *Bull Soc.Frnac. Parasitol.* 3:81.
68. Prendiville, D.A. 1986. "Ozonation at the 900 cfs Los Angeles Water Purification Plant." *Ozone Sci. Engrg.* 8:77.
69. Price, M.L. 1994. *Ozone and Biological Treatment for DBP Control and Biological Stability*. AWWARF and AWWA, Denver, CO, pp. 252.
70. Rachwal, A.J., et al. 1988. "Advanced Techniques for Upgrading Large Scale Slow Sand Filters." *Slow Sand Filtration- Recent Developments in Water Treatment Technology*, Ellis Horwood Ltd, Chichester, U.K.

71. Reckhow, D.A., J.K. Edzwald, and J.E. Tobiason. 1993. "Ozone as an Aid to Coagulation and Filtration." AWWARF and AWWA, Denver, CO.
72. Reckhow, D.A., P.C.Singer, and R.R. Trussell. 1986. Ozone as a coagulant aid. Seminar proceedings, Ozonation, Recent Advances and Research Needs, AWWA Annual Conference, Denver, CO.
73. Reckhow, D.A., J.E. Tobiason, M.S. Switzenbaum, R. McEnroe, Y. Xie, X. Zhou, P. McLaughlin, and H.J. Dunn. 1992. "Control of Disinfection Byproducts and AOC by Pre-Ozonation and Biologically Active In-Line Direct Filtration." Conference proceedings, AWWA Annual Conference, Vancouver, British Columbia.
74. Regli, S., J.E. Comwell, X. Zhang., et al. 1992. *Framework for Decision Making: An EPA Perspective*. EPA 811-R-92-005, EPA, Washington, D.C.
75. Rehme, K.A., J.C. Puzak, M.E. Beard, C.F. Smith, and R.J. Paur. 1980. *Evaluation of Ozone Calibration Procedures*, EPA-600/S4-80-050, EPA, Washington, D.C, February.
76. Renner, R.C., M.C. Robson, G.W. Miller, and A.G. Hill. 1988. "Ozone in Water Treatment - The Designer's Role." *Ozone Sci. Engrg.* 10(1):55-87.
77. Rice, R.G. 1996. Ozone Reference Guide. Electric Power Research Institute, St. Louis, MO.
78. Rice, R.G., P.K. Overbeck, K. Larson. 1998. Ozone Treatment for Small Water Systems. Presented at the First International Symposium on Safe Drinking water in Small Systems. NSF International/PAHP/WHO, Arlington, VA, May 10-13, 1998.
79. Riesser, V.W., et al. 1976. "Possible Mechanisms of Poliovirus Inactivation by Ozone." *Forum on Ozone Disinfection*, E. G. Fochtman, R.G. Rice, and M.E. Browning (editors), pp. 186-192, International Ozone Institute, Syracuse, NY.
80. Rittman, B.E. 1990. "Analyzing Biofilm Processes Used in Biological Filtration." *J. AWWA.* 82(12):62.
81. Roy, D. 1979. *Inactivation of Enteroviruses by Ozone*. Ph.D. Thesis, University of Illinois at Urbana-Champaign.
82. Roy, D., R.S. Engelbrecht, and E.S.K. Chian. 1982. "Comparative Inactivation of Six Enteroviruses by Ozone." *J. AWWA.* 74(12):660.
83. Scott, D.B.M. and E.C. Leshner. 1963. "Effect of Ozone on Survival and Permeability of Escherichia coli." *J. Bacteriol.* 85:567-576.
84. Singer P.C. 1992. "Formation and Characterization of Disinfection Byproducts." Presented at the First International Conference on the Safety of Water Disinfection: Balancing Chemical and Microbial Risks.

85. Singer, P.C., et al. 1989. "Ozonation at Belle Glade, Florida: A Case History." Conference proceeding, IOA Ninth Ozone World Conference.
86. Song, R., et al. 1997. "Bromate Minimization During Ozonation." *J. AWWA*. 89(6):69.
87. Sproul, O. J., et al. 1982. "The Mechanism of Ozone Inactivation of Waterborne Viruses." *Water Sci. Technol.* 14:303-314.
88. Staehelin, J., R.E. Bühler, and J. Hoigné. 1984. "Ozone Decomposition in Water Studies by Pulse Radiolysis. 2 OH and HO<sub>4</sub> as Chain Intermediates." *J. Phys. Chem.* 88:5999-6004.
89. Stolarik, G. F., and J.D. Christie. 1997. "A Decade of Ozonation in Los Angeles." Conference proceedings, IOA Pan American Group Conference, Lake Tahoe, NV.
90. Suffet, I.H., C. Anselme, and J. Mallevalle. 1986. "Removal of Tastes and Odors by Ozonation." Conference proceedings, AWWA Seminar on Ozonation: Recent Advances and Research Needs, Denver, CO.
91. Tobiason, J.E., J.K. Edzwald, O.D. Schneider, M.B. Fox, and H.J. Dunn. 1992. "Pilot Study of the Effects of Ozone and Peroxone on In-Line Direct Filtration." *J. AWWA*. 84(12):72-84.
92. Tomiyasu, H., and G. Gordon. 1984. "Colorimetric Determination of Ozone in Water Based on Reaction with Bis-(terpyridine)iron(II)." *Analytical Chem.* 56:752-754.
93. Troyan, J.J. and S.P. Hansen. 1989. *Treatment of Microbial Contaminants in Potable Water Supplies Technologies and Costs*. Noyes Data Corporation, Park Ridge, New Jersey.
94. Umphries, M.D., et al. 1979. "The Effects of Pre-ozonation on the Formation of Trihalomethanes." *Ozonews*. 6(3).
95. USEPA. 1997. USEPA Method 300.1, Determination of Inorganic Anions in Drinking Water by Ion Chromatography, Revision 1.0. EPA A/600/r-98/118.
96. Van Dijk, J.F.M., and R.A. Falkenberg. 1977. "The Determination of Ozone Using the Reaction with Rhodamine B/Gallic Acid." Presented at Third Ozone World Congress sponsored by the IOA, Paris, France, May.
97. Van Gunten, U. and J. Hoigné. 1996. "Ozonation of Bromide-Containing Waters: Bromate Formation through Ozone and Hydroxyl Radicals." *Disinfection By-Products in Water Treatment*, Minear, R.A. and G.L. Amy (editors). CRC Press, Inc., Boca Raton, FL.
98. Van Hoof, F., J.G. Janssens, H. van Dijck. 1985. "Formation of Mutagenic Activity During Surface Water Pre-ozonation and Its Removal in Drinking Water Treatment." *Chemosphere*, 14(5):501.

99. Vaughn, J.M., et al. 1987. "Inactivation of Human and Simian Rotaviruses by Ozone." *Appl. Env. Microbiol.* 53:2218-2221.
100. Walsh, D.S., et al. 1980. "Ozone Inactivation of Flocc Associated Viruses and Bacteria." *J. Environ. Eng. Div. ASCE.* 106:711-726.
101. Ward, S.B. and D.W. Larder. 1973. "The Determination of Ozone in the Presence of Chlorine." *Water Treatment Examination.* 22:222-229.
102. Wickramanayake, G.B., et al. 1984b. "Inactivation of Giardia lamblia Cysts with Ozone." *Appl. Env. Microbiol.* 48(3):671-672.
103. Wickramanayake, G.B., et al. 1984a. "Inactivation of Naegleria and Giardia cysts in Water by Ozonation." *J. Water Pollution Control Fed.* 56(8):983-988.
104. Wickramanayake, G.B. 1984c. *Kinetics and Mechanism of Ozone Inactivation of Protozoan Cysts.* Ph.D. dissertation, Ohio State University, Columbus, OH.
105. Wuhrmann, K., and J. Meyrath. 1955. "The Bactericidal Action of Ozone Solution. *Schweitz.*" *J. Allgen. Pathol. Bakteriol.*, 18:1060.
106. Yamada, H. and I. Somiya. 1989. "The Determination of Carbonyl Compounds in Ozonated Water By the PFBOA Method." *Ozone Sci. Engrg.* 11(2):127.
107. Zabel, T.F. 1985. "The Application of Ozone for Water Treatment in the United Kingdom - Current Practice and Recent Research." *Ozone Sci. Engrg.* 7(1):11.

<b>OZONE .....</b>	<b>3-1</b>
3.1 OZONE CHEMISTRY .....	3-1
3.2 OZONE GENERATION .....	3-4
3.2.1 Ozone Production .....	3-4
3.2.2 System Components .....	3-5
3.2.3 Operation and Maintenance .....	3-15
3.3 PRIMARY USES AND POINTS OF APPLICATION OF OZONE .....	3-16
3.3.1 Primary Uses of Ozone .....	3-16
3.3.2 Points of Application .....	3-18
3.3.3 Impact on Other Treatment Processes .....	3-19
3.3.4 Biologically Active Filtration .....	3-19
3.3.5 Pathogen Inactivation and Disinfection Efficacy .....	3-21
3.3.6 Inactivation Mechanisms .....	3-22
3.3.7 Disinfection Parameters .....	3-22
3.3.8 Inactivation of Microorganisms .....	3-24
3.4 OZONATION DISINFECTION BYPRODUCTS .....	3-27
3.4.1 Ozone Byproduct Control .....	3-30
3.5 STATUS OF ANALYTICAL METHODS .....	3-31
3.5.1 Monitoring of Gas Phase Ozone .....	3-31
3.5.2 Monitoring of Liquid Phase Residual Ozone .....	3-35
3.5.3 Bromate Monitoring for Systems Using Ozone .....	3-37
3.6 OPERATIONAL CONSIDERATIONS .....	3-38
3.6.1 Process Considerations .....	3-38
3.6.2 Space Requirements .....	3-38
3.6.3 Material Selection .....	3-39
3.6.4 Ozone System Maintenance .....	3-39
3.6.5 Ozone Safety .....	3-39
3.7 SUMMARY .....	3-41
3.7.1 Advantages and Disadvantages of Ozone Use .....	3-41
3.7.2 Summary Table .....	3-42
3.8 REFERENCES .....	3-43
Table 3-1. Types of Compressors Used in Air Preparation Systems .....	3-7
Table 3-2. Comparison of Air and High Purity Oxygen Feed Systems .....	3-8
Table 3-3. Comparison of Primary Characteristics of Low, Medium, and High Frequency Ozone Generators ....	3-10
Table 3-4. Bubble Diffuser Contactor Advantages and Disadvantages .....	3-12
Table 3-5. Injection Contacting Advantages and Disadvantages .....	3-13
Table 3-6. Turbine Mixer Contactor Advantages and Disadvantages .....	3-14
Table 3-7. Criteria for Selecting Ozone Feed Points for Small Systems .....	3-18
Table 3-8. Summary of Reported Ozonation Requirements for 99 Percent Inactivation of <i>Cryptosporidium</i> Oocysts .....	3-27
Table 3-9. Principal Known Byproducts of Ozonation .....	3-28
Table 3-10. Characteristics and Comparisons of Gas-Phase Ozone Analytical Methods .....	3-33
Table 3-11. Characteristics and Comparisons of Residual Ozone Analytical Methods .....	3-36
Table 3-12. Summary of Ozone Disinfection Considerations .....	3-42
Figure 3-1. Oxidation Reactions of Compounds (Substrate) During Ozonation of Water .....	3-2
Figure 3-2. Reaction of Ozone and Bromide Ion Can Produce Bromate Ion and Brominated Organics .....	3-3
Figure 3-3. Basic Ozone Generator .....	3-4
Figure 3-5. Schematic of an Air Preparation System .....	3-7

Figure 3-6. Cylindrical Electrode Schematic ..... 3-9  
Figure 3-7. Ozone Bubble Contactor..... 3-11  
Figure 3-8. Sidestream Ozone Injection System ..... 3-12  
Figure 3-9. Turbine Mixer Ozone Contactor ..... 3-14  
Figure 3-10. CT Values for Inactivation of Viruses by Ozone (pH 6 to 9)..... 3-26  
Figure 3-11. Principal Reactions Producing Ozone Byproducts ..... 3-28  
Figure 3-12. Main Pathways of Bromate Ion Formation when Ozone Reacts with Bromide Ion ..... 3-30

# 4. CHLORINE DIOXIDE

---

Since the beginning of the twentieth century, when it was first used at a spa in Ostend, Belgium, chlorine dioxide has been known as a powerful disinfectant of water. During the 1950s, it was introduced more generally as a drinking water disinfectant since it provided less organoleptic hindering than chlorine. Approximately 700 to 900 public water systems use chlorine dioxide to treat potable water (Hoehn, 1992). Today, the major uses of chlorine dioxide are:

- CT disinfection credit;
- Preoxidant to control tastes and odor;
- Control of iron and manganese; and
- Control of hydrogen sulfide and phenolic compounds.

## 4.1 Chlorine Dioxide Chemistry

### 4.1.1 Oxidation Potential

The metabolism of microorganisms and consequently their ability to survive and propagate are influenced by the oxidation reduction potential (ORP) of the medium in which it lives (USEPA, 1996).

Chlorine dioxide ( $\text{ClO}_2$ ) is a neutral compound of chlorine in the +IV oxidation state. It disinfects by oxidation; however, it does not chlorinate. It is a relatively small, volatile, and highly energetic molecule, and a free radical even while in dilute aqueous solutions. At high concentrations, it reacts violently with reducing agents. However, it is stable in dilute solution in a closed container in the absence of light (AWWA, 1990). Chlorine dioxide functions as a highly selective oxidant due to its unique, one-electron transfer mechanism where it is reduced to chlorite ( $\text{ClO}_2^-$ ) (Hoehn et al., 1996). The pKa for the chlorite ion, chlorous acid equilibrium, is extremely low at pH 1.8. This is remarkably different from the hypochlorous acid/hypochlorite base ion pair equilibrium found near neutrality, and indicates the chlorite ion will exist as the dominant species in drinking water. The oxidation reduction of some key reactions are (CRC, 1990):



Other important half reactions are:



In drinking water, chlorite ( $\text{ClO}_2^-$ ) is the predominant reaction endproduct, with approximately 50 to 70 percent of the chlorine dioxide converted to chlorite and 30 percent to chlorate ( $\text{ClO}_3^-$ ) and chloride ( $\text{Cl}^-$ ) (Werdehoff and Singer, 1987).

## 4.2 Generation

### 4.2.1 Introduction

One of the most important physical properties of chlorine dioxide is its high solubility in water, particularly in chilled water. In contrast to the hydrolysis of chlorine gas in water, chlorine dioxide in water does not hydrolyze to any appreciable extent but remains in solution as a dissolved gas (Aieta and Berg, 1986). It is approximately 10 times more soluble than chlorine (above  $11^\circ\text{C}$ ), while it is extremely volatile and can be easily removed from dilute aqueous solutions with minimal aeration or recarbonation with carbon dioxide (e.g. softening plants). Above 11 to  $12^\circ\text{C}$ , the free radical is found in gaseous form. This characteristic may affect chlorine dioxide's effectiveness when batching solutions and plumbing appropriate injection points. Other concerns are the increased difficulty in analyzing for specific compounds in the presence of many interfering compounds/residual longevity and volatility of gaseous compounds. In the gaseous form, the free radicals also react slowly with water. The reaction rate is 7 to 10 million times slower than that of the hydrolysis rate for chlorine gas (Gates, 1989).

Chlorine dioxide cannot be compressed or stored commercially as a gas because it is explosive under pressure. Therefore, it is never shipped. Chlorine dioxide is considered explosive at higher concentrations which exceed 10 percent by volume in air, and its ignition temperature is about  $130^\circ\text{C}$  ( $266^\circ\text{F}$ ) at partial pressures (National Safety Council Data Sheet 525 –  $\text{ClO}_2$ , 1967). Strong aqueous solutions of chlorine dioxide will release gaseous chlorine dioxide into a closed atmosphere above the solution at levels that may exceed critical concentrations. Some newer generators produce a continuous supply of dilute gaseous chlorine dioxide in the range of 100 to 300 mm-Hg (abs) rather than in an aqueous solution (National Safety Council, 1997). For potable water treatment processes, aqueous solutions between 0.1 and 0.5 percent are common from a number of current generation technologies.

Most commercial generators use sodium chlorite ( $\text{NaClO}_2$ ) as the common precursor feedstock chemical to generate chlorine dioxide for drinking water application. Recently, production of chlorine dioxide from sodium chlorate ( $\text{NaClO}_3$ ) has been introduced as a generation method where in  $\text{NaClO}_3$  is reduced by a mixture of concentrated hydrogen peroxide ( $\text{H}_2\text{O}_2$ ) and concentrated sulfuric acid ( $\text{H}_2\text{SO}_4$ ). Chlorate-based systems have traditionally been used in pulp and paper applications, but have recently been tested full-scale at two U.S. municipal water treatment plants. This is an emerging technology in the drinking water field and is not discussed in this guidance manual.

## 4.2.2 Chlorine Dioxide Purity

Chlorine dioxide generators are operated to obtain the maximum production (yield) of chlorine dioxide, while minimizing free chlorine or other residual oxidant formation. The specified yield for chlorine dioxide generators is typically greater than 95 percent. In addition, the measurable excess chlorine should be less than 2 percent by weight in the generator effluent. Generator yield is defined as (Gordon et al., 1990):

$$\text{Yield} = \frac{[\text{ClO}_2]}{[\text{ClO}_2] + [\text{ClO}_2^-] + \left(\frac{67.45}{83.45}\right)[\text{ClO}_3^-]} \times 100$$

Where:  $[\text{ClO}_2]$  = Chlorine dioxide concentration, mg/L.

$[\text{ClO}_2^-]$  = Chlorite concentration, mg/L.

$[\text{ClO}_3^-]$  = Chlorate concentration, mg/L.

$\left(\frac{67.45}{83.45}\right)$  = Molecular weight ratio of  $\text{ClO}_2^-$  to  $\text{ClO}_3^-$ .

Since any chlorite ion fed to the generator may result in the formation of  $\text{ClO}_2$ ,  $\text{ClO}_2^-$ , or  $\text{ClO}_3^-$ , the purity of the resultant mixture can be calculated using the concentrations of each of the species from appropriate analytical measurements. The determination of purity requires neither flow measurement, mass recoveries, nor manufacturer-based methods to determine production “yield,” “theoretical yield,” “efficiency,” or conversion for any precursor feedstock. This approach does not require flow measurements that can introduce up to 5 percent error in the calculations.

Utilities that use chlorine dioxide should measure excess chlorine (as FAC) in the generator effluent in addition to the  $\text{ClO}_2^-$  related species. FAC may appear as false  $\text{ClO}_2$  residuals for CT purposes, or result in the formation of chlorinated DBPs if high, relative to the  $\text{ClO}_2$  level in the generated mixture. Excess chlorine is defined as:

$$\text{Excess Cl}_2 = \frac{[\text{Cl}_2]}{[\text{ClO}_2] + [\text{ClO}_2^-] + \left(\frac{67.45}{83.45}\right)[\text{ClO}_3^-] \times \frac{70.91}{2 \times 67.45}} \times 100$$

Where:  $\frac{70.91}{(2 \times 67.45)}$  = stoichiometric and molecular weight ratio of  $\text{Cl}_2$  to  $\text{ClO}_2^-$ .

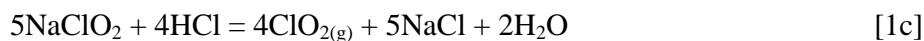
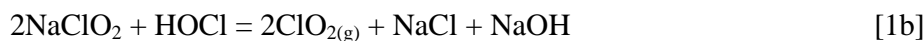
The following represents a summarily simpler equation that substantially resolves the problems of different equipment-specific calibration methods, chlorine-contaminated  $\text{ClO}_2$ , or low efficiency conversion of either chlorite- or chlorate-based precursor material.

$$\text{Purity} = \frac{[\text{ClO}_2]}{[\text{ClO}_2] + [\text{FAC}] + [\text{ClO}_2^-] + [\text{ClO}_3^-]} \times 100$$

This practical (weight-based) calculation permits a variety of approved analytical methods (discussed in section 4.6) to be used to assess generator performance on unbiased scientific principles, rather than non-standardized manufacturer specifications.

### 4.2.3 Methods of Generating Chlorine Dioxide

For potable water application, chlorine dioxide is generated from sodium chlorite solutions. The principal generation reactions that occur in the majority of generators have been known for a long time. Chlorine dioxide can be formed by sodium chlorite reacting with gaseous chlorine ( $\text{Cl}_{2(\text{g})}$ ), hypochlorous acid ( $\text{HOCl}$ ), or hydrochloric acid ( $\text{HCl}$ ). The reactions are:



Reactions [1a], [1b], and [1c] explain how generators can differ even though the same feedstock chemicals are used, and why some should be pH controlled and others are not so dependent on low pH. In most commercial generators, there may be more than one reaction taking place. For example, the formation and action of hypochlorous acid as an intermediate (formed in aqueous solutions of chlorine) often obscures the “overall” reaction for chlorine dioxide production.

Table 4-1 provides information on some types of available commercial generators. Conventional systems react sodium chlorite with either acid, aqueous chlorine, or gaseous chlorine. Emergent technologies identified in Table 4-1 include electrochemical systems, a solid chlorite inert matrix (flow-through gaseous chlorine) and a chlorate-based emerging technology that uses concentrated hydrogen peroxide and sulfuric acid.

**Table 4-1. Commercial Chlorine Dioxide Generators**

GENERATOR TYPE	MAIN REACTIONS Reactants, byproducts, key reactions, and chemistry notes	SPECIAL ATTRIBUTES
ACID-CHLORITE: (Direct Acid System)	$4\text{HCl} + 5\text{NaClO}_2 \rightarrow 4\text{ClO}_{2(\text{aq})} + \text{ClO}_3^-$ <ul style="list-style-type: none"> <li>• Low pH</li> <li>• <math>\text{ClO}_3^-</math> possible</li> <li>• Slow reaction rates</li> </ul>	Chemical feed pump interlocks required. Production limit ~ 25-30 lb/day. Maximum yield at ~80% efficiency.
AQUEOUS CHLORINE- CHLORITE: ( $\text{Cl}_2$ gas ejectors with chemical pumps for liquids or booster pump for ejector water).	$\text{Cl}_2 + \text{H}_2\text{O} \rightarrow [\text{HOCl} / \text{HCl}]$  $[\text{HOCl}/\text{HCl}] + \text{NaClO}_2 \rightarrow \text{ClO}_{2(\text{g})} + \text{H}/\text{OCl} + \text{NaOH} + \text{ClO}_3^-$ <ul style="list-style-type: none"> <li>• Low pH</li> <li>• <math>\text{ClO}_3^-</math> possible</li> <li>• Relatively slow reaction rates</li> </ul>	Excess $\text{Cl}_2$ or acid to neutralize NaOH. Production rates limited to ~ 1000 lb/day. High conversion but yield only 80-92% More corrosive effluent due to low pH (~2.8-3.5). Three chemical systems pump HCl, hypochlorite, chlorite, and dilution water to reaction chamber.
RECYCLED AQUEOUS CHLORINE OR "FRENCH LOOP" <sup>TM</sup> (Saturated $\text{Cl}_2$ solution via a recycling loop prior to mixing with chlorite solution.)	$2\text{HOCl} + 2\text{NaClO}_2 \rightarrow 2\text{ClO}_2 + \text{Cl}_2 + 2\text{NaOH}$  <ul style="list-style-type: none"> <li>• Excess <math>\text{Cl}_2</math> or HCl needed due to NaOH formed.</li> </ul>	Concentration of ~3 g/L required for maximum efficiency. Production rate limited to ~ 1000 lb/day. Yield of 92-98% with ~10% excess $\text{Cl}_2$ reported. Highly corrosive to pumps; draw-down calibration needed. Maturation tank required after mixing.
GASEOUS CHLORINE- CHLORITE (Gaseous $\text{Cl}_2$ and 25% solution of sodium chlorite; pulled by ejector into the reaction column.)	$\text{Cl}_{2(\text{g})} + \text{NaClO}_{2(\text{aq})} \rightarrow \text{ClO}_{2(\text{aq})}$ <ul style="list-style-type: none"> <li>• Neutral pH</li> <li>• Rapid reaction</li> <li>• Potential scaling in reactor under vacuum due to hardness of feedstock.</li> </ul>	Production rates 5-120,000 lb/day. Ejector-based, with no pumps. Motive water is dilution water. Near neutral pH effluent. No excess $\text{Cl}_2$ . Turndown rated at 5-10X with yield of 95-99%. Less than 2% excess $\text{Cl}_2$ . Highly calibrated flow meters with min. line pressure ~ 40 psig needed.
GASEOUS CHLORINE- SOLIDS CHLORITE MATRIX (Humidified $\text{Cl}_2$ gas is pulled or pumped through a stable matrix containing solid sodium chlorite.)	$\text{Cl}_{2(\text{g})} + \text{NaClO}_{2(\text{s})} \rightarrow \text{ClO}_{2(\text{g})} + \text{NaCl}$ <ul style="list-style-type: none"> <li>• Rapid reaction rate</li> <li>• New technology</li> </ul>	$\text{Cl}_2$ gas diluted with $\text{N}_2$ or filtered air to produce ~8% gaseous $\text{ClO}_2$ stream. Infinite turndown is possible with >99% yield. Maximum rate to ~1200 lb/day per column; ganged to >10,000 lb/day.
ELECTROCHEMICAL (Continuous generation of $\text{ClO}_2$ from 25% chlorite solution recycled through electrolyte cell)	$\text{NaClO}_{2(\text{aq})} \rightarrow \text{ClO}_{2(\text{aq})} + \text{e}^-$ <ul style="list-style-type: none"> <li>• New technology</li> </ul>	Counter-current chilled water stream accepts gaseous $\text{ClO}_2$ from production cell after it diffuses across the gas permeable membrane. Small one-pass system requires precise flow for power requirements (Coulombs law).
ACID/PEROXIDE/CHLORIDE	$2\text{NaClO}_3 + \text{H}_2\text{O}_2 + \text{H}_2\text{SO}_4 \rightarrow 2\text{ClO}_2 + \text{O}_2 + \text{NaSO}_4 + \text{H}_2\text{O}$	Uses concentrated $\text{H}_2\text{O}_2$ and $\text{H}_2\text{SO}_4$ . Downscaled version; Foam binding; Low pH.

Source: Adapted from Gates, 1998.

#### 4.1.1.1 Commercial Generators

The conventional chlorine-chlorite solution method generates chlorine dioxide in a two-step process. First, chlorine gas is reacted with water to form hypochlorous acid and hydrochloric acid. These

acids then react with sodium chlorite to form chlorine dioxide. The ratio of sodium chlorite to hypochlorous acid should be carefully controlled. Insufficient chlorine feed will result in a large amount of unreacted chlorite. Excess chlorine feed may result in the formation of chlorate ion, which is an oxidation product of chlorine dioxide and not currently regulated.

**Acid-Chlorite Solution** - Chlorine dioxide can be generated in direct-acidification generators by acidification of sodium chlorite solution. Several stoichiometric reactions have been reported for such processes (Gordon et al., 1972). When chlorine dioxide is generated in this way, hydrochloric acid is generally preferred (Reaction [1c]).

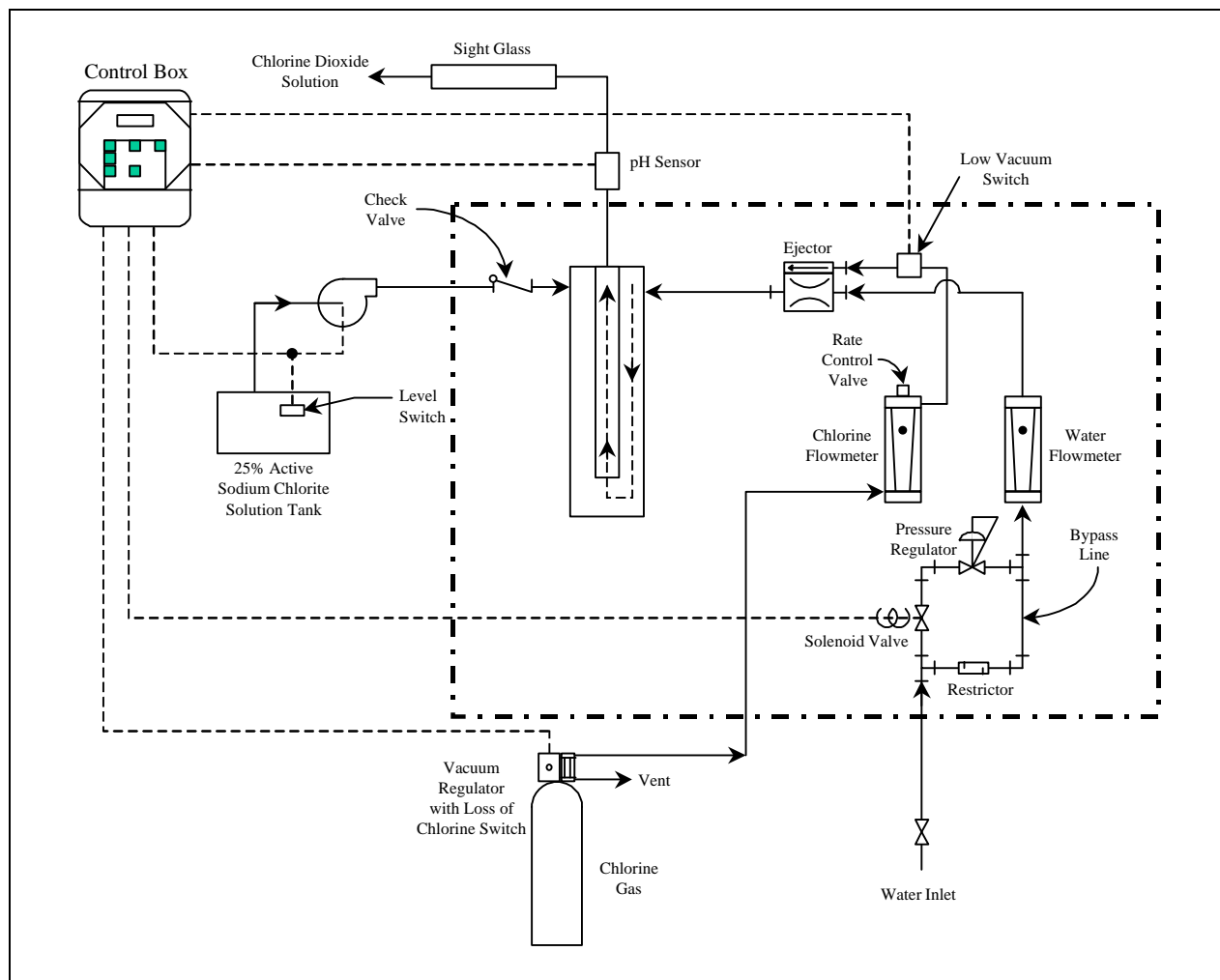
**Aqueous Chlorine-Chlorite Solution** - Chlorite ion (from dissolved sodium chlorite) will react with hydrochloric acid and hypochlorous acid to form chlorine dioxide in these systems, commonly referred to as conventional systems (Reaction [1b]):

Figure 4-1 shows a typical chlorine dioxide generator using aqueous chlorine-chlorite solution (Demers and Renner, 1992).

If chlorine gas and chlorite ion are allowed to react under ideal conditions (not usually formed in aqueous chlorine type systems), the resulting pH of the effluent may be close to 7. To fully utilize sodium chlorite solution, the more expensive of the two ingredients, excess chlorine is often used. This approach lowers the pH and drives the reaction further toward completion. The reaction is faster than the acid-chlorite solution method, but much slower than the other commercial methods described in the following discussion.

**Recycled Aqueous Chlorine or “French Loop”™** - In this aqueous chlorine design, shown in Figure 4-2, chlorine gas is injected into a continuously circulating water loop. This eliminates the need for a great excess of Cl<sub>2</sub> gas to be fed to the generator since the molecular chlorine will dissolve in the feed water, and thus maintain a low pH level of the feed water. Loop-based generators keep chlorine at or above saturation levels. The low pH condition results in high yields of chlorine dioxide (greater than 95 percent at design production rate) (Thompson, 1989). Chlorine in the generator effluent may react with chlorine dioxide to form chlorate if allowed to stand in batch storage too long. The “French Loop” type of generator is more difficult to operate due to system start-up and control of sodium chlorite feed rate (meter pump), chlorine feed rate (rotameter), and the recirculating loop (pump). Newer designs incorporate a second batching tank for continuous aqueous chlorine storage, thus removing many of these startup or recycling difficulties.

**Gaseous Chlorine-Chlorite Solution** - Sodium chlorite solution can be “vaporized” and reacted under vacuum with molecular gaseous chlorine. This process uses undiluted reactants and is much more rapid than chlorine solution:chlorite solution methods (Pitochelli, 1995). Production rates are more easily scaled up, and some installed systems have reported producing more than 60,000 pounds per day.



Source: Demers and Renner, 1992.

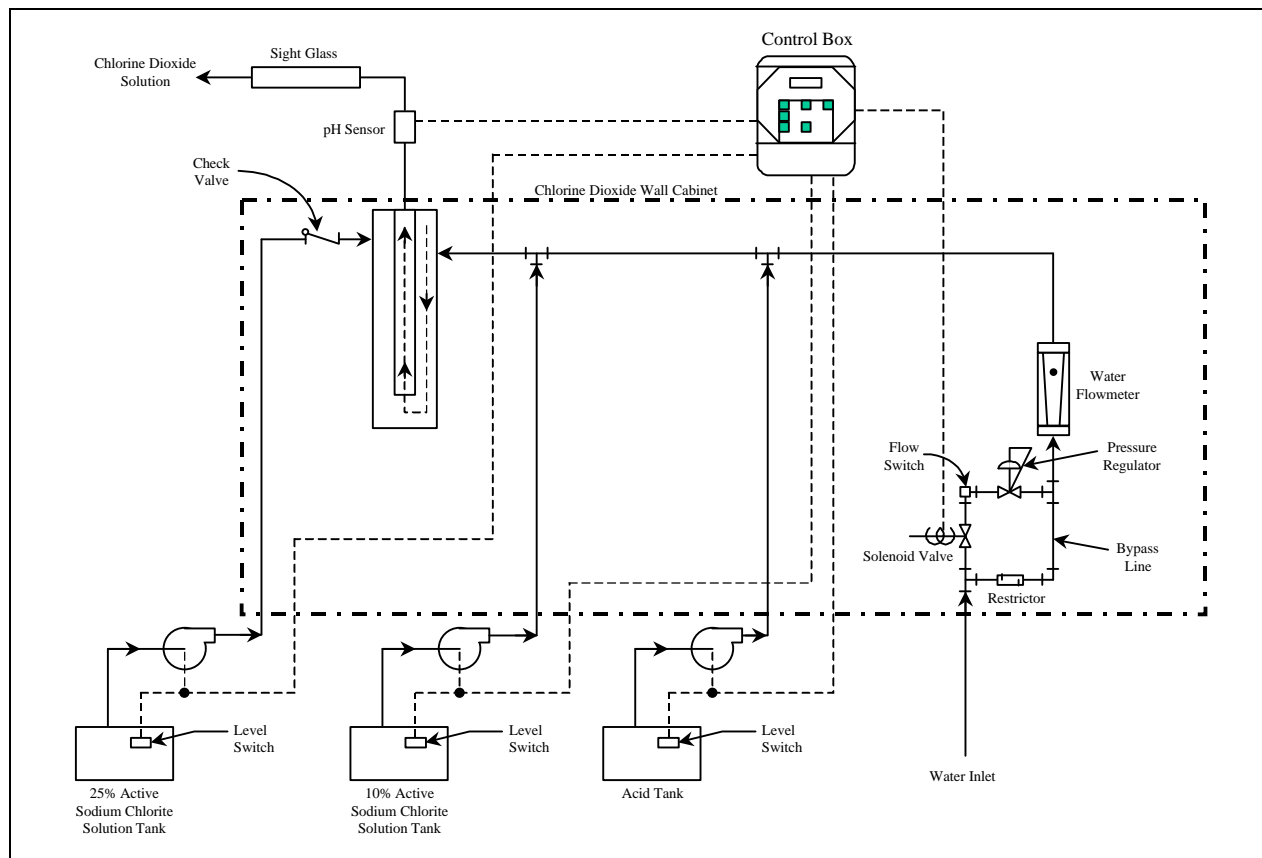
**Figure 4-1. Conventional Chlorine Dioxide Generator When Using Chlorine-Chlorite Method**

The acid-sodium hypochlorite-sodium chlorite method of generating chlorine dioxide is used when chlorine gas is not available. First, sodium hypochlorite is combined with hydrochloric or another acid to form hypochlorous acid. Sodium chlorite is then added to this reaction mixture to produce chlorine dioxide.

#### 4.1.1.2 pH Effects on Chlorine Dioxide Generation

If hypochlorous acid is formed, one of the byproducts of its reaction with sodium chlorite in solution is sodium hydroxide. Since sodium hydroxide is also a common stabilizer of sodium chlorite feedstock, the resulting pH of the mixture can be too high. A high pH slows the formation of chlorine dioxide and impels less efficient chlorate-forming reactions. This is the same process in which chlorite and hypochlorite ions react in drinking water to form chlorate ion. This neutralizing effect of caustic may be influenced by different stabilizers used in each of the types and sources of

sodium chlorite which are approved for use in drinking water under AWWA Standard B303-95 (AWWA, 1995).



Source: Demers and Renner, 1992.

**Figure 4-2. Chlorine Dioxide Generation Using Recycled Aqueous Chlorine Method**

In very low pH aqueous chlorine solutions, chlorous acid (and not the chlorite ion) may be directly oxidized to chlorine dioxide as shown in reaction [1d]. At this low pH, gaseous chlorine remains "dissolved" in the water at concentrations higher than the normal occurrence, and allows reaction [1a] to proceed.

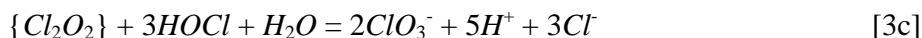


#### 4.1.1.3 Chlorate Byproduct Formation

One of the most undesirable byproducts in generators is the chlorate ion ( $\text{ClO}_3^-$ ). Chlorate production is possible through reactions with the intermediate dimer,  $\{\text{Cl}_2\text{O}_2\}$ . Rather than the chlorite ion being simply "converted" to chlorine dioxide, reactions [1a] through [1d] can result in the supposed formation of the unstable, unsymmetrical intermediate dimer,  $\{\text{Cl}_2\text{O}_2\}$  or  $\{\text{Cl}^-\text{ClO}_2\}$  as shown in reaction [2] (Emmenegger and Gordon, 1967).



In some generators that operate with relatively low initial reactant concentrations, a significant amount of chlorate is formed by reactions with  $\{Cl_2O_2\}$ , as shown in reactions [3a], [3b], and [3c].

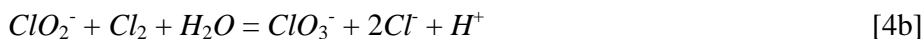


Highly acidic (pH <3) reaction mixtures force the degradation of  $\{Cl_2O_2\}$  to chlorate rather than chlorine dioxide, as well as the direct oxidation of chlorite to chlorate.

The overall reactions that describe chlorate ion formation are:



and



The following conditions may also produce the chlorate ion:

- Excessively high ratios of  $Cl_2$  gas: $ClO_2^-$ .
- Presence of high concentrations of free chlorine at low pH in aqueous solutions.
- Dilute chlorite solutions held at low pH.
- Base-catalyzed disproportionation of chlorine dioxide at high pH values (pH >11).
- Reaction mixtures that are highly acidic (pH <3).
- An excess of hypochlorous acid will directly oxidize chlorite ions to chlorate ions rather than to chlorine dioxide (independent of the rapid formation of the  $\{Cl_2O_2\}$  intermediate).

#### 4.1.4 Generator Design

As hypochlorous acid is formed under acidic conditions, the lowering of optimal concentrations of precursor reactants will also increase chlorate levels in the generator by promoting reaction [3b]. Therefore, if weak precursor feed stocks or high amounts of dilution water are added to the generator, chlorate will be more prevalent (according to reaction [3a]). These limitations explain why generators most often use ~25 percent chlorite solutions and gaseous (or near-saturated aqueous) chlorine. Higher strength solutions of sodium chlorite (e.g., 37 percent) also are more susceptible to crystallization or stratification at ambient temperatures as high as 25°C(78°F).

Due to these dilution effects, some systems function best as "intermittent batch" generators, (that produce high concentrations of chlorine dioxide) rather than as "continuous" generators (that produce lower concentrations (< 1g/L) of chlorine dioxide). The stored solutions are pumped or injected from

the storage tank. Cycling frequently avoids long-term (over 24 hour periods) storage of the generated solution.

Chlorine loop-type systems can obtain high conversion rates if excess chlorine is always present. Excess chlorine permits the molecular chlorine reaction mechanism (described above) to proceed. The low pH of the mixture also minimizes the contribution of OH<sup>-</sup> formed via equation [1b] by neutralizing it. These solutions may still be contaminated with excess chlorine needed to drive the conversion of chlorite ion, but not to the same degree as found in simple aqueous chlorine systems when operated under dilute conditions. Chlorine-loop generators run best at high capacity since the chlorite ion is most available in this production mode.

Conventional or acid-enhanced generators produce chlorine dioxide through the intermediate {Cl<sub>2</sub>O<sub>2</sub>} as long as relatively high concentrations of reactants (~above 20–30 g/L) are maintained in the reaction chamber prior to dilution. Vapor-phase, recycled loop, and solid chlorite-type generators that minimize dilute aqueous reaction conditions can obtain high efficiencies by preventing any chlorite ion from reacting in the "slower" steps described above. This is accomplished by establishing conditions that force the immediate reaction between chlorite ions and gas-phase or molecular chlorine at a rate hundreds of times faster than the Cl<sub>2</sub> hydrolysis in water. This essentially minimizes the impact of competitive chlorine hydrolysis or acidification on the dominant [ClO<sub>2</sub><sup>-</sup>:Cl<sub>2</sub> gas] mechanism, and prevents the chlorite ion reacting with hypochlorous acid directly.

In all generators, large excess amounts of Cl<sub>2</sub> may result in the over-oxidization of chlorite and directly form chlorate in aqueous solution (reaction [4b]). Precursor chemical feed rates for the generators should always be adjusted to chart settings supplied with generators, notably with the continuous flow, direct gas injection systems. Re-calibration of these systems is sometimes needed on-site if feed stock sodium chlorite is not of the correct strength, or if pre-calibrated flow devices have been replaced.

If aqueous chlorine solutions are mixed with sodium chlorite feed stock solutions, the following mechanisms are dominant, which may affect the formation rates of chlorine dioxide:

- Chlorine gas reacts with water to form hypochlorous and hydrochloric acids, rather than directly with chlorite to form chlorine dioxide. (Water and chlorite both compete for the Cl<sub>2</sub> molecule simultaneously) (see equations [4.1a-c] and Section 6.1.1).
- Chlorate ion is formed (reactions [3a], [3b], and [3c]).
- Only 4 moles of chlorine dioxide are obtained from 5 moles of sodium chlorite via direct acidification (reaction [1c]). This may become important at low pH and high chloride ion levels.

The practical side of all of this is that different generators operate under different optimal conditions. For example, reactor columns should not be continuously flooded with excess water in vapor-phase systems. It is the main reason why dry chlorite-based generator reactor columns should not get wet. Over-dilution of the precursor reactants themselves will lower conversion efficiencies due to the

avored formation of chlorate over chlorine dioxide. Batch-type generation should always be carried out at maximal  $\text{ClO}_2$  concentration with appropriate adjustments at the pump (located downstream of the reactor at the batch tank) for dosage or flow. Changes in chlorine dioxide concentrations in the batch tanks would then be minimized, and pump calibration does not need to include a broad range of chlorine dioxide levels. For the newer gas chlorine generators using dry sodium chlorite in an inert matrix, small amounts of humidifying water in the mixture do not interfere significantly with the simple gaseous  $\text{Cl}_2:\text{ClO}_2^-$  reaction. These small traces of water allow for continuous exposure of  $\text{ClO}_2^-$  on the inert surfaces within the reactor column.

Chlorine dioxide generators are relatively simple mixing chambers. The reactors are frequently filled with media (Teflon™ chips, ceramic or raschig rings) to generate hydraulic turbulence for mixing. A sample petcock valve on the discharge side of the generator is desirable to allow for monitoring of the generation process.

The *Recommended Standards for Water Works* (GLUMRB, 1992) and drinking water design textbooks such as *Unit Processes in Drinking Water Treatment* by Masschelein (1992) are excellent sources for chlorine dioxide generation design criteria and application.

### 4.1.5 Chemical Feed Systems

Fiberglass Reinforced vinyl ester Plastic (FRP) or High Density Linear Polyethylene (HDLPE) tanks with no internal insulation or heat probes are recommended for bulk storage of 25 to 38 percent solution sodium chlorite. Nozzles should include truck unloading vents and local level and temperature indication. Transfer pumps should be centrifugal with 316 stainless steel, fiberglass, Hypalon™, wetted Teflon™ parts, or epoxy resins. The pump should be sealless or equipped with double mechanical seals. The recommended piping material is CPVC, although vinyl ester or Teflon™ piping systems are acceptable. Carbon steel and stainless steel piping systems are not recommended.

Depending upon system size, sodium chlorite can be purchased in 55-gallon drums, 275-gallon non-returnable totes, or in bulk quantities. A 30-day storage supply of sodium chlorite can easily be met for most small systems by using 55-gallon drums. A 55-gallon drum weighs approximately 600 lbs. Equipment should be provided such that one person can easily handle a drum. All gaseous chlorine or hypochlorite solution-related plumbing should follow Chlorine Institute directives.

Storage and chlorine dioxide systems typically include the following:

- Storage and feeding in a designated space.
- Use of non-combustible materials such as concrete for construction.
- Storage in clean, closed, non-translucent containers. Exposure to sunlight, UV light, or excessive heat will reduce product strength.

- Avoid storage and handling of combustible or reactive materials, such as acids or organic materials, in the sodium chlorite area.
- Secondary containment for storage and handling areas to handle the worse case spill with sumps provided to facilitate recovery.
- A water supply near storage and handling areas for cleanup.
- Inert material should be used in contact with the strong oxidizing and/or acid solutions involved in chlorine dioxide systems.
- Storage tanks with vents to outside.
- Adequate ventilation and air monitoring.
- Gas masks and first aid kits outside of the chemical areas.
- Reactor with glass view ports if it is not made of transparent material.
- Flow monitoring on all chemical feed lines, dilution water lines, and chlorine dioxide solution lines.
- Dilution water should not be excessively hard in order to avoid calcium deposits and should be near neutral pH.
- On-site and frequent testing of chemical solution strengths should be practiced to achieve efficient process control.
- Air contact with chlorine dioxide solutions should be controlled to limit the potential for explosive concentrations possibly building up within the generator. Chlorine dioxide concentrations in air higher than 8 to 10 percent volume should be avoided. Two methods can be applied: operation under vacuum or storage under higher positive pressure (45 to 75 psig) to prevent buildup of gas-phase  $\text{ClO}_2$  in the head space. Bulk storage (batch) tanks containing  $\text{ClO}_2$  should be suitably vented to atmosphere.

Sodium chlorite solution feed pumps are commonly diaphragm-metering pumps for liquid feed rate control. If centrifugal pumps are used, the only acceptable packing material is Teflon. If lubrication is needed, minimum quantities of fire-resistant lubricants should be used. Pump motors should be totally enclosed, fan-cooled (TEFC) with sealed-for-life bearings. Couplings should be of the greaseless type. Water lines for mechanical seals should have a pressure gauge and throttling valve on the outlet side. Visual means should be provided to verify adequate water flow. Each pump should include a calibration chamber.

Pipes carrying sodium chlorite should be provided sufficient support to minimize risk of overstressing joints. Flexible connections to pumps should also be provided to minimize risk of vibration damage. Pipe should be sloped to drainage points and valved hose connections provided at strategic points for efficient flushing and draining. Service water for flushing feed lines should be introduced only through temporarily connected hoses protected by a backflow preventer. Service water lines should include check valves. Hose connections from service water lines should have a vent valve to release pressure before the hose is disconnected after use.

Flows are frequently measured with magnetic flow meters, mass flow meters, or rotameters for precise control. Provisions should always be made for back-flow prevention. Sodium chlorite is extremely reactive, especially in the dry form, and care should be taken to protect against potentially explosive conditions.

Chlorine dioxide solution concentrations below about 10 g/L will not produce sufficiently high vapor pressures to present an explosion hazard under most ambient conditions of temperature and pressure. In water treatment, chlorine dioxide solution concentrations rarely exceed 4 g/L for temperatures less than 40°C, and treatment levels generally range from 0.1 to 5.0 mg/L. If temperatures exceed 50°C, storage tanks should be suitably vented due to the higher levels of ClO<sub>2</sub> possible. As cold service/potable water is typically used as generator dilution water, these conditions are rarely encountered.

#### **4.1.6 Generator Power Requirements**

Generator power requirements are similar to those for chlorination systems. For all generators (20 to 12,000 lb/day) power can be supplied from 120 VAC single phase, to 480 VAC three phase. Power demand will vary based upon make-up water pressure available to operate the venturi. Fractional horsepower metering pumps are required, based upon system configuration.

### **4.3 Primary Uses and Points of Application for Chlorine Dioxide**

The calculation of CT for chlorine dioxide is similar to other disinfectants, with accurate determinations of residual concentrations being a prerequisite for effective disinfection. Primary disinfectant credit is achieved by the residual concentration and the effective contact time. It has been found in practice that because of the volatile nature of the gas, chlorine dioxide works extremely well in plug flow reactors such as pipe lines. It can be easily removed from dilute aqueous solution by turbulent aeration in rapid mix tanks or purging in recarbonation basins. CT credits should not be expected through a filter because the likelihood that no residual remains in the filtered water (DeMers and Renner, 1992). For post CT disinfection credit, chlorine dioxide can be added before clearwells or transfer pipelines. Ample sampling points should be included to allow close monitoring of residual concentrations. It is well known that chlorine dioxide is commonly destroyed by UV in basins exposed to sunlight or bright fluorescent lights. Therefore, protective design elements should be incorporated if such exposure is anticipated.

#### **4.3.1 Disinfection**

Before chlorine dioxide is selected for use as a primary disinfectant an oxidant demand study should be completed. Ideally, this study should consider the seasonal variations in water quality, temperature, and application points. Table 4-2 shows typical results for a single sample of a demand study completed on a surface water source.

The MRDL for chlorine dioxide is 0.8 mg/L and the MCL for chlorite is 1.0 mg/L per the D/DBP rule. This means that if the oxidant demand is greater than about 1.4 mg/L, chlorine dioxide may not be used as a disinfectant because the chlorite/chlorate ions byproduct, might exceed the maximum level allowed, unless inorganic byproducts (e.g., chlorite) are subsequently removed. There are numerous means to reduce excessive chlorite levels prior to chlorination in conventional water plants.

**Table 4-2. Surface Water Chlorine Dioxide Demand Study Results**

Dose (mg/L)	Time (min)	ClO <sub>2</sub> (mg/L)	ClO <sub>2</sub> <sup>-</sup> (mg/L)	ClO <sub>3</sub> <sup>-</sup> (mg/L)
1.4	3	0.47	0.76	0.05
	10	0.30	0.98	0.06
	20	0.23	1.08	0.07
	40	0.16	1.11	0.07
	60	0.11	1.11	0.07

Source: DeMers and Renner, 1992.

Note: \*Raw water sample, 23°C, 8.5 pH.

Typical dosages of chlorine dioxide used as a disinfectant in drinking water treatment range from 0.07 to 2.0 mg/L. For plants using chlorine dioxide, median concentrations of chlorite and chlorate were found to be 0.24 and 0.20 mg/L, respectively in an EPA survey (USEPA, 1998), the standard is 1.0 mg/L.

### 4.3.2 Taste and Odor Control

A common application of chlorine dioxide in drinking water in the United States has been for control of tastes and odors associated with algae and decaying vegetation. Chlorine dioxide is also effective in destroying taste and odor producing phenolic compounds. The recommended location for application of chlorine dioxide for this purpose will depend on raw water quality, the type of treatment plant and any other purposes for chlorine dioxide addition. In conventional treatment plants, it is recommended that chlorine dioxide be added near the end of or following, the sedimentation basin. If the raw water turbidity is low (for example, less than 10 NTU), chlorine dioxide can be added at the beginning of the plant. Some utilities follow this practice because chlorine dioxide is effective in controlling algae growth in flocculation and sedimentation basins that are exposed to sunlight (DeMers and Renner, 1992). Such application during periods of darkness may be more successful for nuisance algae control.

### 4.3.3 Oxidation of Iron and Manganese

Chlorine dioxide can be used to oxidize both iron and manganese. Chlorine dioxide reacts with the soluble forms of iron and manganese to form precipitates that can be removed through sedimentation and filtration. Chlorine dioxide reduces to chlorite ion in this reaction (Knocke et al., 1993). About 1.2 mg/L of chlorine dioxide is required to remove 1.0 mg/L of iron, and 2.5 mg/L of chlorine dioxide are required to remove 1.0 mg/L of manganese. For high concentrations of iron and manganese, the use of chlorine dioxide is limited to the 1.0 mg/L chlorite/chlorate ion byproduct, as

described before. Ferrous iron may be added prior to conventional coagulation to chemically reduce chlorite ion (to chloride ion) and improve the overall flocculation process.

## 4.4 Pathogen Inactivation and Disinfection Efficacy

For water treatment, chlorine dioxide has several advantages over chlorine and other disinfectants. In contrast to chlorine, chlorine dioxide remains in its molecular form in the pH range typically found in natural waters (Roberts et al., 1980). Chlorine dioxide is a strong oxidant and disinfectant. Its disinfection mechanisms are not well understood, but appear to vary by type of microorganism

### 4.4.1 Inactivation Mechanisms

Gross physical damage to bacterial cells or viral capsids has not been observed at the low concentrations of chlorine dioxide typically used to disinfect drinking water. Therefore, studies have focused primarily on two more subtle mechanisms that lead to the inactivation of microorganisms: determining specific chemical reactions between chlorine dioxide and biomolecules; and observing the effect chlorine dioxide has on physiological functions.

In the first disinfection mechanism, chlorine dioxide reacts readily with amino acids cysteine, tryptophan, and tyrosine, but not with viral ribonucleic acid (RNA) (Noss et al., 1983; Olivier et al., 1985). From this research, it was concluded that chlorine dioxide inactivated viruses by altering the viral capsid proteins. However, chlorine dioxide reacts with poliovirus RNA and impairs RNA synthesis (Alvarez and O'Brien, 1982). It has also been shown that chlorine dioxide reacts with free fatty acids (Ghandbari et al., 1983). At this time, it is unclear whether the primary mode of inactivation for chlorine dioxide lies in the peripheral structures or nucleic acids. Perhaps reactions in both regions contribute to pathogen inactivation.

The second type of disinfection mechanism focuses on the effect of chlorine dioxide on physiological functions. It has been suggested that the primary mechanism for inactivation was the disruption of protein synthesis (Bernarde et al., 1967a). However, later studies reported the inhibition of protein synthesis may not be the primary inactivation mechanism (Roller et al., 1980). A more recent study reported that chlorine dioxide disrupted the permeability of the outer membrane (Aieta and Berg, 1986). The results of this study were supported by the findings of Olivieri et al. (1985) and Ghandbari et al. (1983), which found that the outer membrane proteins and lipids were sufficiently altered by chlorine dioxide to increase permeability.

### 4.4.2 Environmental Effects

Studies have been performed to determine the effect of pH, temperature, and suspended matter on the disinfection efficiency of chlorine dioxide. Following is a summary of the effects these parameters have on pathogen inactivation.

#### 4.4.2.1 pH

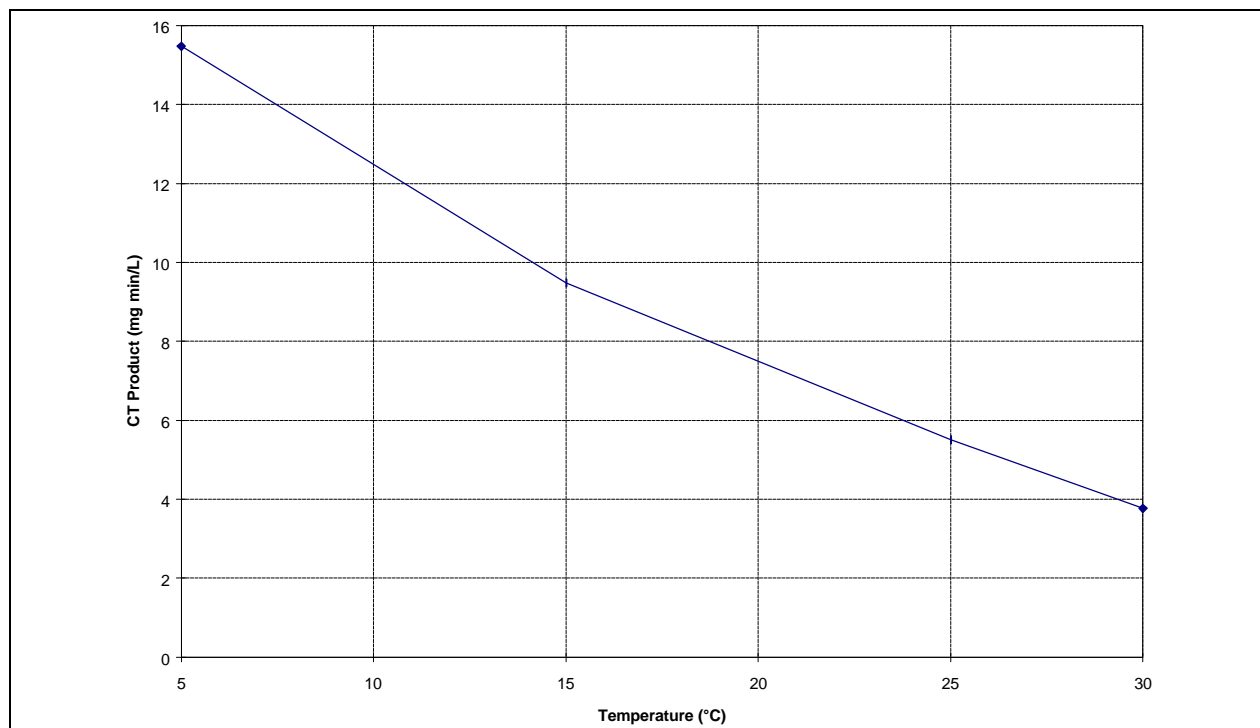
In comparison to chlorine, studies have shown that pH has much less effect on pathogen inactivation for viruses and cysts with chlorine dioxide than with chlorine in the pH range of 6 to 8.5. Unlike chlorine, studies on chlorine dioxide have shown the degree of inactivation of poliovirus 1 (Scarpino et al., 1979) and *Naegleria gruberi* cysts (Chen et al., 1984) increase as the pH increases.

The results of studies on *E. coli* inactivation are inconclusive. It has been found that the degree of inactivation by chlorine dioxide increases as pH increases (Bernarde et al., 1967a). However, an earlier study found that the bactericidal activity of chlorine dioxide was not affected by pH values in the range of 6.0 to 10.0 (Ridenour and Ingols, 1947). A recent study on *Cryptosporidium* found that inactivation of oocysts using chlorine dioxide occurred more rapidly at a pH of 8.0 than 6.0. At a similar CT value, the level of inactivation at pH of 8.0 was approximately twice that at a pH of 6.0 (Le Chevallier et al., 1997). Another study found that chlorine dioxide efficacy increases for *Giardia* inactivation at higher pH levels and that this may be the result of chemical or physical changes in *Giardia* cyst structure rather than pH effects on chlorine dioxide disproportionation (Liyanage et al., 1997). More research is needed to further clarify how pH impacts the effectiveness of chlorine dioxide.

#### 4.4.2.2 Temperature

Similar to chlorine, the disinfection efficiency of chlorine dioxide decreases as temperature decreases (Ridenour and Ingols, 1947). This finding is supported by the data from Chen et al. (1984) shown in Figure 4-3 for the inactivation of *Naegleria gruberi* cysts. The curve shows the CT required to achieve 99 percent inactivation for temperatures between 5 and 30°C.

In a more recent study, LeChevallier et al. (1997) found that reducing the temperature from 20°C to 10°C reduced the disinfection effectiveness of chlorine dioxide on *Cryptosporidium* by 40 percent, which is similar to previous results for *Giardia* and viruses. Gregory et al. (1998) found that even under the most favorable conditions (i.e., at a pH of 8.5), required doses to achieve 2-log *Cryptosporidium* inactivation do not appear to be a feasible alternative, requiring doses of more than 3.0 mg/L with a 60 minute detention time. At neutral pH levels, the required doses may be more than 20 mg/L.



**Figure 4-3. Effect of Temperature on *N. Gruberi* Cyst Inactivation at pH 7**

#### 4.4.2.3 Suspended Matter

Suspended matter and pathogen aggregation affect the disinfection efficiency of chlorine dioxide. Protection from chlorine dioxide inactivation due to bentonite was determined to be approximately 11 percent for turbidities equal to or less than 5 NTUs and 25 percent for turbidities between 5 and 17 NTUs (Chen et al., 1984).

Laboratory studies of poliovirus 1 preparations containing mostly viral aggregates took 2.7 times longer to inactivate with chlorine dioxide than single state viruses (Brigano et al., 1978). Chen et al. (1984) also found that clumps of *Naegleria gruberi* cysts were more resistant to chlorine dioxide than unclumped cysts or clumps of smaller size.

### 4.4.3 Disinfection Efficacy

Several investigations have been made to determine the germicidal efficiency of chlorine dioxide since its introduction in 1944, as a drinking water disinfectant. Most of the investigations were carried out as a comparison to chlorine; some studies have compared chlorine dioxide and ozone. Chloride dioxide is a more effective disinfectant than chlorine but is less effective than ozone.

#### 4.4.3.1 Bacteria Inactivation

Quantitative data were published as early as the 1940s demonstrating the efficacy of chlorine dioxide as a bactericide. In general, chlorine dioxide has been determined to be equal to or superior to chlorine on a mass-dose basis. It was demonstrated that even in the presence of suspended matter,

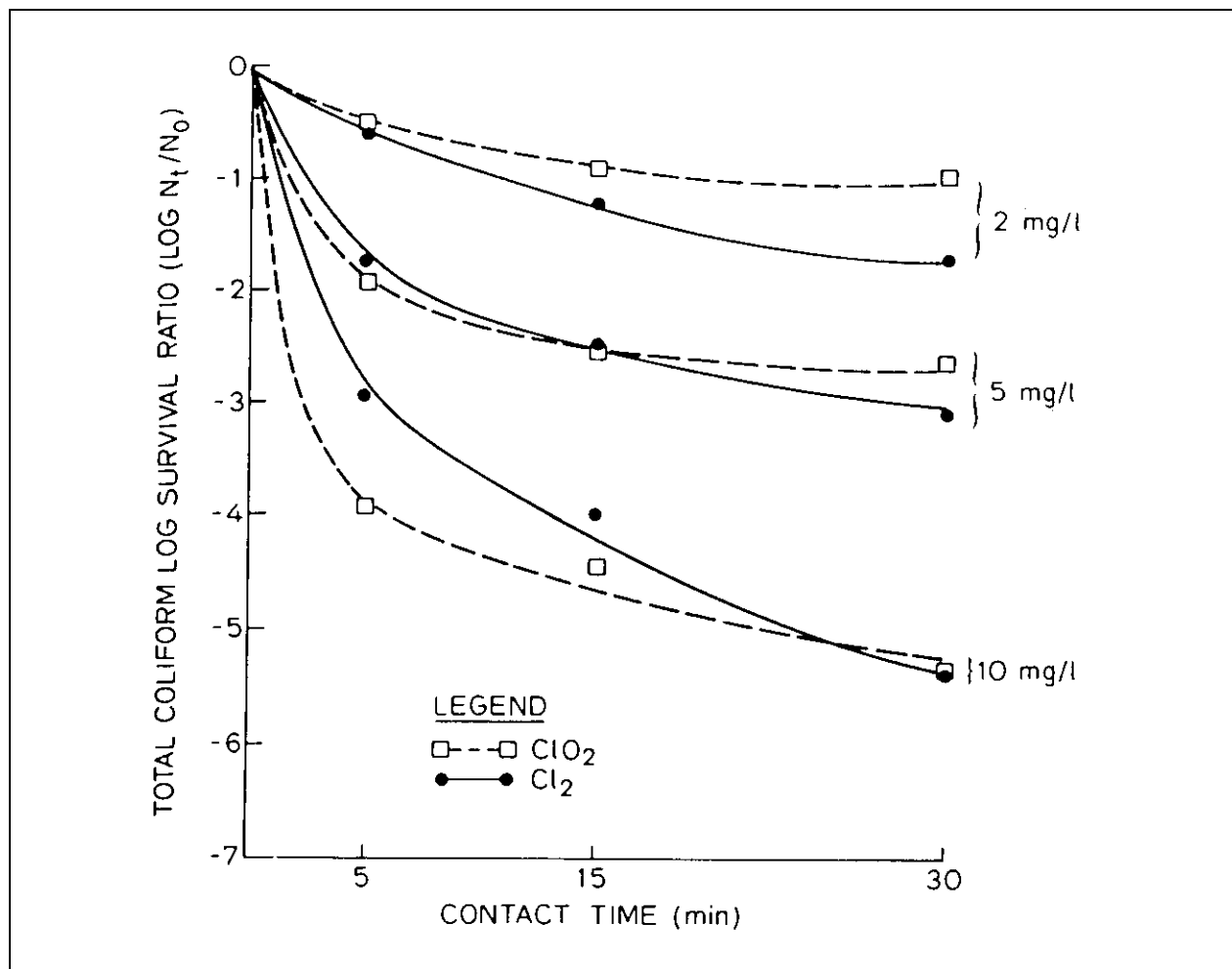
chlorine dioxide was effective against *E. coli* and *Bacillus anthracoides* at dosages in the range of 1 to 5 mg/L (Trakhtman, 1949). Ridenour and Armbruster (1949) reported that an orthotolidine arsenite (OTA) chlorine dioxide residual of less than 1 mg/L was effective against *Eberthella typhosa*, *Shigella dysenteriae*, and *Salmonella paratyphi* B. Under similar pH and temperature slightly greater OTA residuals were required for the inactivation of *Pseudomonas aeruginosa* and *Staphylococcus aureus*.

Chlorine dioxide was shown to be more effective than chlorine at inactivating *B. subtilis*, *B. mesentericus*, and *B. megatherium* spores (Ridenour et al., 1949). Moreover, chlorine dioxide was shown to be just as effective or more effective than chlorine at inactivating *Salmonella typhosa* and *S. paratyphi* (Bedulivich et al., 1954).

In the early 1960s several important contributions were made by Bernarde et al. (1967a and 1967b). Chlorine dioxide was found to be more effective than chlorine at disinfecting sewage effluent and the rate of inactivation was found to be rapid.

A comprehensive investigation of chlorine dioxide as disinfectant was performed by Roberts et al. (1980). The investigation was performed using secondary effluents from three different wastewater treatment plants. One of the objectives was to determine the relationships between dosages and contact times and bactericidal efficiency. Dosages were compared for 2, 5, and 10 mg/L of chlorine dioxide and chlorine. The contact times selected were 5, 15 and 30 minutes. Results of the investigation are shown in Figure 4-4. As shown, chlorine dioxide demonstrated a more rapid coliform inactivation than chlorine at the shortest contact time of 5 minutes and higher concentrations. However, after 30 minutes of contact time, chlorine dioxide was equal or slightly less efficient than chlorine as a bactericide.

Oliveri et al. (1984) studied the effectiveness of chlorine dioxide (and chlorine) residuals in inactivating total coliform and f2 coliphage virus in sewage introduced to a water distribution system. Initial chlorine dioxide residuals between 0.85 and 0.95 mg/L resulted in an average 2.8-log inactivation of the total coliform and an average 4.4-log inactivation of the f2 coliphage virus, over a contact time of 240 minutes.



Source: Roberts et al., 1980.

**Figure 4-4. Comparison of Germicidal Efficiency of Chlorine Dioxide and Chlorine**

#### 4.4.3.2 Protozoa Inactivation

The disinfection efficiency of chlorine dioxide has been shown to be equal to or greater than chlorine for *Giardia* inactivation. Based on a 60 minute contact time, chlorine dioxide doses in the range of 1.5 to 2 mg/L are capable of providing a 3-log *Giardia* inactivation at 1°C to 25°C and pHs of 6 and 9 (Hofmann et al., 1997). Depending on the temperature and pH, *Cryptosporidium* has been found to be 8 to 16 times more resistant to chlorine dioxide than *Giardia* (Hofmann et al., 1997). Although some *Cryptosporidium* oocysts remained viable, one group of researchers found that a 30-minute contact time with 0.22 mg/L chlorine dioxide could significantly reduce oocyst infectivity (Peeters et al., 1989). In contrast, other researchers have found that CT values in the range of 60 to 80 mg·min/L were necessary to provide 1- to 1.5-log inactivation (Korich et al., 1990; Ransome et al., 1993). Finch et al. (1995) reported that the CT values for 1-log inactivation was in the range of 27 to 30 mg·min/L. For 2-log inactivation, the CT value was approximately 40 mg·min/L, and 70 mg·min/L for 3-log inactivation. Finch et al. (1997) found 3-log inactivation of *Cryptosporidium* oocysts with initial chlorine dioxide residual concentrations of 2.7 and 3.3 mg/L for contact times of 120 minutes, at pH of 8.0 and a temperature of 22°C.

Both Chen et al. (1985) and Sproul et al. (1983) have investigated the inactivation of *Naegleria gruberi* cysts by chlorine dioxide. Both studies concluded that chlorine dioxide is an excellent disinfectant against cysts and that chlorine dioxide is better than or equal to chlorine in terms of inactivation. Chlorine dioxide was found to be superior to chlorine at higher pHs. However, the authors cautioned that the CT required for 2-log inactivation was much higher than normally employed for water treatment at that time.

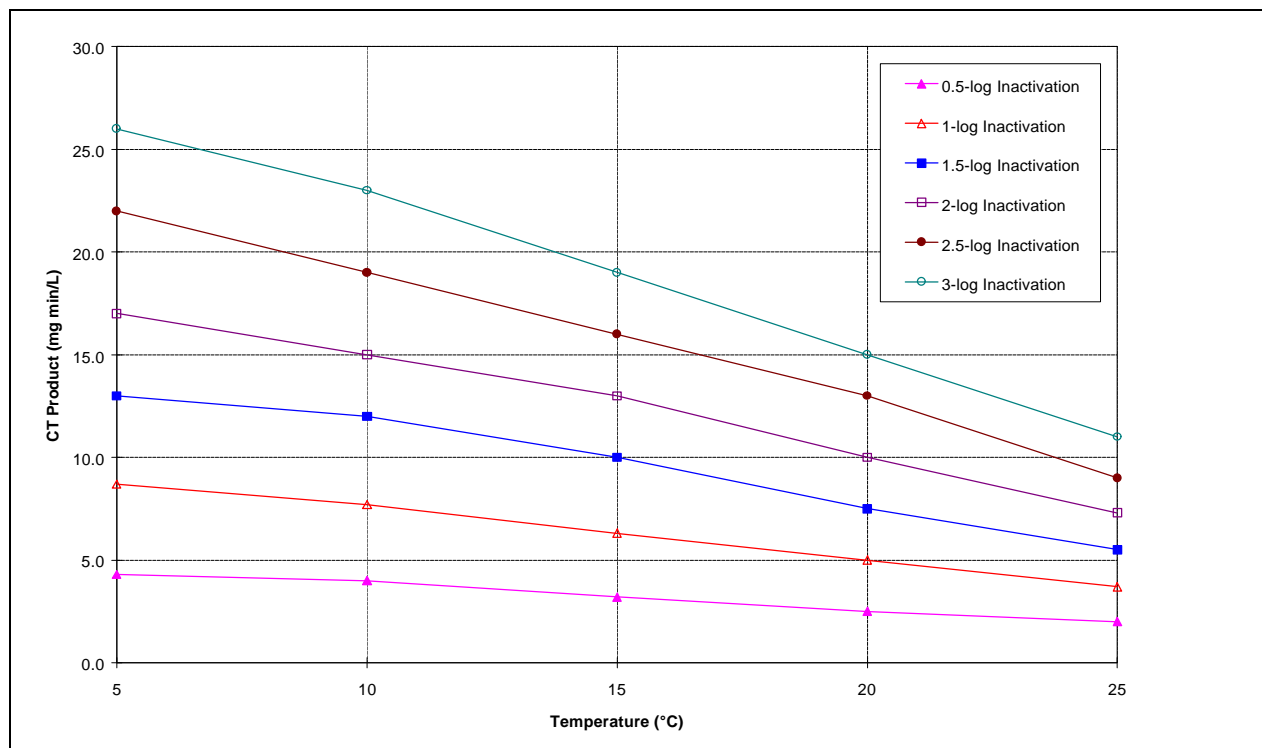
#### **4.4.3.3 Virus Inactivation**

Chlorine dioxide has been shown to be an effective viricide. Laboratory studies have shown that inactivation efficiency improves when viruses are in a single state rather than clumped. It was reported in 1946 that chlorine dioxide inactivated *Poliomyelitis* (Ridenour and Ingols, 1946). This investigation also showed that chlorine dioxide and free chlorine yielded similar results. Other studies have verified these findings for poliovirus 1 (Cronier et al., 1978) and *Coxsackie* virus A9 (Scarpino, 1979). At greater than neutral pHs (where hypochlorite ion is the predominant species) chlorine dioxide has been found to be superior to chlorine in the inactivation of numerous viruses such as echovirus 7, coxsackie virus B3, and sendai virus (Smith and McVey, 1973). Sobsey (1998) determined CT values based on a study of Hepatitis A virus, strain HM 175. The study found 4-log inactivation levels are obtainable at CT values of less than 35 at 5°C and less than 10 at a temperature of 25°C.

#### **4.4.3.4 CT Values**

Chlorine dioxide is regarded as a strong disinfectant that is effective at inactivating bacterial, viral, and protozoan pathogens. CT values for *Giardia* and virus inactivation are shown in Figure 4-5 and Figure 4-6, respectively (AWWA, 1991).

CT values shown in Figure 4-5 are based on disinfection studies using in vitro excystation of *Giardia muris*. Average CT values for 2 log removal were extrapolated using first order kinetics and multiplied by a safety factor of 1.5 to obtain the CT values for other log removal CT values. Due to the limited amount of data available at pH values other than 7, the same CT values are used for all pHs. Because chlorine dioxide is more effective at a pH 9 than at a pH of 7, the CT values shown in Figure 4-5 are more conservative for higher pHs than for lower pHs. A lower safety factor was used to derive the CT values for chlorine dioxide than for ozone due to the fact that the chlorine dioxide values were derived from *Giardia muris* studies, which are more resistant than *Giardia lamblia*.

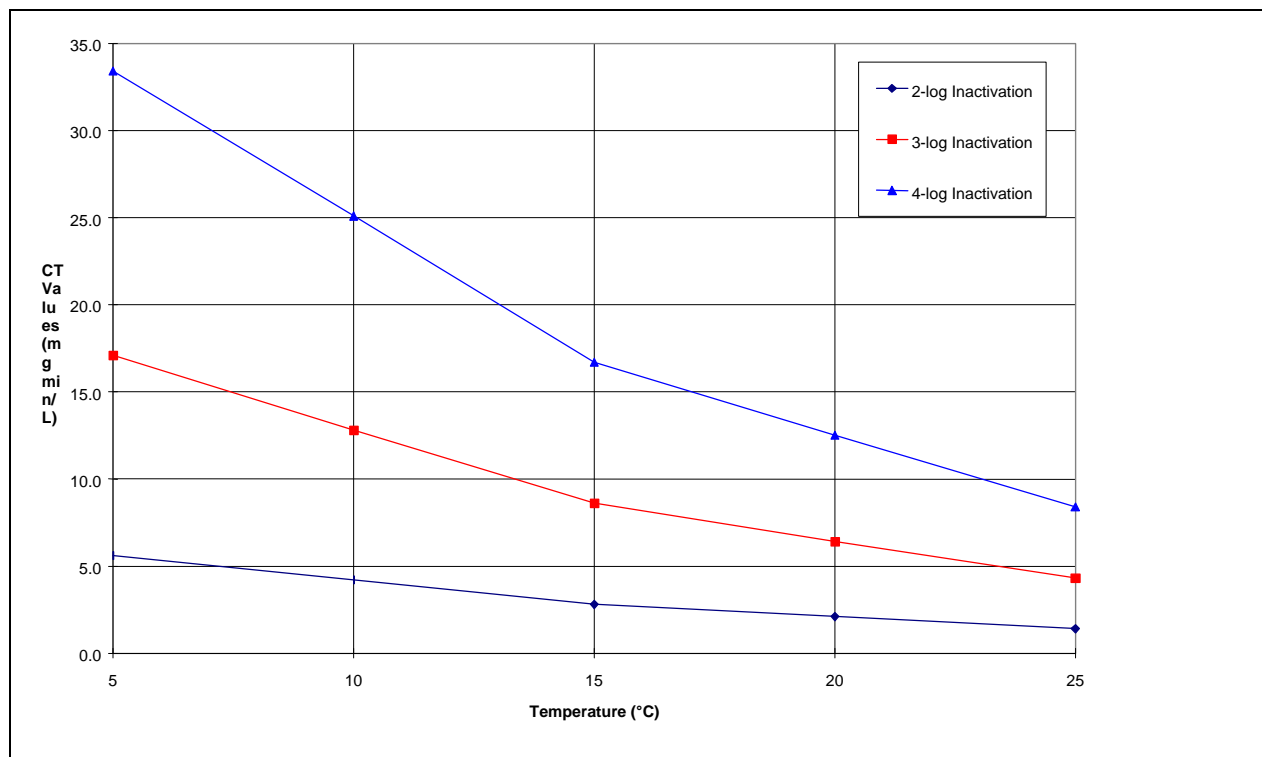


Source: AWWA, 1991.

**Figure 4-5. CT Values for Inactivation of *Giardia* Cysts by Chlorine Dioxide**

CT values shown in Figure 4-6 were obtained by applying a safety factor 2 to the average CT values derived from the studies on hepatitis A virus, strain HM 175 (Sobsey, 1988). CT values at temperatures other than 5°C were derived by applying a twofold decrease for every 10°C increase in temperature.

Figure 4-7 and Figure 4-8 show the relationship between CT products and log inactivation of *Cryptosporidium* at 20 and 10°C, respectively, and pHs of 6 and 8. CT values shown in Figure 4-7 and Figure 4-8 indicate that oocysts were more rapidly inactivated at pH 8 than 6 and that temperature does impact the disinfection efficiency of chlorine dioxide. Reducing the temperature from 20 to 10°C reduced the disinfection effectiveness by 40 percent. Finch (1997) is studying *Cryptosporidium* inactivation under laboratory conditions using a variety of different disinfectants, one of which is chloride dioxide.



Source: AWWA, 1991.

**Figure 4-6. CT Values for Inactivation of Viruses by Chlorine Dioxide**

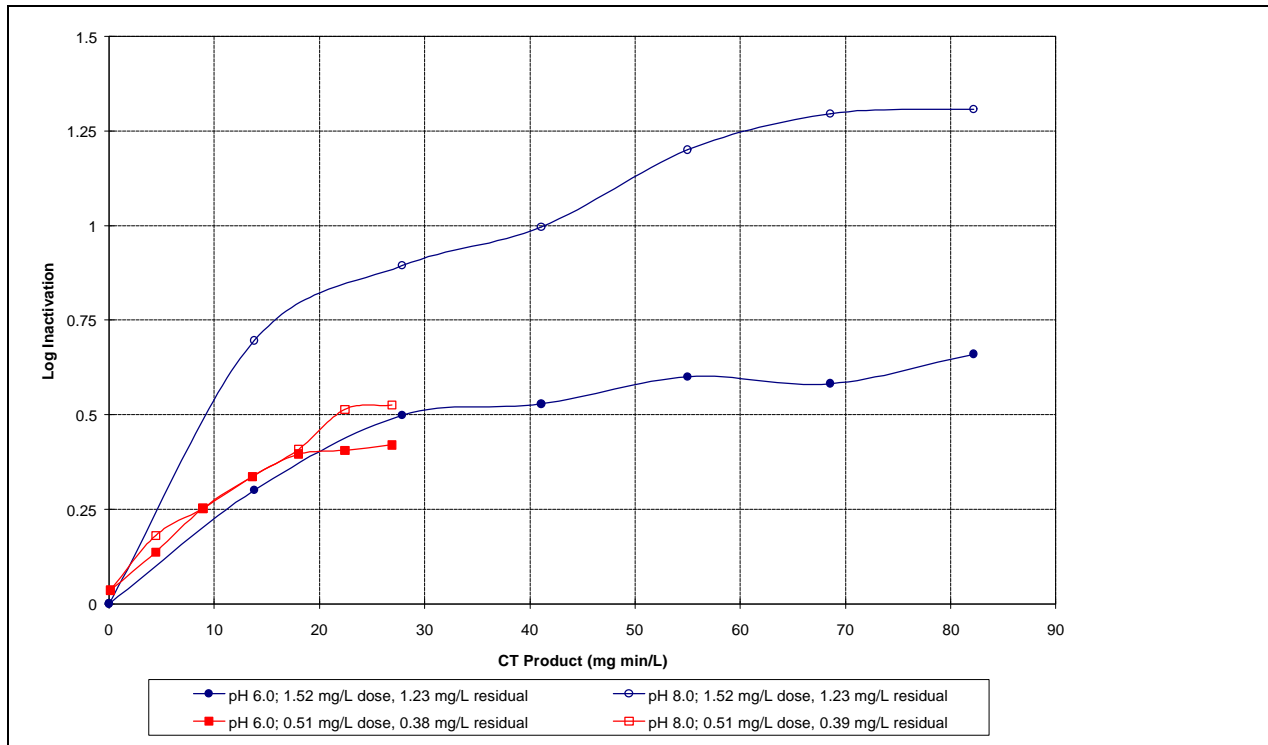
## 4.5 Chlorine Dioxide Disinfection Byproducts

Byproducts from the use of chlorine dioxide include chlorite, chlorate, and organic DBPs. This section discusses the formation of these byproducts and methods to reduce or remove these DBPs. The use of chlorine dioxide aids in reducing the formation of TTHMs and HAAs by oxidizing precursors, and by allowing the point of chlorination to be moved farther downstream in the plant after coagulation, sedimentation, and filtration have reduced the quantity of NOM.

### 4.5.1 Production of Chlorite and Chlorate

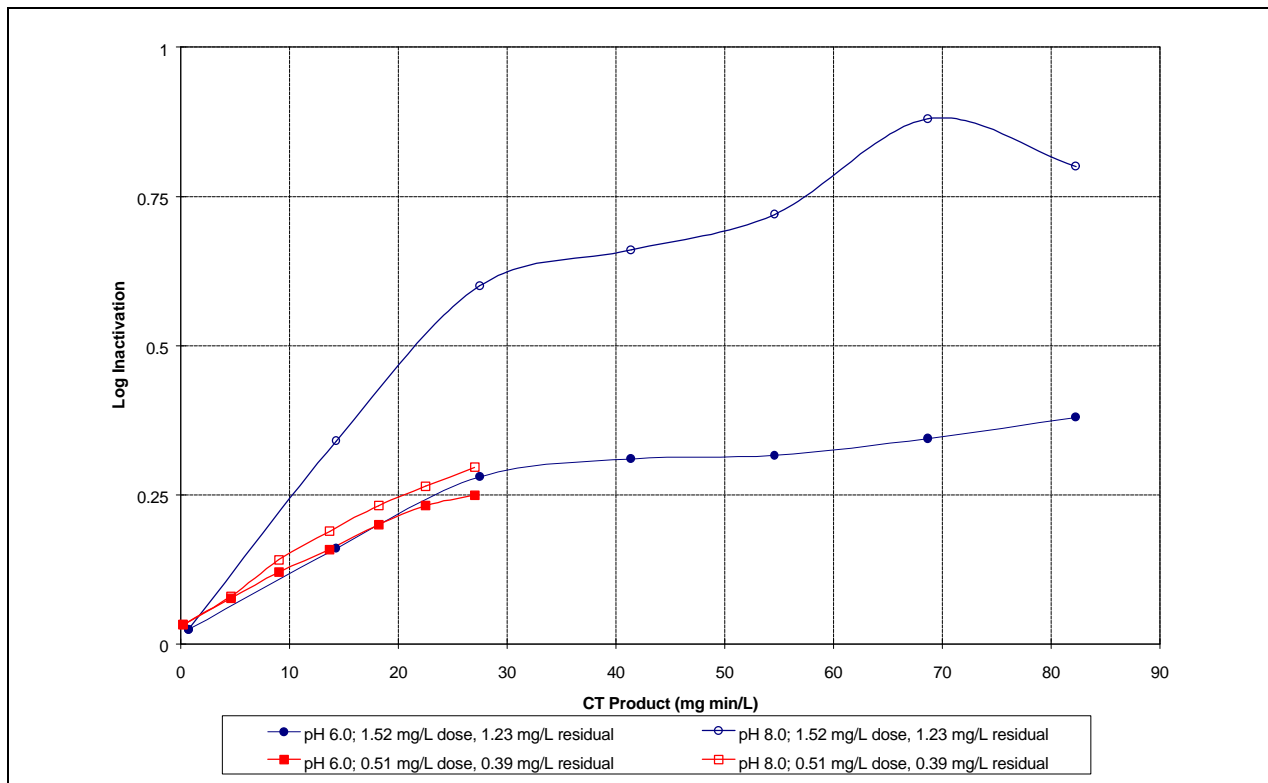
Chlorite and chlorate are produced in varying ratios as endproducts during chlorine dioxide treatment and subsequent degradation. The primary factors affecting the concentrations of chlorine dioxide, chlorite, and chlorate in finished drinking water involve:

- Dosage applied/oxidant demand ratio.
- Blending ratios of sodium chlorite and chlorine during the chlorine dioxide generation process.
- Exposure of water containing chlorine dioxide to sunlight.



Source: LeChevallier et al., 1996.

**Figure 4-7. *C. parvum* Inactivation by Chlorine Dioxide at 20°C**



Source: LeChevallier et al., 1996.

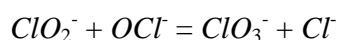
**Figure 4-8. *C. parvum* Inactivation by Chlorine Dioxide at 10°C**

- Reactions between chlorine and chlorite if free chlorine is used for distribution system residual maintenance.
- Levels of chlorate in sodium chlorite feedstock.

Incomplete reaction or non-stoichiometric addition of the sodium chlorite and chlorine reactants can result in unreacted chlorite in the chlorine dioxide feed stream. Dilute chlorine dioxide solutions are stable under low or zero oxidant-demand conditions. The quantity of chlorate produced during the chlorine dioxide generation process is greater with excess chlorine addition. Likewise, a low or high pH can increase the quantity of chlorate during the chlorine dioxide generation process. See Section 4.2, "Generation," for a detailed discussion of the chemistry of chlorine dioxide generation.

Numerous inorganic and biological materials found in raw water will react with chlorine dioxide (Noack and Doerr, 1977). Chloride ( $\text{Cl}^-$ ) and chlorite ( $\text{ClO}_2^-$ ) ions are the dominant degradation species arising from these reactions, although chlorate ( $\text{ClO}_3^-$ ) can appear for a variety of reasons when chlorine dioxide is used (Gordon et al., 1990; Werdehoff and Singer, 1987). The immediate redox reactions with natural organic matter play the dominant role in decay of chlorine dioxide into chlorite in drinking water (Werdehoff and Singer, 1987). Chlorite ion is generally the primary product of chlorine dioxide reduction. The distribution of chlorite and chlorate is influenced by pH and sunlight. Approximately 50 to 70 percent of the chlorine dioxide consumed by oxidation reactions is converted to chlorite under conditions typical in water treatment (Rav-Acha et al., 1984; Werdehoff and Singer, 1987). The application of 2 mg/L chlorine dioxide is expected to produce 1 to 1.4 mg/L of chlorite (Singer, 1992).

Chlorite is relatively stable in the presence of organic material but can be oxidized to chlorate by free chlorine if added as a secondary disinfectant (Singer and O'Neil, 1987).



Chlorate is therefore produced through the reaction of residual chlorite and free chlorine during secondary disinfection.

In addition, chlorine dioxide also disproportionates under highly alkaline conditions ( $\text{pH} > 9$ ) to chlorite and chlorate according to the following reaction:



In water treatment processes that require high pH, such as softening, chlorine dioxide should be added after the pH has been lowered (Aieta et al., 1984).

The occurrence of photochemical decomposition of chlorine dioxide can affect the ultimate concentrations of chlorine dioxide, chlorite, and chlorate in water treated with chlorine dioxide. Moreover, generally, sunlight may increase chlorate concentrations in uncovered storage basins containing water with chlorine dioxide residuals. Exposure to ultraviolet light will also change the potential reactions between chlorine dioxide and the bromide ion.

## 4.5.2 Organic DBPs Produced by Chlorine Dioxide

Chlorine dioxide generally produces few organic DBPs. However, Singer (1992) noted that the formation of non-halogenated organic byproducts of chlorine dioxide has not been adequately researched, and expected that chlorine dioxide will produce the same types of oxidation byproducts that are produced through ozonation. The application of chlorine dioxide does not produce THMs and produces only a small amount of total organic halide (TOX) (Werdehoff and Singer, 1987).

A study was conducted in 1994 by Richardson et al., to identify semivolatile, organic DBPs produced by chlorine dioxide treatment in drinking water. Samples were taken from a pilot plant in Evansville, Indiana that included the following treatment variations:

- Aqueous chlorine dioxide;
- Aqueous chlorine dioxide, ferrous chloride, ( $\text{FeCl}_2$ ), chlorine ( $\text{Cl}_2$ ), and dual media filtration (sand and anthracite);
- Gaseous chlorine dioxide; and
- Gaseous chlorine dioxide, ferrous chloride ( $\text{FeCl}_2$ ), chlorine ( $\text{Cl}_2$ ), and dual media filtration (sand and anthracite).

Using multispectral identification techniques, more than 40 different DBPs (many at sub-nanogram/L [ng/L] levels) were identified including carboxylic acids and maleic anhydrides isolated from XAD<sup>TM</sup> concentrates, some of which may be regulated in the Stage 2 DBPR. THMs were not found after chlorine dioxide was added to the water; however, THMs did show up during subsequent chlorination.

## 4.5.3 Chlorine Dioxide DBP Control Strategies

EPA recommends that the total concentration of chlorine dioxide, chlorite, and chlorate be less than 1.0 mg/L as  $\text{Cl}_2$  (USEPA, 1983). In addition, chlorine dioxide concentrations exceeding 0.4 to 0.5 mg/L contribute to taste and odor problems (AWWA, 1990). Due to these issues, the use of chlorine dioxide to provide a disinfectant residual is somewhat limited in moderate to high TOC water. In low oxidant-demand water, however,  $\text{ClO}_2$  residuals may last several days.

Once formed, chlorate is stable in finished drinking water. No known treatment exists for removing chlorate once it is formed. However, three strategies (Gallagher et al., 1994) that have been proven effective for chlorite removal are:

- Adding reduced-sulfur compounds such as sulfur dioxide and sodium sulfite (not recommended).
- Applying either granular activated carbon (GAC) or powdered activated carbon (PAC).
- Adding reduced iron salts, such as ferrous chloride and ferrous sulfate.

Chlorite removal from drinking water through sulfur dioxide and other sulfur-based reducing agents has been reported effective, but not desirable. A study of chlorite removal by sulfur dioxide indicates that a lower pH level yields higher chlorite removal, and chlorite removal efficiencies increase as the sulfur dioxide dose increases. Unfortunately, this removal process forms significant levels of chlorate when sulfur dioxide and metarsulfite are utilized. Therefore, it is concluded that treatment with sulfur dioxide and metarsulfite is not desirable for chlorite removal (Dixon and Lee, 1991). In addition, sodium thiosulfate results in effective chlorite reduction, but the degree of removal is highly dependent upon pH and contact time and relatively high dosages are required. Again, this application of sodium thiosulfate is not desirable because the required dosages are too high (Griese et al., 1991).

The addition of ferrous iron in drinking water is effective for chlorite removal, with chloride the expected byproduct. Chlorite reduction occurs quickly in the pH range of 5 to 7, and complete reduction occurs within 3 to 5 seconds. Excess reduced iron remaining in solution reacts with dissolved oxygen at neutral pH, but under acidic conditions (pH < 6.5) the stability of the soluble iron can create aesthetic (staining) problems if excess iron is used. Special consideration should be given to ferrous iron dosage requirements so that the secondary MCL for iron is not exceeded (Knocke and Iatrou, 1993).

Chlorite can be controlled by PAC at relatively high dosages (10 to 20 mg/L) and low pHs (5.5 to 6.5). Unless PAC is used for other purposes, such as odor control, it requires large doses and is not cost effective. PAC brands can differ in their capacity to reduce chlorite.

GAC can remove chlorite but breakthrough may occur relatively early. The removal of chlorite by GAC appears to be a result of adsorption and chemical reduction (Dixon and Lee, 1991). There is an initial high removal efficiency due to chlorite adsorption. As the adsorptive sites are occupied, chemical reduction on the GAC surface becomes the primary removal mechanism. This results in an initial high removal efficiency. Although chlorite levels exiting the GAC filters are low, the chlorate levels are high, most likely a result of reactions in the GAC filters between chlorite and free chlorine. According to studies, the capacity of GAC beds is low, and if free chlorine and chlorite ion are present in the GAC influent, chlorate ion will form. The most effective way to operate GAC for chlorite reduction and avoid chlorate is to minimize production run times and have no chlorine present in the filter.

## 4.6 Status of Analytical Methods

In addition to the monitoring requirements that apply regardless of the disinfectant used, the DBPR requires that water systems that use chlorine dioxide for disinfection or oxidation must also monitor their system for chlorine dioxide and chlorite.

### 4.6.1 Chlorine Dioxide and Chlorite Analytical Methods

For compliance monitoring for chlorine dioxide, systems must use one of the two methods specified in 40 CFR §141.131(c), including (1) DPD, Standard Method 4500-CLO<sub>2</sub> D, or (2) Amperometric Method II, Standard Method 4500-CLO<sub>2</sub> E. Where approved by the state, systems may also measure residual disinfectant concentrations for chlorine dioxide by using DPD colorimetric test kits.

For compliance monitoring for chlorite, systems must use one of the three methods specified in 40 CFR §141.131(b), including (1) Amperometric Titration, Standard Method 4500-CLO<sub>2</sub> E, (2) Ion Chromatography, EPA Method 300.0, or (3) Ion Chromatography, EPA Method 300.1. The regulations specify that Amperometric Titration may be used for routine daily monitoring of chlorite at the entrance to the distribution system, but that Ion Chromatography must be used for routine, monitoring of chlorate and monthly additional monitoring of chlorate in the distribution system.

Details of these analytical procedures can be found in:

- *Standard Methods for the Examination of Water and Wastewater*, 19<sup>th</sup> Edition, American Public Health Association, 1995.
- *Methods for the Determination of Inorganic Substances in Environmental Samples*. USEPA. 1993. EPA/600/R-93/100.
- *USEPA Method 300.1, Determination of Inorganic Anions in Drinking Water by Ion Chromatography, Revision 1.0*. USEPA. 1997. EPA/600/R-98/118.

Table 4-3 summarizes the analytical methods approved for use for chlorine dioxide and chlorite and provides some background information for each method.

### 4.6.2 Chlorine Dioxide Monitoring for Systems Using Chlorine Dioxide

For chlorine dioxide monitoring, community, non-transient non-community, and transient non-community water systems that use chlorine dioxide for disinfection or oxidation, are required to take daily samples at the entrance to the distribution system. For any daily sample that exceeds the chlorine dioxide MRDL of 0.8 mg/L, the system must take additional samples in the distribution system the following day at the locations specified in the DBPR, in addition to the daily sample required at the entrance to the distribution system.

Additional sampling is to be performed in one of two ways, depending on the disinfectant that is used to maintain a disinfectant residual in the distribution system. If chlorine dioxide or chloramines are used to maintain a disinfectant residual, or if chlorine is used to maintain the residual and there are no disinfection addition points after the entrance to the distribution system (i.e., no booster chlorination), the system must take three samples as close to the first customer as possible, at intervals of at least six hours. If chlorine is used to maintain a disinfectant residual and there are one or more disinfection addition points after the entrance to the distribution system, the system must take one sample at each of the following locations: (1) as close to the first customer as possible, (2) in a location representative of average residence time,

and (3) as close to the end of the distribution system as possible (reflecting maximum residence time in the distribution system). Chlorine dioxide monitoring may not be reduced.

If any daily sample taken at the entrance to the distribution system exceeds the MRDL, and on the following day one (or more) of the three samples taken in the distribution system exceed the MRDL, the system is in violation of the MRDL. The system must take immediate corrective action to lower the level of chlorine dioxide below the MRDL, and must notify the public of the acute violation pursuant to 40 CFR §141.32. The system must also report to the State pursuant to 40 CFR §141.134.

If any two consecutive daily samples taken at the entrance to the distribution system exceed the MRDL, the system is also in violation of the MRDL and must notify the public of the non-acute violation pursuant to 40 CFR §141.32. The system must also report to the State pursuant to 40 CFR §141.134.

### **4.6.3 Chlorite Monitoring for Systems Using Chlorine Dioxide**

For chlorite monitoring, community and non-transient non-community water systems that use chlorine dioxide for disinfection or oxidation are required to take daily samples at the entrance to the distribution system. For any daily sample that exceeds the chlorite MCL of 1.0 mg/L, the system must take additional samples in the distribution system the following day at the locations specified in the DBPR. These additional samples are to be collected at: (1) a location as close to the first customer as possible, (2) a location representative of average residence time, and (3) a location as close to the end of the distribution system as possible (reflecting maximum residence time in the distribution system).

In addition, systems using chlorine dioxide must take a three-sample set each month in the distribution system similar to the three locations required if the chlorite MCL is exceeded in the sample collected at the entrance to the distribution system. Specifically, these three-sample sets are to be collected: (1) in a location near the first customer, (2) in a location representative of average residence time, and (3) at a location reflecting maximum residence time in the distribution system. Any additional routine sampling must be conducted in the same three-sample sets at the specified locations. This monthly sampling requirement may be reduced to quarterly after one year of monitoring where: (1) no individual chlorite sample taken in the distribution system has exceeded the MCL and (2) the system has not been required to conduct follow-up monitoring as a result of a daily sample collected at the entrance to the distribution system. These systems can remain on an annual schedule until either the daily sample or any of the three individual quarterly samples exceed the MCL, at which time, the system must revert to monthly monitoring.

If the arithmetic average of any three-sample set exceeds the chlorite MCL of 1.0 mg/L, the system is in violation of the MCL and must notify the public pursuant to 40 CFR §141.32, in addition to reporting to the State pursuant to 40 CFR §141.134.

## **4.7 Operational Considerations**

As with all disinfectant selections, the primacy agency should be consulted when selecting disinfectants. Certain states have their own operational, maintenance, and monitoring requirements

for the application of chlorine dioxide. California prohibits the use of chlorine dioxide in ground water systems, according to Merkle et al., 1997. Also, in Texas, the Texas Natural Resources Conservation Commission (TNRCC) requires the public water supply to sign a bilateral agreement which outlines a detailed operator qualifications requirement, testing methods, and procedures, monitoring locations, testing frequency and reporting procedures. The chlorine dioxide concentration leaving the water treatment plant must be less than 0.8 mg/L and the chlorite concentration in the distribution system must be less than 1.0 mg/L.

State requirements must be reviewed to determine the cost-effectiveness of utilizing chlorine dioxide as part of the overall water treatment scheme. Analytical testing and reporting requirements may have significant labor and cost impacts.

**Table 4-3. Analytical Methods for Chlorine Dioxide and Related Compounds**

Method	Basis	Interferences	Limits
DPD as Test Kits Colorimetric (SM-4500-ClO <sub>2</sub> G)	Colored oxidation product. Use of color comparator is not recommended. Use instrument detection.	Mn <sup>2+</sup> , other Cl <sub>2</sub> , related oxidants.	> 0.1 mg/L
DPD-glycine Method Colorimetric (SM 4500- ClO <sub>2</sub> .D)	Colored product, free Cl <sub>2</sub> is masked with glycine as chloraminacetic acid.	ClO <sub>2</sub> slowly; other oxidants.	> 0.1 mg/L
DPD-FAS Titrimetric method (SM 4500- ClO <sub>2</sub> .D)	DPD color titration with standard FAS until red color is discharged.	Iron, other oxidants.	> 0.1 mg/L
5-Step Amperometric Method 4500-ClO <sub>2</sub> .E	I <sup>-</sup> oxidation; pH control and gas purging steps. Skilled analyst needed.	Suitable for ClO <sub>2</sub> generated solution. Low levels not okay.	~ PQL ClO <sub>2</sub> : 0.1-0.05 mg/L; ClO <sub>3</sub> <sup>-</sup> at 0.5 mg/L
Ion Chromatography (EPA Method 300.0 or 300.1) Conductivity	Must use AS9 column, ext. standards & suppression.	No other oxidants. Chloramines, ClO <sub>2</sub> , OCl <sup>-</sup> & HOCl undetectable.	~ 0.05 mg/L
Two-step Amperometric Method 4500-ClO <sub>2</sub> .E	I <sup>-</sup> Oxidation; pH control. Amendable to operator-based dosage control. Practical method.	Cu <sup>2+</sup> , Mn <sup>2+</sup> , NO <sub>2</sub> <sup>-</sup> Accounts for free Cl <sub>2</sub> , NH <sub>2</sub> Cl, ClO <sub>2</sub> species.	> 0.1 mg/L, not ClO <sub>3</sub> <sup>-</sup>

Source: Gates, 1998.

Notes: SM = Standard Methods

### 4.7.1 Process Considerations

The basic components of chlorine dioxide generation systems include:

- Aqueous hypochlorite solution storage and feed system;
- Sodium chlorite storage and feed system;
- Acid storage and feed system (for Direct-Acidification generators);
- Chlorine storage and feed system;
- Chlorine dioxide generator; and
- Chlorine dioxide feed piping and dispersion equipment.

Sodium chlorite storage and feed systems are basically liquid systems that consist of a storage tank(s) and solution feed pumps. Outside storage of 25 percent solutions (or greater) of sodium chlorite is not recommended in cold climates since stratification may occur below 4°C (40°F). Any ice formation may also damage the storage tanks. In some cases, storage might be separated into bulk tanks and smaller operational or day tanks that are filled periodically. Storage of dark drums for long periods in hot climates should be avoided since sodium chlorite decomposition will occur. In the storage area, light fixtures, switches, wiring, and conduit runs should be located to avoid the risk of sodium chlorite spilling on them.

## 4.7.2 Generator Operation

A manual chlorine dioxide feed system may be used where the chlorine dioxide dose remains fairly constant. The reagent chemicals are manually set for the desired chlorine dioxide capacity at a ratio of chemicals optimized for maximum chlorine dioxide yield. Some generating systems can produce 95 percent pure chlorine dioxide solutions at full design capacity, but purity can vary when the feed rate is changed. Turndown capacity may be limited by precision of the flow metering devices, typically 20 percent of rate capacity. Purity can vary when the feed rate is changed significantly. Feed water alkalinity, operating conditions, and pH also can affect yield. The ratio of reagent chemicals should be routinely adjusted for optimum operation. Chlorine dioxide generators can be provided with automated control to provide modulation of chlorine dioxide feed rates based upon changes in flow (flow paced) and chlorine dioxide demand (residual control). The automatic modulation of the generators to meet a demand setpoint varies with manufacturer. Generally, vacuum and combination systems are limited by the hydraulic requirements of the venturi and the optimum reaction conditions for chlorine dioxide generation. A chemical metering pump or injector system is then used with a batch production system to control the applied dose of chlorine dioxide.

## 4.7.3 Feed Chemicals

Chlorine dioxide is generated when sodium chlorite is either oxidized or acidified, or both, under controlled pH and temperature conditions. Commonly, solutions of 25 percent active sodium chlorite or less are used in chlorine dioxide generators. The major safety concern for solutions of sodium chlorite is the unintentional and uncontrollable release of high levels of chlorine dioxide. Such levels may approach detonation or conflagration concentrations by accidental acidification.

The feedstock acid used by some of the generators is only one source of accidental chemical acidification. Accidental mixing with large amounts of any reducing agent or oxidizable material (such as powdered activated carbon or flammable solvents) also represents a significant hazard. The AWWA Standard B303-95 (a) includes an outline of some of these materials (AWWA, 1995).

Another concern when handling and storing sodium chlorite solutions is crystallization, which occurs as a result of lower temperatures and/or higher concentrations. Crystallization will plug pipelines, valves, and other equipment. Sodium chlorite solution should not be allowed to evaporate to a powder. If dried, this product becomes a fire hazard and can ignite in contact with combustible materials. A sodium chlorite fire may result in a steam explosion if too much water and inappropriate fire-fighting techniques are used to quench such a fire. As the temperature of burning sodium chlorite is around 2200°C, water quickly turns to steam. Because thermal breakdown products of sodium chlorite at high temperatures include molecular oxygen, appropriate techniques are required to correctly extinguish closed containers or large amounts of dry material that has been ignited.

Stratification of sodium chlorite in holding tanks may also occur and would influence the chlorine dioxide yield. If stratification occurs in the bulk tank, sodium chlorite changes from high density to

low density as it is fed. The density will continue to change until the material is re-mixed. In stratified tanks, excess chlorite would be fed to the generator since the bottom of the tank will have denser material, and this material would have more chlorite than required. Similarly, the bulk tank would later discharge too little chlorite.

Although infrequent, such stratification is not readily apparent and may likely remain unnoticed by operations unless the generator performance is evaluated frequently. If stratification or crystallization occurs in bulk delivery trucks, the entire content should be warmed prior to delivery so that the sodium chlorite is re-mixed. Operators should be aware of the possibility of stratification and crystallization during delivery conditions.

Sodium chlorite is commercially available as a 38 percent or 25 percent solution. Chemical and physical properties are given in Table 4-4.

**Table 4-4. Properties of Sodium Chlorite as Commercially Available**

	38% Solution*	25% Solution*
Sodium Chlorite, (%) NaClO <sub>2</sub>	38	25
Sodium Chloride, (%) NaCl	1.5-7.5	1-4.5
Inert Ingredients, mixture of other sodium salts (%)	3-4	3-4
Water (%)	55-61	68-74
Appearance	Slightly cloudy, pale yellow	Clear, pale yellow
Density @ 35°C (lb/gal), typical	11.4	10.1
Crystallization Point (°C)	25	-7

\* Source: Vulcan Chemicals

For systems handling the 38 percent solution, storage tanks, piping and pumps will require a heated enclosure, or heat tracing and insulation. The 25 percent solution may not require any special protection except in cold climates.

The ideal production of 1.0 pound of chlorine dioxide requires 0.5 pounds of chlorine and 1.34 pounds of pure sodium chlorite. Chlorine gas is available as a nearly 100 percent pure chemical on a weight basis. Gas flow metering devices are typically limited to +/- 5 percent accuracy at full rated capacity. For example, a 100 pound per day flow tube would allow between 20 and 30 pounds of chlorine to flow if set at 25 pounds per day (i.e., 25 +/- 5 percent of maximum flow capacity). Sodium chlorite is supplied commercially as a pre-mixed aqueous solution of various strengths. The 25 percent solution is the most commonly used grade for potable water treatment.

Pure chlorine dioxide solutions (very dark amber and oily in appearance) are very dangerous and are likely to detonate if exposed to oxidizable materials or vapors, or even to bright lights. They are extremely uncommon except perhaps in very specific laboratory setup systems using concentrated sodium chlorite and concentrated acid mixtures. Such laboratory generation methods are not

recommended for the uninitiated laboratory analyst or operator. Inexperienced personnel should not mix strong acid and strong sodium chlorite solutions together unless they are familiar with the purgeable extraction methods for sodium chlorite and have a safely designed setup under a fume hood.

## 4.8 Summary

### 4.8.1 Advantages and Disadvantages of Chlorine Dioxide Use

The following list highlights selected advantages and disadvantages of using chlorine dioxide as a disinfection method for drinking water (Masschelein, 1992; DeMers and Renner, 1992, Gallagher et al., 1994). Because of the wide variation of system size, water quality, and dosages applied, some of these advantages and disadvantages may not apply to a particular system.

#### Advantages

- Chlorine dioxide is more effective than chlorine and chloramines for inactivation of viruses, *Cryptosporidium*, and *Giardia*.
- Chlorine dioxide oxidizes iron, manganese, and sulfides.
- Chlorine dioxide may enhance the clarification process.
- Taste and odors resulting from algae and decaying vegetation, as well as phenolic compounds, are controlled by chlorine dioxide.
- Under proper generation conditions (i.e., no excess chlorine), halogen-substituted DBPs are not formed.
- Chlorine dioxide is easy to generate.
- Biocidal properties are not influenced by pH.
- Chlorine dioxide provides residuals.

#### Disadvantages

- The chlorine dioxide process forms the specific byproducts chlorite and chlorate.
- Generator efficiency and optimization difficulty can cause excess chlorine to be fed at the application point, which can potentially form halogen-substitute DBPs.
- Costs associated with training, sampling, and laboratory testing for chlorite and chlorate are high.
- Equipment is typically rented, and the cost of the sodium chlorite is high.
- Measuring chlorine dioxide gas is explosive, so it must be generated on-site.
- Chlorine dioxide decomposes in sunlight.
- Chlorine dioxide must be made on-site.
- Can lead to production noxious odors in some systems.

## 4.8.2 Summary Table

Table 4-5 summarizes considerations and descriptions for chlorine dioxide use.

**Table 4-5. Summary for Chlorine Dioxide**

Consideration	Description
Generation	Chlorine dioxide must be generated on-site. In most potable water applications, chlorine dioxide is generated as needed and directly added or injected into a diluting stream. Generators are available that utilize sodium chlorite and a variety of feedstocks such as Cl <sub>2</sub> gas, sodium hypochlorite, and sulfuric or hydrochloric acid. Small samples of generated solutions, up to 1 percent (10 g/L) chlorine dioxide can be safely stored if the solution is protected from light, chilled (<5°C), and has no unventilated headspace.
Primary Uses	Chlorine dioxide is utilized as a primary or secondary disinfectant, for taste and odor control, TTHM/HAA reduction, Fe and Mn control, color removal, sulfide and phenol destruction, and Zebra mussel control.
Inactivation Efficiency	Chlorine dioxide rapidly inactivates most microorganisms over a wide pH range. It is more effective than chlorine (for pathogens other than viruses) and is not pH dependent between pH 5-10, but is less effective than ozone.
Byproducts Formation	When added to water, chlorine dioxide reacts with many organic and inorganic compounds. The reactions produce chlorite and chlorate as endproducts (compounds that are suspected of causing hemolytic anemia and other health effects). Chlorate ion is formed predominantly in downstream reactions between residual chlorite and free chlorine when used as the distribution system disinfectant. Chlorine dioxide does not produce THMs. The use of chlorine dioxide aids in reducing the formation of TTHMs and HAAs by oxidizing precursors, and by allowing the point of chlorination to be moved farther downstream in the plant after coagulation, sedimentation, and filtration have reduced the quantity of NOM.
Point of Application	In conventional treatment plants, chlorine dioxide used for oxidation is fed either in the raw water, in the sedimentation basins, or following sedimentation. To limit the oxidant demand, and therefore chlorine dioxide dose and the formation of chlorite, it is common to add chlorine dioxide following sedimentation. Concerns about possible taste and odor complaints have limited the use of chlorine dioxide to provide a disinfectant residual in the distribution system. Consequently, public water suppliers that are considering the use of chlorine dioxide for oxidation and primary disinfectant applications may want to consider chloramines for secondary disinfection.
Special Considerations	An oxidant demand study should be completed to determine an approximate chlorine dioxide dosage to obtain the required CT value as a disinfectant. In addition to the toxic effects of chlorine, chlorine dioxide gas is explosive at levels > 10% in air. The chlorine dioxide dosage cannot exceed 1.4 mg/L to limit the total combined concentration of ClO <sub>2</sub> , ClO <sub>2</sub> <sup>-</sup> , ClO <sub>3</sub> <sup>-</sup> , to a maximum of 1.0 mg/L. Under the proposed DBP regulations, the MRDL for chlorine dioxide is 0.8 mg/L and the MCL for chlorite is 1.0 mg/L. Regulations concerning the use of chlorine dioxide vary from state-to-state.

## 4.9 References

1. Aieta, E., and J.D.Berg. 1986. "A Review of Chlorine Dioxide in Drinking Water Treatment." *J. AWWA*. 78(6):62-72.
2. Aieta, E.M., P.V. Roberts, and M. Hernandez. 1984. "Determination of Chlorine Dioxide, Chlorine and Chlorate in Water." *J. AWWA*. 76(1):64-70.
3. Alvarez, M.E. and R.T. O'Brien. 1982. "Mechanism of Inactivation of Poliovirus by Chlorine Dioxide and Iodine." *Appl. Envir. Microbiol.* 44:1064.
4. AWWA (American Water Works Association). 1995. AWWA Standard B303-95: Sodium Chlorite.
5. AWWA. 1991. *Guidance Manual for Compliance with the Filtration and Disinfection Requirements for Public Water Systems Using Surface Water Sources*.
6. AWWA. 1990. *Water Quality and Treatment*, fourth edition. McGraw-Hill, Inc., New York, NY.
7. Bedulivich, T.S., M.N. Svetlakova, and N.N. Trakhtman. 1954. "Use of Chlorine Dioxide in Purification of Water." *Chemical Abstracts*. 48:2953.
8. Bernarde, M.A., et al. 1967a. "Kinetics and Mechanism of Bacterial Disinfection by Chlorine Dioxide." *J. Appl. Microbiol.* 15(2):257.
9. Bernarde, M.A., W.B. Snow, and V.P. Olivieri. 1967b. "Chlorine Dioxide Disinfection Temperature Effects." *J. Appl. Bacteriol.* 30(1):159.
10. Chen, Y.S.R., O.J. Sproul, and A.J. Rubin. 1985. "Inactivation of *Naegleria gruberi* Cysts by Chlorine Dioxide." *Water Res.* 19(6):783.
11. Chen, Y.S.R., O.J. Sproul, and A.J. Rubin. 1984. "Inactivation of *Naegleria Gruberi* cysts by Chlorine Dioxide." EPA Grant R808150-02-0, Department of Civil Engineering, Ohio State University.
12. *CRC Handbook of Chemistry and Physics*. 1990. D.L. Lide (editor), Seventy-first edition, CRC Press, Boca Raton, FL.
13. Cronier, S., et al. 1978. *Water Chlorination Environmental Impact and Health Effects*, Vol. 2. R. L. Jolley, et al. (editors) Ann Arbor Science Publishers, Inc. Ann Arbor, MI.
14. Demers, L.D., and R. Renner. 1992. *Alternative Disinfectant Technologies for Small Drinking Water Systems*. AWWARF, Denver, CO.

15. Dixon, K.L. and R.G. Lee. 1991. "Disinfection By-Products Control: A Survey of American System Treatment Plants." Presented at AWWA Conference, Philadelphia, PA.
16. Emmenegger, F. and G. Gordon. 1967. "The Rapid Interaction Between Sodium Chlorite and Dissolved Chlorine." *Inorg. Chem.* 6(3):633.
17. Finch, G.R., L.R. Liyanage, M. Belosevic, and L.L. Gyürek. 1997. "Effects of Chlorine Dioxide Preconditioning on Inactivation of *Cryptosporidium* by Free Chlorine and Monochloramine: Process Design Requirements." Proceedings 1996 Water Quality Technology Conference; Part II. Boston, MA.
18. Finch, G.R., L.R. Liyanage, and M. Belosevic. 1995. "Effect of Disinfectants and *Cryptosporidium* and *Giardia*." Third International Symposium on Chlorine Dioxide: Drinking Water, Process Water, and Wastewater Issues.
19. Gallagher, D.L., R.C. Hoehn, A.M. Dietrich. 1994. *Sources, Occurrence, and Control of Chlorine Dioxide By-Product Residuals in Drinking Water*. AWWARF, Denver, CO.
20. Gates, D.J. 1998. *The Chlorine Dioxide Handbook; Water Disinfection Series*. AWWA Publishing, Denver, CO.
21. Gates, D.J. 1989. "Chlorine Dioxide Generation Technology and Mythology." Conference proceedings, Advances in Water Analysis and Treatment, AWWA, Philadelphia, PA.
22. Ghandbari, E. H., et al. 1983. "Reactions of Chlorine and Chlorine Dioxide with Free Fatty Acids, Fatty Acid Esters, and Triglycerides." *Water Chlorination: Environmental Impact and Health Effects*, R. L. Jolley, et al. (editors), Lewis, Chelsea, MI.
23. Gordon, G., G.L. Emmert, and B. Bubnis. 1995. "Bromate Ion Formation in Water When Chlorine Dioxide is Photolyzed in the Presence of Bromide Ion." Conference proceedings, AWWA Water Quality Technology Conference, New Orleans, LA.
24. Gordon, G., et al. 1990. "Minimizing Chlorite Ion and Chlorate Ion in Water Treated with Chlorine Dioxide." *J. AWWA*. 82(4): 160-165.
25. Gordon, G., W.J. Cooper, R.G. Rice, and G.E. Pacey. 1987. *Disinfectant Residual Measurement Methods*, AWWARF, Denver, CO.
26. Gordon, G., R.G. Kieffer, and D.H. Rosenblatt. 1972. "The Chemistry of Chlorine Dioxide." *Progress in Organic Chemistry*, vol. 15. S.J. Lippaer (editor). Wiley Interscience, New York, NY.
27. Great Lakes Upper Mississippi River Board of State Public Health (GLUMRB) and Environmental Managers. 1992. *Recommended Standards for Water Works*, Health Research Inc., Albany, NY.

28. Gregory, D. and K. Carlson. 1998. "Applicability of Chlorine Dioxide for Cryptosporidium Inactivation." Proceedings 1998 Water Quality Technology Conference, San Diego, CA.
29. Griese, M.H., K. Hauser, M. Berkemeier, and G. Gordon. 1991. "Using Reducing Agents to Eliminate Chlorine Dioxide and Chlorite Ion Residuals in Drinking Water." *J. AWWA*. 83(5):56.
30. Hoehn, R.C. 1992. "Chlorine Dioxide Use in Water Treatment: Key Issues." Conference proceedings, Chlorine Dioxide: Drinking Water Issues: Second International Symposium. Houston, TX.
31. Hoehn, R.C., A.A. Rosenblatt, and D.J. Gates. 1996. "Considerations for Chlorine Dioxide Treatment of Drinking Water." Conference proceedings, AWWA Water Quality Technology Conference, Boston, MA.
32. Hofman, R., R.C. Andrews, and Q. Ye. 1997. "Chlorite Formation When Disinfecting Drinking Water to *Giardia* Inactivation Requirements Using Chlorine Dioxide." Conference proceedings, ASCE/CSCE Conference, Edmonton, Alberta, July.
33. Knocke, W.R. and A. Iatrou. 1993. *Chlorite Ion Reduction by Ferrous Ion Addition*. AWWARF, Denver, CO.
34. Korich, D.G., et al. 1990. "Effects of Ozone, Chlorine Dioxide, Chlorine, and Monochloramine on *Cryptosporidium parvum* oocyst Viability." *Appl. Environ. Microbiol.* 56:1423-1428.
35. LeChevallier, M.W., et al. 1997. "Chlorine Dioxide for Control of *Cryptosporidium* and Disinfection Byproducts." Conference proceedings, 1996 AWWA Water Quality Technology Conference Part II, Boston, Massachusetts.
36. LeChevallier, M.W., et al. 1996. "Chlorine Dioxide for Control of *Cryptosporidium* and Disinfection Byproducts." Conference proceedings, AWWA Water Quality Technology Conference, Boston, Massachusetts.
37. Liyanage, L.R.J, et al. 1997. "Effects of Aqueous Chlorine and Oxychlorine Compounds on *Cryptosporidium Parvum* Oocysts." *Environ. Sci. & Tech.* 31(7): 1992-1994
38. Masschelein, W.J. 1992. "Unit Processes in Drinking Water Treatment." Marcel Decker D.C., New York, Brussels, Hong Kong.
39. Merkle, J.C. and C.B. Reeverts. 1997. "Ground Water Treatment: What Are the States Doing Now?" AWWARF, Denver, CO.
40. Noack, M.G. and R.L. Doerr. 1977. "Reactions of Chlorine, Chlorine Dioxide and Mixtures of Humic Acid: An Interim Report." Conference proceedings, Second Conference on the Environmental Impact of Water Chlorination. R.L. Jolley, H. Gorchev, and D. Heyward (editors), Gatlinburg, TN.

41. Noss, C.I., W.H. Dennis, V.P. Olivieri. 1983. "Reactivity of Chlorine Dioxide with Nucleic Acids and Proteins." *Water Chlorination: Environmental Impact and Health Effects*. R. L. Jolley, et al. (editors), Lewis Publishers, Chelsea, MI.
42. Olivieri, V.P., et al. 1985. "Mode of Action of Chlorine Dioxide on Selected Viruses." *Water Chlorination: Environmental Impact and Health Effects*. R. L. Jolley, et al. (editors), Lewis, Chelsea, MI.
43. Olivieri, V.P., et al. 1984. Stability and Effectiveness of Chlorine Disinfectants in Water Distribution Systems. USEPA, Cincinnati, OH.
44. Peeters, J. E. et al. 1989. "Effect of Disinfection of Drinking Water with Ozone or Chlorine Dioxide on Survival of *Cryptosporidium parvum* oocysts." *Appl. Environ. Microbiol.* 55:1519-1522.
45. Pitochelli, A. 1995. "Chlorine Dioxide Generation Chemistry." Conference proceedings, Third International Symposium, Chlorine Dioxide: Drinking Water, Process Water, and Wastewater Issues. New Orleans, LA.
46. Ransome, M.E., T.N. Whitmore, and E.G. Carrington. 1993. "Effect of Disinfectants on the Viability of *Cryptosporidium parvum* Oocysts." *Water Supply*. 11(1):103-117.
47. Rav-Acha, C., A. Serri, E. Choshen, B. Limoni. 1984. "Disinfection of Drinking Water Rich in Bromide with Chlorine and Chlorine Dioxide, While Minimizing the Formation of Undesirable Byproducts." *Wat. Sci. Technol.* 17:611.
48. Richardson, S.D. et al. 1994. "Multispectral Identification of ClO<sub>2</sub> Disinfection Byproducts in Drinking Water." *Environ. Sci. & Technol.* 28(4):592-599.
49. Ridenour, G.M. and E.H. Armbruster. 1949. "Bactericidal Effects of Chlorine Dioxide." *J. AWWA*. 41:537.
50. Ridenour, G. M. and R.S. Ingols. 1947. "Bactericidal Properties of Chlorine Dioxide." *J. AWWA*. 39.
51. Ridenour, G.M., and R.S. Ingols. 1946. "Inactivation of Poliomyelitis Virus by Free Chlorine." *Amer. Public Health*. 36:639.
52. Ridenour, G.M., and R.S. Ingols, and E.H. Armbruster. 1949. "Sporicidal Properties of Chlorine Dioxide." *Water & Sewage Works*. 96(8):279.
53. Roberts, P.V., E.M. Aieta, J.D. Berg, and B.M. Chow. 1980. "Chlorine Dioxide for Wastewater Disinfection: A Feasibility Evaluation." Stanford University Technical Report 251. October.

- 
54. Roller, S. D. et al. 1980. "Mode of Bacterial Inactivation by Chlorine Dioxide." *Water Res.* 14:635.
  55. Singer, P.C. 1992. "Formation and Characterization of Disinfection Byproducts." Presented at the First International Conference on the Safety of Water Disinfection: Balancing Chemical and Microbial Risks.
  56. Singer, P.C., and W.K. O'Neil. 1987. "Technical Note: The Formation of Chlorate from the Reaction of Chlorine and Chlorite in Dilute Aqueous Solution." *J. AWWA.* 79(11):75.
  57. Smith, J. E., and J.L. McVey. 1973. "Virus Inactivation by Chlorine Dioxide and Its Application to Storm Water Overflow." Proceeding, ACS annual meeting. 13(2):177.
  58. Sobsey, M. 1988. "Detection and Chlorine Disinfection of Hepatitis A in Water." CR-813-024, EPA Quarterly Report, December.
  59. Sproul, O. J. et al. 1983. "Comparison of Chlorine and Chlorine Dioxide for Inactivation of Amoebic Cyst." *Envir. Technol. Letters.* 4:335.
  60. Thompson, A.L. 1989. "Practical Considerations for Application of Chlorine Dioxide in Municipal Water Systems." Conference proceedings,, Chlorine Dioxide Workshop. AWWARF, CMA, EPA. Denver, CO.
  61. Trakhtman, N.N. 1949. "Chlorine Dioxide in Water Disinfection." *Chemical Abstracts.* 43:1508.
  62. USEPA (U.S. Environmental Protection Agency). 1983. "Trihalomethanes in Drinking Water: Sampling, Analysis, Monitoring, and Compliance." EPA 570/9-83-002, August.
  63. USEPA. 1979. "Effect of Particulates on Disinfection of Enteroviruses and Coliform Bacteria in Water by Chlorine Dioxide." EPA-600/2-79-054.
  64. USEPA 1978. "Effect of Particulates on Inactivation of Enteroviruses in Water by Chlorine Dioxide." EPA-600/9-79-018, Cincinnati, OH.
  65. Werdehoff, K.S, and P.C. Singer. 1987. "Chlorine Dioxide Effects on THMFP, TOXFP and the Formation of Inorganic By-Products." *J. AWWA.* 79(9):107.

THIS PAGE INTENTIONALLY LEFT BLANK

<b>4.</b>	<b>CHLORINE DIOXIDE .....</b>	<b>4-1</b>
4.1	CHLORINE DIOXIDE CHEMISTRY .....	4-1
4.1.1	Oxidation Potential.....	4-1
4.2	GENERATION.....	4-2
4.2.1	Introduction.....	4-2
4.2.2	Chlorine Dioxide Purity.....	4-3
4.2.3	Methods of Generating Chlorine Dioxide.....	4-4
4.1.4	Generator Design .....	4-9
4.1.5	Chemical Feed Systems.....	4-11
4.1.6	Generator Power Requirements.....	4-13
4.3	PRIMARY USES AND POINTS OF APPLICATION FOR CHLORINE DIOXIDE.....	4-13
4.3.1	Disinfection.....	4-13
4.3.2	Taste and Odor Control .....	4-14
4.3.3	Oxidation of Iron and Manganese .....	4-14
4.4	PATHOGEN INACTIVATION AND DISINFECTION EFFICACY.....	4-15
4.4.1	Inactivation Mechanisms .....	4-15
4.4.2	Environmental Effects .....	4-15
4.4.3	Disinfection Efficacy .....	4-17
4.5	CHLORINE DIOXIDE DISINFECTION BYPRODUCTS.....	4-22
4.5.1	Production of Chlorite and Chlorate.....	4-22
4.5.2	Organic DBPs Produced by Chlorine Dioxide.....	4-25
4.5.3	Chlorine Dioxide DBP Control Strategies .....	4-25
4.6	STATUS OF ANALYTICAL METHODS.....	4-26
4.6.1	Chlorine Dioxide and Chlorite Analytical Methods .....	4-27
4.6.2	Chlorine Dioxide Monitoring for Systems Using Chlorine Dioxide .....	4-27
4.6.3	Chlorite Monitoring for Systems Using Chlorine Dioxide .....	4-28
4.7	OPERATIONAL CONSIDERATIONS.....	4-28
4.7.1	Process Considerations .....	4-30
4.7.2	Generator Operation.....	4-31
4.7.3	Feed Chemicals .....	4-31
4.8	SUMMARY .....	4-33
4.8.1	Advantages and Disadvantages of Chlorine Dioxide Use.....	4-33
4.8.2	Summary Table .....	4-34
4.9	REFERENCES .....	4-35

Table 4-1.	Commercial Chlorine Dioxide Generators.....	4-5
Table 4-2.	Surface Water Chlorine Dioxide Demand Study Results.....	4-14
Table 4-3.	Analytical Methods for Chlorine Dioxide and Related Compounds.....	4-30
Table 4-4.	Properties of Sodium Chlorite as Commercially Available.....	4-32
Table 4-5.	Summary for Chlorine Dioxide .....	4-34

Figure 4-1.	Conventional Chlorine Dioxide Generator When Using Chlorine-Chlorite Method.....	4-7
Figure 4-2.	Chlorine Dioxide Generation Using Recycled Aqueous Chlorine Method.....	4-8
Figure 4-3.	Effect of Temperature on <i>N. Gruberi</i> Cyst Inactivation at pH 7 .....	4-17
Figure 4-4.	Comparison of Germicidal Efficiency of Chlorine Dioxide and Chlorine.....	4-19
Figure 4-5.	CT Values for Inactivation of <i>Giardia</i> Cysts by Chlorine Dioxide.....	4-21
Figure 4-6.	CT Values for Inactivation of Viruses by Chlorine Dioxide.....	4-22
Figure 4-7.	<i>C. parvum</i> Inactivation by Chlorine Dioxide at 20°C.....	4-23
Figure 4-8.	<i>C. parvum</i> Inactivation by Chlorine Dioxide at 10°C.....	4-23

# 5. POTASSIUM PERMANGANATE

---

Potassium permanganate (KMnO<sub>4</sub>) is used primarily to control taste and odors, remove color, control biological growth in treatment plants, and remove iron and manganese. In a secondary role, potassium permanganate may be useful in controlling the formation of THMs and other DBPs by oxidizing precursors and reducing the demand for other disinfectants (Hazen and Sawyer, 1992). The mechanism of reduced DBPs may be as simple as moving the point of chlorine application further downstream in the treatment train using potassium permanganate to control taste and odors, color, algae, etc. instead of chlorine. Although potassium permanganate has many potential uses as an oxidant, it is a poor disinfectant.

## 5.1 Potassium Permanganate Chemistry

### 5.1.1 Oxidation Potential

Potassium permanganate is highly reactive under conditions found in the water industry. It will oxidize a wide variety of inorganic and organic substances. Potassium permanganate (Mn 7+) is reduced to manganese dioxide (MnO<sub>2</sub>) (Mn 4+) which precipitates out of solution (Hazen and Sawyer, 1992). All reactions are exothermic. Under acidic conditions the oxidation half-reactions are (CRC, 1990):



Under alkaline conditions, the half-reaction is (CRC, 1990):



Reaction rates for the oxidation of constituents found in natural waters are relatively fast and depend on temperature, pH, and dosage.

### 5.1.2 Ability To Form a Residual

It is not desirable to maintain a residual of KMnO<sub>4</sub> because of its tendency to give water a pink color.

## 5.2 Generation

Potassium permanganate is only supplied in dry form. A concentrated KMnO<sub>4</sub> solution (typically 1 to 4 percent) is generated on-site for water treatment applications; the solution is pink or purple in color. KMnO<sub>4</sub> has a bulk density of approximately 100 lb/ft<sup>3</sup> and its solubility in water is 6.4 g/mL at 20°C.

Depending on the amount of permanganate required, these solutions can be made up in batch modes, using dissolver/storage tanks with mixers and a metering pump for small feed systems. Larger systems will include a dry chemical feeder, storage hopper and dust collector configured to automatically supply permanganate to the solution dissolver/storage tank.

KMnO<sub>4</sub> solution is made up of dry crystalline permanganate solids added to make-up water and then stirred to obtain the desired permanganate concentration. The cost of KMnO<sub>4</sub> ranges from \$1.50 to \$2.00 per pound (1997 costs), depending on the quantity ordered. Shipment containers are typically buckets or drums. Potassium permanganate is supplied in various grades. Pure KMnO<sub>4</sub> is non-hygroscopic but technical grades will absorb some moisture and will have a tendency to cake together. For systems using dry chemical feeders, a free-flowing grade is available that contains anti-caking additives (Hazen and Sawyer, 1992).

Potassium permanganate is a strong oxidizer and should be carefully handled when preparing the feed solution. No byproducts are generated from making the solution. However, this dark purple/black crystalline solid can cause serious eye injury, is a skin and inhalation irritant, and can be fatal if swallowed. As such, special handling procedures include the use of safety goggles and a face shield, an MSA™/NIOSH approved dust mask, and wearing impervious gloves, coveralls, and boots to minimize skin contact.

## 5.3 Primary Uses and Points of Application

Although potassium permanganate can inactivate various bacteria and viruses, it is not used as a primary or secondary disinfectant when applied at commonly used treatment levels. Potassium permanganate levels that may be required to obtain primary or secondary disinfection could be cost prohibitive. However, potassium permanganate is used in drinking water treatment to achieve a variety of other purposes including:

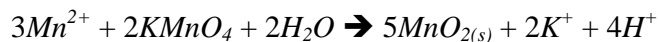
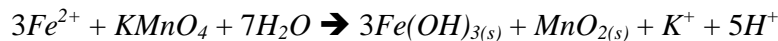
- Oxidation of iron and manganese;
- Oxidation of taste and odor compound;
- Control of nuisance organisms; and
- Control of DBP formation.

### 5.3.1 Primary Uses

#### 5.3.1.1 *Iron and Manganese Oxidation*

A primary use of permanganate is iron and manganese removal. Permanganate will oxidize iron and manganese to convert ferrous (2+) iron into the ferric (3+) state and 2+ manganese to the 4+ state. The oxidized forms will precipitate as ferric hydroxide and manganese hydroxide (AWWA, 1991). The precise chemical composition of the precipitate will depend on the nature of the water, temperature, and pH.

The classic reactions for the oxidation of iron and manganese are:



These reactions show that alkalinity is consumed through acid production at the rate of 1.49 mg/L as CaCO<sub>3</sub> per mg/L of Fe<sup>+2</sup> and 1.21 mg/L as CaCO<sub>3</sub> per mg/L of Mn<sup>+2</sup> oxidized. This consumption of alkalinity should be considered when permanganate treatment is used along with alum coagulation, which also requires alkalinity to form precipitates.

The potassium permanganate dose required for oxidation is 0.94 mg/mg iron and 1.92 mg/mg manganese (Culp/Wesner/Culp, 1986). In practice, the actual amount of potassium permanganate used has been found to be less than that indicated by stoichiometry. It is thought that this is because of the catalytic influence of MnO<sub>2</sub> on the reactions (O'Connell, 1978). The oxidation time ranges from 5 to 10 minutes, provided that the pH is over 7.0 (Kawamura, 1991).

### **5.3.1.2 Oxidation of Taste and Odor Compounds**

Potassium permanganate is used to remove taste and odor causing compounds. Lalezary et al. (1986) used permanganate to treat earthy-musty smelling compounds in drinking water. Doses of potassium permanganate used to treat taste and odor causing compounds range from 0.25 to 20 mg/L.

### **5.3.1.3 Control of Nuisance Organisms**

#### **Asiatic Clams**

Cameron et al. (1989) investigated the effectiveness of potassium permanganate to control the Asiatic clam in both the juvenile and adult phases. The adult Asiatic clam was found to be much more resistant to permanganate than the juvenile form. Potassium permanganate doses used to control the juvenile Asiatic clam range from 1.1 to 4.8 mg/L.

#### **Zebra Mussels**

Klerks and Fraleigh (1991) evaluated the effectiveness of permanganate against adult zebra mussels. Continuous potassium permanganate dosing of 0.5 to 2.5 mg/L proved to be the most effective.

### **5.3.1.4 DBP Control**

It is anticipated that potassium permanganate may play a role in disinfection and DBP control strategies in water treatment. Potassium permanganate could be used to oxidize organic precursors at the head of the treatment plant minimizing the formation of byproducts at the downstream disinfection stage of the plant (Hazen and Sawyer, 1992). Test results from a study conducted at two water treatment plants in North Carolina (Section 5.5.1) showed that pretreatment with permanganate reduced chloroform formation; however, the reduction was small at doses typically used at water

treatment plants. The study also indicated that pre-oxidation with permanganate had no net effect on the chlorine demand of the water (Singer et al., 1980).

### 5.3.2 Points of Application

In conventional treatment plants, potassium permanganate solution is added to the raw water intake, at the rapid mix tank in conjunction with coagulants, or at clarifiers upstream of filters. In direct filtration plants, this oxidant is typically added at the raw water intake to increase the contact time upstream of the filter units (Montgomery, 1985). In all cases, potassium permanganate is added prior to filtration.

Potassium permanganate solution is typically pumped from the concentrated solution tank to the injection point. If the injection point is a pipeline, a standard injection nozzle protruding midway into the pipe section is used. Injection nozzles can also be used to supply the solution to mixing chambers and clarifiers. Permanganate is a reactive, fast-acting oxidizer and does not require special mixing equipment at the point of injection to be effective.

#### 5.3.2.1 Impact on Other Treatment Processes

The use of potassium permanganate has little impact on other treatment processes at the water treatment facility. See Section 5.7 for permanganate operational considerations.

## 5.4 Pathogen Inactivation and Disinfection Efficacy

Potassium permanganate is an oxidizing agent widely used throughout the water industry. While it is not considered a primary disinfectant, potassium permanganate has an effect on the development of a disinfection strategy by serving as an alternative to pre-chlorination or other oxidants at locations in a treatment plant where chemical oxidation is desired for control of color, taste and odor, and algae.

### 5.4.1 Inactivation Mechanisms

The primary mode of pathogen inactivation by potassium permanganate is direct oxidation of cell material or specific enzyme destruction (Webber and Posselt, 1972). In the same fashion, the permanganate ion ( $MnO_4^-$ ) attacks a wide range of microorganisms such as bacteria, fungi, viruses, and algae.

Application of potassium permanganate results in the precipitation of manganese dioxide. This mechanism represents an additional method for the removal of microorganisms from potable water (Cleasby et al., 1964). In colloidal form, the manganese dioxide precipitant has an outer layer of exposed OH groups. These groups are capable of adsorbing charged species and particles in addition to neutral molecules (Posselt et al., 1967). As the precipitant is formed, microorganisms can be adsorbed into the colloids and settled.

## 5.4.2 Environmental Effects

Inactivation efficiency depends upon the permanganate concentration, contact time, temperature, pH, and presence of other oxidizable material. Several of the key parameters are discussed below.

### 5.4.2.1 pH

Alkaline conditions enhance the capability of potassium permanganate to oxidize organic matter; however, the opposite is true for its disinfecting power. Typically, potassium permanganate is a better biocide under acidic conditions than under alkaline conditions (Cleasby et al., 1964 and Wagner, 1951). Results from a study conducted in 1964 indicated that permanganate generally was a more effective biocide for *E. coli* at lower pHs, exhibiting more than a 2-log removal at a pH of 5.9 and a water temperature of both 0 and 20°C (Cleasby et al., 1964). In fact, Cleasby found that pH is the major factor affecting disinfection effectiveness with potassium permanganate. As such, natural waters with pH values of 5.9 or less would be conducive to potassium permanganate disinfection, particularly as a substitute for prechlorination. Moreover a study conducted at the University of Arizona found that potassium permanganate will inactivate *Legionella pneumophila* more rapidly at pH 6.0 than at pH 8.0 (Yahya et al., 1990a).

These results are consistent with earlier results concerning the effects of pH on commercial antiseptic performance (Hazen and Sawyer, 1992). In general, based on the limited results from these studies, disinfection effectiveness of potassium permanganate increases with decreasing pH.

### 5.4.2.2 Temperature

Higher temperatures slightly enhance bactericidal action of potassium permanganate. The results from a study conducted on polio virus showed that oxidation deactivation is enhanced by higher temperatures (Lund, 1963). These results are consistent with results obtained for *E. coli* inactivation (Cleasby et al., 1964).

### 5.4.2.3 Dissolved Organics and Inorganics

The presence of oxidizable organics or inorganics in the water reduces the disinfection effectiveness of this disinfectant because some of the applied potassium permanganate will be consumed in the oxidation of organics and inorganics. Permanganate oxidizes a wide variety of inorganic and organic substances in the pH range of 4 to 9. Under typical water conditions, iron and manganese are oxidized and precipitated and most contaminants that cause odors and tastes, such as phenols and algae, are readily degraded by permanganate (Hazen and Sawyer, 1992).

## 5.4.3 Use as a Disinfectant

A number of investigations have been performed to determine the relative capability of potassium permanganate as a disinfectant. The following sections contain a description of the disinfection efficiency of potassium permanganate in regards to bacteria, virus, and protozoa inactivation.

#### **5.4.3.1 Bacteria Inactivation**

High dosage rates were required to accomplish complete inactivation of bacteria in three studies. Early research showed that a dose of 2.5 mg/L was required for complete inactivation of coliform bacteria (Le Strat, 1944). In this study, water from the Marne River was dosed with potassium permanganate at concentrations of 0 to 2.5 mg/L. Following mixing, the samples were placed in a darkened room for 2 hours at a constant temperature of 19.8°C.

Banerjea (1950) investigated the disinfectant ability of potassium permanganate on several waterborne pathogenic microorganisms. The investigation studied *Vibrio cholerae*, *Salm. typhi*, and *Bact. flexner*. The results indicated that doses of 20 mg/L and contact times of 24 hours were necessary to deactivate these pathogens; however, even under these conditions the complete absence of *Salm. typhi* or *Bact. flexner* was not assured, even at a potassium permanganate concentration that turned the water an objectionable pink color.

Results from a study conducted in 1976 at the Las Vegas Valley Water District/Southern Nevada System of Lake Mead water showed that complete removal of coliform bacteria were accomplished at doses of 1, 2, 3, 4, 5, and 6 mg/L (Hazen and Sawyer, 1992). Contact times of 30 minutes were provided with doses of 1 and 2 mg/L, and 10 minutes contact times were provided for higher dosages in this study.

#### **5.4.3.2 Virus Inactivation**

Potassium permanganate has been proven effective against certain viruses. A dose of 50 mg/L of potassium permanganate and a contact time of 2 hours was required for inactivation of poliovirus (strain MVA) (Hazen and Sawyer, 1992). A “potassium” permanganate dose of 5.0 mg/L and a contact time of 33 minutes was needed for 1-log inactivation of type 1 poliovirus (Yahya et al., 1990b). Tests showed a significantly higher inactivation rate at 23°C than at 7°C; however, there was no significant difference in activation rates at pH 6.0 and pH 8.0.

Potassium permanganate doses from 0.5 to 5 mg/L were capable of obtaining at least a 2 log inactivation of the surrogate virus, MS-2 bacteriophage with *E. coli* as the host bacterium (Yahya et al., 1989). Results showed that at pH 6.0 and 8.0, a 2-log inactivation occurred after a contact time of at least 52 minutes and a residual of 0.5 mg/L. At a residual of 5.0 mg/L, approximately 7 and 13 minutes were required for 2-log inactivation at pHs of 8.0 and 6.0, respectively. These results contradict the previously cited studies that potassium permanganate becomes more effective as the pH decreases.

#### **5.4.3.3 Protozoa Inactivation**

No information pertaining to protozoa inactivation by potassium permanganate is available in the literature. However, based on the other disinfectants discussed in this report, protozoa are significantly more resistant than viruses; therefore, it is likely that the dosages and contact times required for protozoa inactivation would be impractical.

#### 5.4.3.4 CT Curves

Table 5-1 shows CT values for the inactivation of bacteriophage MS-2. These data have been provided as an indication of the potential of potassium permanganate. These values are somewhat inconsistent and do not include a safety factor and should not be used to establish CT requirements.

**Table 5-1. Potassium Permanganate CT Values for 2-log Inactivation of MS-2 Bacteriophage**

Residual (mg/L)	pH 6.0 <sup>1</sup> (mg min / L)	pH 8.0 <sup>1</sup> (mg min / L)
0.5	27.4 (a)	26.1 (a)
1.5	32.0 (a)	50.9 (b)
2	-	53.5 (c)
5	63.8 (a)	35.5 (c)

Source: USEPA, 1990.

Note: <sup>1</sup> Letters indicate different experimental conditions.

A 1990 study investigated CT values for *Legionella pneumophila* inactivation. CT values for 99 percent (2-log) inactivation of *Legionella pneumophila* at pH 6.0 were determined to be 42.7 mg min/L at a dose of 1.0 mg/L (contact time 42.7 minutes) and 41.0 mg min/L at a dose of 5.0 mg/L (contact time 8.2 minutes) (Yahya et al., 1990a).

## 5.5 Disinfection Byproduct Formation

No literature is available that specifically addressed DBPs when using potassium permanganate. However, several studies have been conducted with water treatment plants that have replaced the pre-chlorination process with potassium permanganate and relocated the point of chlorine addition for post-treatment disinfection. Pretreatment with permanganate in combination with post-treatment chlorination will typically result in lower DBP concentrations than would otherwise occur from traditional pre-chlorination (Ficek and Boll, 1980; and Singer et al., 1980). Under this approach, potassium permanganate serves as a substitute for chlorine to achieve oxidation and may also reduce the concentration of natural organic matter (NOM). However, systems should evaluate the impact on CT values before moving the point of chlorination. The following subsections summarize the outcomes of two studies.

### 5.5.1 Chapel-Hill and Durham, North Carolina Water Treatment Plants

An investigation was conducted at the Chapel-Hill and Durham Water Treatment Plants to evaluate the effects of potassium permanganate pretreatment on trihalomethane formation (Singer et al., 1980). The Chapel-Hill Water Treatment Plant uses pre-chlorination prior to the rapid mix tank. At the Durham Water Treatment Plant, chlorine is not added until after the sedimentation basin prior to the filtration. Both are surface water treatment plants, treating water with low concentrations of

alkalinity. Both sources of water are known to have high trihalomethane formation potentials (Young and Singer, 1979).

Raw water samples taken from Chapel-Hill were found to contain relatively high turbidities, ranging from 46 to 110 NTU and total organic carbon (TOC) concentrations ranging from 5.6 to 8.9 mg/L. The Durham samples were coagulated then allowed to settle, which resulted in better water quality than the Chapel-Hill samples. Following settling, this sample had a turbidity of 6.4 NTU and a TOC of 2.9 mg/L. Sulfuric acid and sodium hydroxide were used to adjust the sample pH to either 6.5 or 10.3. These pH values were selected because they encompass the pH range typically found in surface water coagulation-filtration and lime-softening treatment plants.

Potassium permanganate doses of 2 and 5 mg/L were found to be totally consumed within 1 and 4 hours, respectively, by the Chapel-Hill samples. At doses of 2 and 5 mg/L, the potassium permanganate demand of the Durham samples after 4 hours were approximately 1.3 and 1.8 mg/L, respectively.

This difference in permanganate demands between the Chapel-Hill and Durham samples may be attributed to the water quality of the samples, in particular the TOC concentrations. TOC measurements before and after the application of permanganate were approximately equal; however, it is likely that the TOC after disinfection was at a higher oxidation state. Results of this study also showed that permanganate is more reactive as an oxidant at higher pH values.

Despite the high degree of permanganate consumption, the reaction of permanganate appears to have relatively little effect on chlorine demands. For example, consumption of 6 mg/L of permanganate resulted in a chlorine demand reduction of approximately 1 mg/L. This observation suggests that permanganate reacts with water impurities in a different manner, or at different sites, than chlorine. One other possible explanation is that permanganate oxidizes certain organic substances, thereby eliminating their chlorine demand and only partially oxidizing other organic substances making them more reactive to chlorine.

Both the Chapel-Hill and Durham samples were tested for their chloroform formation potential. This measurement is based on the amount of chloroform produced after seven days. The potential of the Durham sample was reduced by 30 and 40 percent at pH 6.5 and 10.3, respectively, as a result of the application of 10 mg/L of potassium permanganate for a period of 2 hours. Similar results were obtained for the Chapel-Hill samples; however, the results at pH 6.5 did not show a reduction in chloroform formation potential at low doses.

Two experiments were conducted on Chapel-Hill raw water to further explore the effects of low doses of permanganate. The results indicated that permanganate has no effect on chloroform production at doses up to 1 mg/L. At higher doses, chloroform formation potentials were reduced.

In summary, the key results obtained from the studies conducted at the Chapel-Hill and Durham Water treatment plants were:

- The reactivity of permanganate is a function of pH, permanganate dose, and raw water quality.
- Permanganate reduces chloroform formation potentials. The reduction in the chloroform formation potential is proportional to the amount of permanganate available after the initial demand is overcome. Doses up to 1 mg/L were found to have no effect on chloroform formation potentials.
- At pretreatment doses typically employed at water treatment plants, the effect of permanganate on the overall chloroform production is relatively small. If permanganate is to be used specifically to reduce trihalomethane formation, larger doses will be required. However, one advantage for using permanganate for pretreatment is that the point of application of chlorine can be shifted downstream of the sedimentation basins. This is likely to result in fewer trihalomethane compounds.

### 5.5.2 American Water Works Association Research Foundation TTHM Study

Another investigation examined the impacts of potassium permanganate addition on byproduct formation at four water treatment plants (Ficek and Boll, 1980). All were conventional plants using pre-chlorination in the treatment process. Plant design capacities ranged from 4.5 to 15 mgd. Process modifications were made at each plant to replace the pre-chlorination facilities with oxidation facilities for potassium permanganate addition. After the modifications were complete, an AWWARF research team conducted a study to determine the impact of potassium permanganate addition on total trihalomethane (TTHM) concentrations (George et al., 1990).

Prior to switching from pre-chlorination to pre-oxidation with potassium permanganate, average daily TTHM concentrations at all four plants were between 79 and 99  $\mu\text{g/L}$ . The average TTHM concentration for all four plants was 92  $\mu\text{g/L}$ . Following the conversion to potassium permanganate, three of the four plants experienced greater than 30 percent reduction in TTHM concentrations. In addition to TTHM reduction, potassium permanganate was found to oxidize taste and odor causing compounds, iron and manganese, organic and inorganic matter, and reduce algal growth. Results from the study also showed that the simultaneous application of potassium permanganate and chlorine can increase THM formation.

## 5.6 Status of Analytical Methods

The atomic adsorption spectrophotometry method for the measurement of manganese is the preferred method for measuring permanganate concentrations. Two colorimetric methods, persulfate and periodate are also available (Standard Methods, 1995).

## 5.7 Operational Considerations

In utilizing potassium permanganate in water treatment, caution should be taken to prevent overdosing, in which case, excess manganese will pass through the treatment plant. Proper dosing

should be maintained to ensure that all of the permanganate is reduced (i.e., forming  $MnO_2$  solids) and removed from the plant upstream of, or within, the filters. If residual manganese is reduced downstream of the filters, the resulting solids can turn the finished water a brown/black color and precipitate in the homes of consumers on heat exchange surfaces such as hot water heaters and dishwashers.

Use of potassium permanganate can also be a source of manganese in the finished water, which is regulated in drinking water with a secondary maximum contaminant level of 0.05 mg/L. Under reducing conditions, the  $MnO_2$  solids accumulated in filter backwash water and settling basins can be reduced to soluble  $Mn^{2+}$  and pass through the filters thereby remaining in the finished water.

Also, under these conditions, soluble  $Mn^{2+}$  in return water from settling basin dewatering facilities and filter backwash water recycled to the head of the plant are potential sources of manganese that will have to be treated and/or controlled to minimize finished water manganese levels (Singer, 1991).

Overdosing of permanganate in conventional plants is generally corrected by settling the excess  $MnO_2$  solids in the settling basin. Removal of the excess permanganate can be monitored qualitatively by observing the disappearance of the pink color characteristic of permanganate. In plants that do not utilize flocculation and sedimentation processes permanganate dosing should be closely monitored (Montgomery, 1985).

In general, potassium permanganate does not interfere with other treatment processes or plant conditions. Permanganate can be added downstream of, or concurrently with, coagulant and filter polymer aids. Powdered activated carbon (PAC) and permanganate should not be added concurrently. PAC should be added downstream of permanganate because it may consume permanganate, rendering it unavailable for the oxidation of target organics. (Montgomery, 1985).

The space requirements for permanganate feed equipment vary depending on the type and size of feed system. Dry feed systems require about half the floor area of batch systems because batch systems typically have two dissolving tanks for redundancy. However, the head space requirements are greater for dry feed systems where the storage hopper and dust collector are stacked on top of the dry feeder (Kawamura, 1991). On-site storage of potassium permanganate also warrants some consideration. Per OSHA requirements, oxidants such as permanganate should be stored separate from organic chemicals such as polymers and activated carbon.

## 5.8 Summary

### 5.8.1 Advantages and Disadvantages of Potassium Permanganate Use

The following list highlights selected advantages and disadvantages of using potassium permanganate as a disinfection method for drinking water. Because of the wide variation of system

size, water quality, and dosages applied, some of these advantages and disadvantages may not apply to a particular system.

### **Advantages**

- Potassium permanganate oxidizes iron and manganese.
- Potassium permanganate oxidizes odor and taste-causing compounds.
- Potassium permanganate is easy to transport, store, and apply.
- Potassium permanganate is useful in controlling the formation of THMs and other DBPs.
- Potassium permanganate controls nuisance organisms.
- The use of potassium permanganate has little impact on other treatment processes at the water treatment facility.
- Potassium permanganate has been proven effective against certain viruses.

### **Disadvantages**

- Long contact time is required.
- Potassium permanganate has a tendency to give water a pink color.
- Potassium permanganate is toxic and irritating to skin and mucous membranes.
- No byproducts are generated when preparing the feed solution, however this dark purple/black crystalline solid can cause serious eye injury, is a skin and inhalation irritant, and can be fatal if swallowed. Over-dosing is dangerous and may cause health problems such as chemical jaundice and drop in blood pressure.

## **5.8.2 Summary Table**

More research is needed regarding the disinfection properties and oxidation byproducts of permanganate in water treatment. Also, a CT credit needs to be assigned to permanganate if it is to be utilized as a disinfectant. However, given that alternative oxidants, such as ozone and chlorine dioxide, demonstrate much greater efficacy in microbial control, permanganate is not likely to be utilized as a primary oxidant for precursor control. Table 5-2 summarizes the information presented in this chapter regarding the use of potassium permanganate in the drinking water treatment process.

**Table 5-2. Summary of Potassium Permanganate Use**

Consideration	Description
Generation	Product supplied in dry form in buckets, drums, and bulk. On-site generation of solution is required using chemical mixing and feed equipment.
Primary uses	Control of odor and taste, remove color, control biological growth, and remove iron and manganese.
Inactivation efficiency	Not a good disinfectant. Can serve better as an alternative to chlorine or other disinfectants where chemical oxidation is desired.
Byproduct formation	No literature was found that specifically addressed DBP formation from potassium permanganate oxidation. Pretreatment with permanganate in combination with post-treatment chlorination will typically result in lower DBP concentrations than would otherwise occur from traditional pre-chlorination.
Limitations	Not a good disinfectant; primarily used for pretreatment to minimize chlorine usage and byproduct formation.
Points of application	Conventional Treatment: raw water addition, rapid mix tank in conjunction with coagulants, clarifiers upstream of filters. Direct Filtration: raw water intake. In all cases permanganate should be added upstream of filters.
Special considerations	Caution should be taken to prevent overdosing. More research is needed to determine disinfection properties and oxidation byproducts.

## 5.9 References

1. AWWA (American Water Works Association). 1991. *Guidance Manual for Compliance with the Filtration and Disinfection Requirements for Public Water Systems Using Surface Water Sources*.
2. Banerjea, R. 1950. "The Use of Potassium Permanganate in the Disinfection of Water." *Ind. Med. Gaz.* 85:214-219.
3. Cameron, G.N., J.M. Symons, S.R. Spencer, and J.Y. Ma. 1989. "Minimizing THM Formation During Control of the Asiatic Clam: A Comparison of Biocides." *J. AWWA.* 81(10):53-62.
4. Cleasby, J.L., E.R. Baumann, and C.D. Black. 1964. "Effectiveness of Potassium Permanganate for Disinfection." *J. AWWA.* 56:466-474.
5. CRC. 1990. *Handbook of Chemistry and Physics*, seventy-first edition. D.L. Lide (editor). CRC Press, Boca Raton, FL.
6. Culp/Wesner/Culp. 1986. *Handbook of Public Water Systems*. Van Nostrand Reinhold, New York, NY.

7. Ficek, K.J., and J.E. Boll. 1980. "Potassium Permanganate: An Alternative to Prechlorination." *Aque.* 7:153-156.
8. George, D.B., V.D. Adams, S.A. Huddleston, K.L. Roberts, and M.B. Borup. 1990. *Case Studies of Modified Disinfection Practices for Trihalomethane Control, Potassium Permanganate.* AWWAR and AWWA, Denver, CO.
9. Hazen and Sawyer. 1992. *Disinfection Alternatives for Safe Drinking Water.* Van Nostrand Reinhold, New York, NY.
10. Kawamura, S. 1991. *Integrated Design of Water Treatment Facilities.* John Wiley & Sons, Inc., New York, NY.
11. Klerks, P.L. and P.C. Fraleigh. 1991. "Controlling Adult Zebra Mussels with Oxidants." *J.AWWA.* 83(12):92-100.
12. Lalezary, S., M. Pirbazari, and M.J. McGuire. 1986. "Oxidation of Five Earthy-Musty Taste and Odor Compounds." *J. AWWA.* 78(3):62.
13. Le Strat. 1944. "Comparison des pouvoirs sterilisants du permanganate de potasses et de l'eau de javel a l'egard d'eaux contaminees." *Ann. Hygiene.*
14. Lund, E. 1963. "Significance of Oxidation in Chemical Interaction of Polioviruses." *Arch. Ges. Virusforsch.* 12(5):648-660.
15. Montgomery, J.M. 1985. *Water Treatment Principles and Design.* John Wiley & Sons, Inc., New York, NY.
16. O'Connell, R.T. 1978. "Suspended Solids Removal." *Water Treatment Plant Design.* R.L. Sanks (editor). Ann Arbor Science Publishers, Inc, Ann Arbor, MI.
17. Posselt, H.S., F. J. Anderson, and W.J. Webber. 1967. "The Surface Chemistry of Hydrous Manganese Dioxide." Presented at meeting of Water, Air, and Waste Chemistry Division, American Chemical Society, Bar Harbor, FL, April.
18. Singer, P.C. 1991. "Research Needs for Alternative Oxidants and Disinfectants." Presented at the Annual AWWA Conference, Philadelphia, June 23-27.
19. Singer, P.C., J.H. Borchardt, and J.M. Colthurst. 1980. "The Effects of Permanganate Pretreatment on Trihalomethane Formation in Drinking Water." *J. AWWA.* 72(10):573-578.
20. Standard Methods. 1995. *Standard Methods for the Examination of Water and Wastewater,* nineteenth edition. American Public Health Association, AWWA, and Water Pollution Control Fed., Washington, D.C.

21. USEPA. 1990. *Guidance Manual for Compliance with the Filtration and Disinfection Requirements for Public Works Systems Using Surface Water Sources*. Prepared by Malcolm Pirnie, Inc. and HDR Engineering for USEPA. Contract No. 68-01-6989.
22. Wagner, R.R. 1951. "Studies on the Inactivation of Influenza Virus." *Yale J. Biol. Med.* pp. 288-298.
23. Webber, W.J., Jr., and H.S. Posselt. 1972. "Disinfection." *Physicochemical Processes in Water Quality Control*. W. J. Webber (editor). John Wiley & Sons, New York, NY.
24. Yahya, M.T., T.M. Straub, and C.P. Gerba. 1990a. *Inactivation of poliovirus type 1 by Potassium Permanganate*. University of Arizona Preliminary Research Report, Tucson, AZ.
25. Yahya, M.T., Landeen, L.K., and Gerba, C.P. 1990b. Inactivation of *Legionella pneumophila* by Potassium Permanganate. *Environ. Technol.* 11:657-662.
26. Yahya, M.T., et al. 1989. "Evaluation of Potassium Permanganate for the Inactivation of MS-2 in Water Systems." *J. Environ. Sci. Health.* A34(8):979-989.
27. Young, J.S. and P.C. Singer. 1979. "Chloroform Formation in Public Water Supplies: A Case Study." *J. AWWA.* 71(2):87.

**5. POTASSIUM PERMANGANATE ..... 5-1**

5.1 POTASSIUM PERMANGANATE CHEMISTRY ..... 5-1

5.1.1 Oxidation Potential..... 5-1

5.1.2 Ability To Form a Residual ..... 5-1

5.2 GENERATION..... 5-1

5.3 PRIMARY USES AND POINTS OF APPLICATION ..... 5-2

5.3.1 Primary Uses..... 5-2

5.3.2 Points of Application ..... 5-4

5.4 PATHOGEN INACTIVATION AND DISINFECTION EFFICACY ..... 5-4

5.4.1 Inactivation Mechanisms ..... 5-4

5.4.2 Environmental Effects ..... 5-5

5.4.3 Use as a Disinfectant ..... 5-5

5.5 DISINFECTION BYPRODUCT FORMATION..... 5-7

5.5.1 Chapel-Hill and Durham, North Carolina Water Treatment Plants ..... 5-7

5.5.2 American Water Works Association Research Foundation TTHM Study ..... 5-9

5.6 STATUS OF ANALYTICAL METHODS..... 5-9

5.7 OPERATIONAL CONSIDERATIONS..... 5-9

5.8 SUMMARY ..... 5-10

5.8.1 Advantages and Disadvantages of Potassium Permanganate Use ..... 5-10

5.8.2 Summary Table ..... 5-11

5.9 REFERENCES ..... 5-12

Table 5-1. Potassium Permanganate CT Values for 2-log Inactivation of MS-2 Bacteriophage ..... 5-7

Table 5-2. Summary of Potassium Permanganate Use ..... 5-12

## 6. CHLORAMINES

---

The disinfectant potential of chlorine-ammonia compounds or chloramines was identified in the early 1900s. The potential use of chloramines was considered after observing that disinfection by chlorine occurred in two distinct phases. During the initial phase, chlorine reducing compounds (i.e., demand) cause the rapid disappearance of free available chlorine. However, when ammonia was present bactericidal action was observed to continue [even though free chlorine residual was dissipated]. The subsequent disinfection phase occurs by the action of the inorganic chloramines.

### 6.1 Chloramines Chemistry

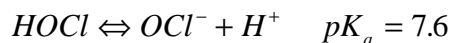
Chloramines are formed by the reaction of ammonia with aqueous chlorine (i.e., HOCl). Initially, chloramines were used for taste and odor control. However, it was soon recognized that chloramines were more stable than free chlorine in the distribution system and consequently were found to be effective for controlling bacterial regrowth. As a result, chloramines were used regularly during the 1930s and 1940s for disinfection. Due to an ammonia shortage during World War II, however, the popularity of chloramination declined. Concern during the past two decades over chlorinated organics (e.g., THM and HAA formation) in water treatment and distribution systems, increased interest in chloramines because they form very few disinfection byproducts (DBPs).

#### 6.1.1 Equilibrium, Kinetic, and Physiochemical Properties

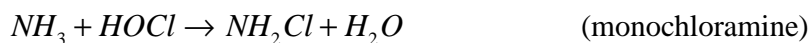
Chloramines are formed from the reaction of chlorine and ammonia. The mixture that results may contain monochloramine (NH<sub>2</sub>Cl), dichloramine (NHCl<sub>2</sub>), or nitrogen trichloride (NCl<sub>3</sub>). When chlorine is dispersed in water, a rapid hydrolysis occurs according to the following reaction:

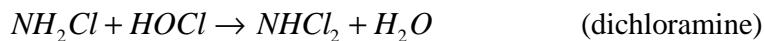


The equilibrium constant ( $K_{eq}$ ) at 25°C is  $3.94 \times 10^4 \text{ M}^{-1}$  for this reaction. In dilute solutions at pH greater than 3, the forward reaction is essentially complete. Hypochlorous acid (HOCl) is a weak acid that dissociates as follows:



Relative proportions of HOCl and OCl<sup>-</sup> are dependent upon pH. Both of the chlorine species in the above reaction are powerful oxidants, capable of reacting with many substances present in water. In aqueous solutions with pH 7.0 to 8.5, HOCl reacts rapidly with ammonia to form inorganic chloramines in a series of competing reactions (White, 1992). The simplified stoichiometry of chlorine-ammonia reactions are as follows:





These competing reactions, and several others, are primarily dependent on pH and controlled to a large extent by the chlorine:ammonia nitrogen ( $\text{Cl}_2:\text{N}$ ) ratio. Temperature and contact time also play a role. Figure 6-1 shows the typical relationships between the chloramine species at various  $\text{Cl}_2:\text{N}$  ratios for pHs ranging from 6.5 to 8.5. This figure shows that monochloramine is predominately formed when the applied  $\text{Cl}_2:\text{N}$  ratio is less than 5:1 by weight. As the applied  $\text{Cl}_2:\text{N}$  ratio increases from 5:1 to 7.6:1, breakpoint reaction occurs, reducing the residual chlorine level to a minimum. Breakpoint chlorination results in the formation of nitrogen gas, nitrate, and nitrogen chloride. At  $\text{Cl}_2:\text{N}$  ratios above 7.6:1, free chlorine and nitrogen trichloride are present. Figure 6-2 shows the relationship between chloramine species as the pH changes (Palin, 1950). The Figure shows that dichloramine becomes a dominant species at low pH.

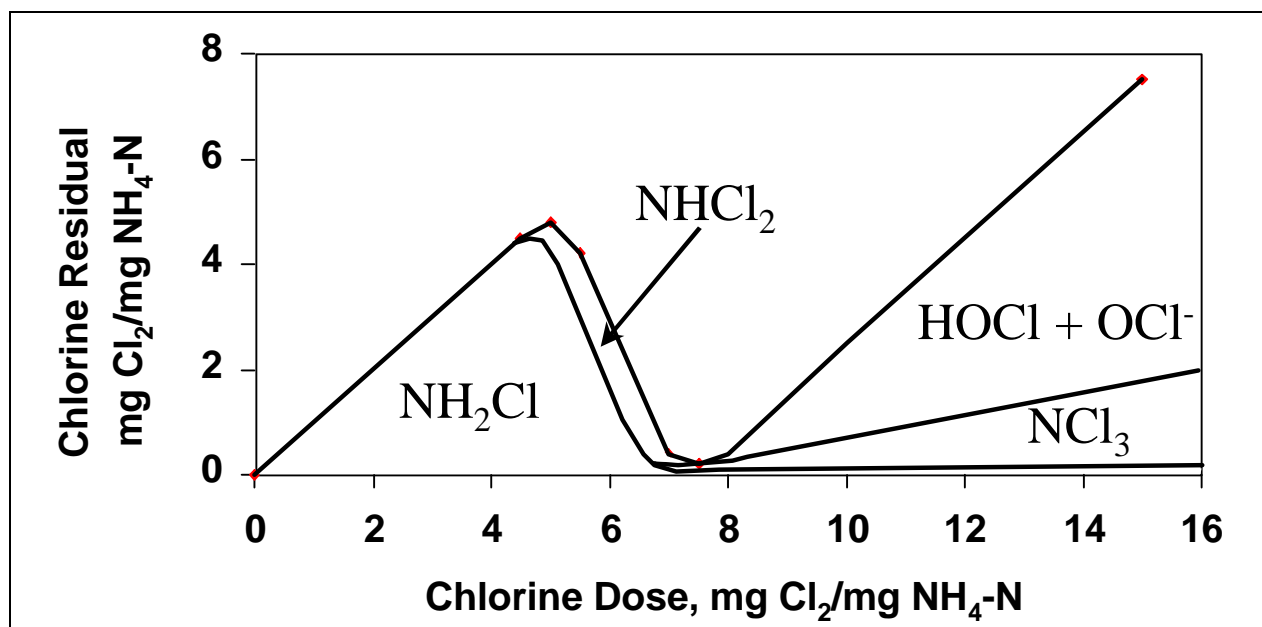
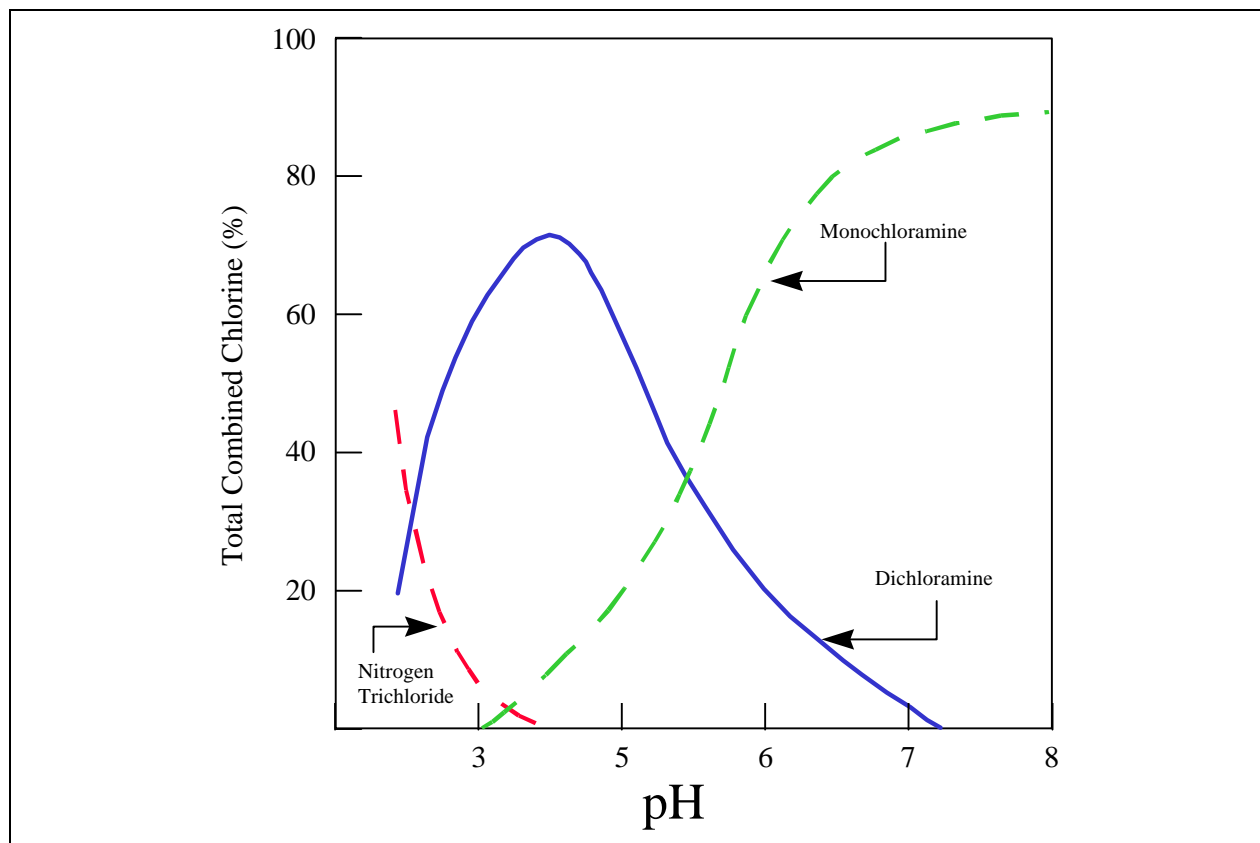


Figure 6-1. Theoretical Breakpoint Curve

To avoid breakpoint reactions, utilities should maintain a  $\text{Cl}_2:\text{N}$  ratio between 3 and 5 by weight. A ratio of 6 is actually optimum for disinfection, but it is difficult to maintain a stable operation at that point in the breakthrough curve. Therefore, a  $\text{Cl}_2:\text{N}$  ratio of 4 is typically accepted as optimal for chloramination.

Furthermore, over a period of a day or so, without any modification of pH or  $\text{Cl}_2:\text{N}$  ratio, monochloramine will degrade slowly to dichloramine to a ratio of 43 percent  $\text{NH}_2\text{Cl}$  to 57 percent  $\text{NHCl}_2$ . Dichloramine is relatively unstable in the presence of  $\text{HOCl}$ ; therefore, pure solutions of this form of monochloramine are difficult to generate and maintain.



Source: Palin, 1950.

**Figure 6-2. Distribution Diagram for Chloramine Species with pH**

## 6.2 Generation

Chloramines are formed by the reaction of hypochlorous acid and ammonia according to the equations described in Section 6.1. Table 6-1 summarizes the theoretical doses of chlorine and ammonia based on these formulas. Monochloramine is the preferred chloramine species for use in disinfecting drinking water because of taste and odor problems associated with dichloramine and nitrogen trichloride. To ensure that these compounds are not formed, common practice was to limit the chlorine to ammonia ratio to 3:1. However, because of problems such as nitrification and biofilm growth, which can be caused by excess ammonia, current practice is to use a  $\text{Cl}_2$ :N ratio in the range of 3:1 to 5:1, with a typical value of 4:1.

**Table 6-1. Chlorine Dose Required for  $\text{NH}_3$  -  $\text{Cl}_2$  Reaction**

Reaction	mg $\text{Cl}_2$ /mg $\text{NH}_3$
Monochloramine ( $\text{NH}_2\text{Cl}$ )	4.2
Dichloramine ( $\text{NHCl}_2$ )	8.4
Nitrogen Trichloride ( $\text{NCl}_3$ )	12.5
Nitrogen ( $\text{N}_2$ )	6.3
Nitrate ( $\text{NO}_3$ )	16.7
Free residual reaction	9

Source: AWWA and ASCE, 1990.

The rate of reaction of monochloramine formation is sensitive to pH. Table 6-2 shows the calculated reaction times for monochloramine formation at 25°C, and at a chlorine:amonia ratio of 3:1 (White, 1992).

**Table 6-2. Time to 99 Percent Conversion of Chlorine to Monochloramine**

pH	Time (seconds)
2	421
4	147
7	0.2
8.3	0.069
12	33.2

## 6.2.1 Chlorine Feed Facilities

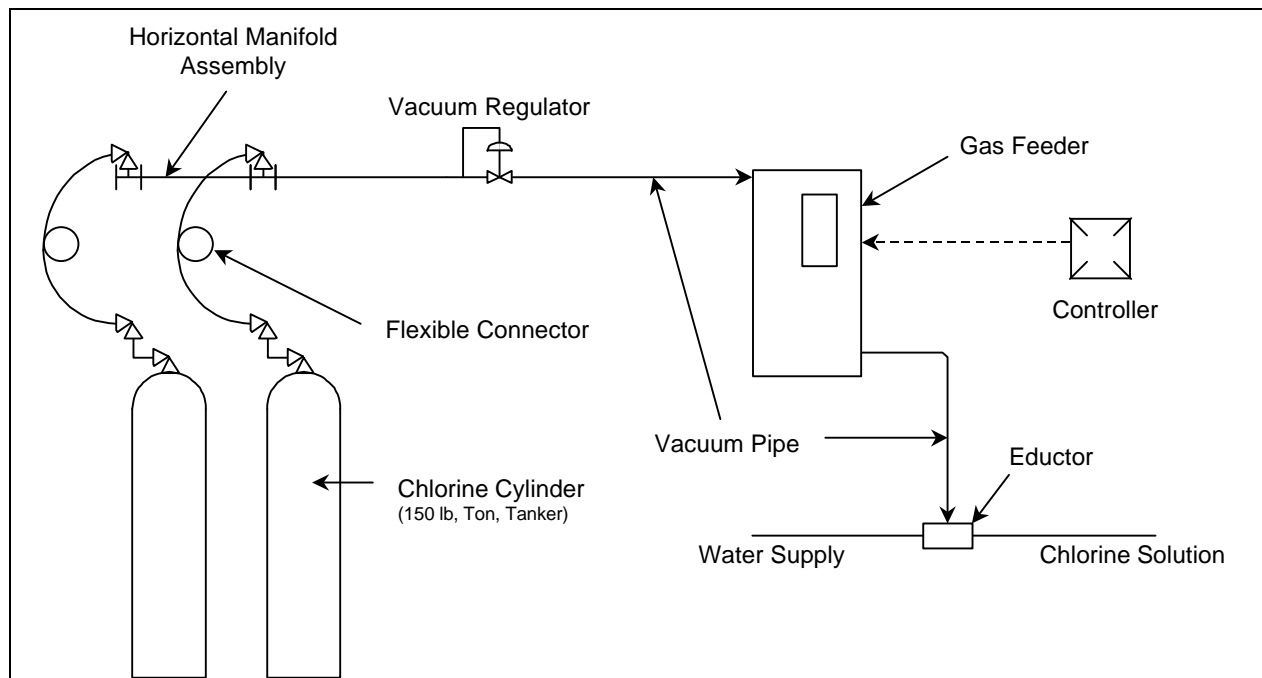
Table 6-3 summarizes commonly used methods of chlorine addition, including their safety precautions and costs.

**Table 6-3. Methods of Chlorine Addition**

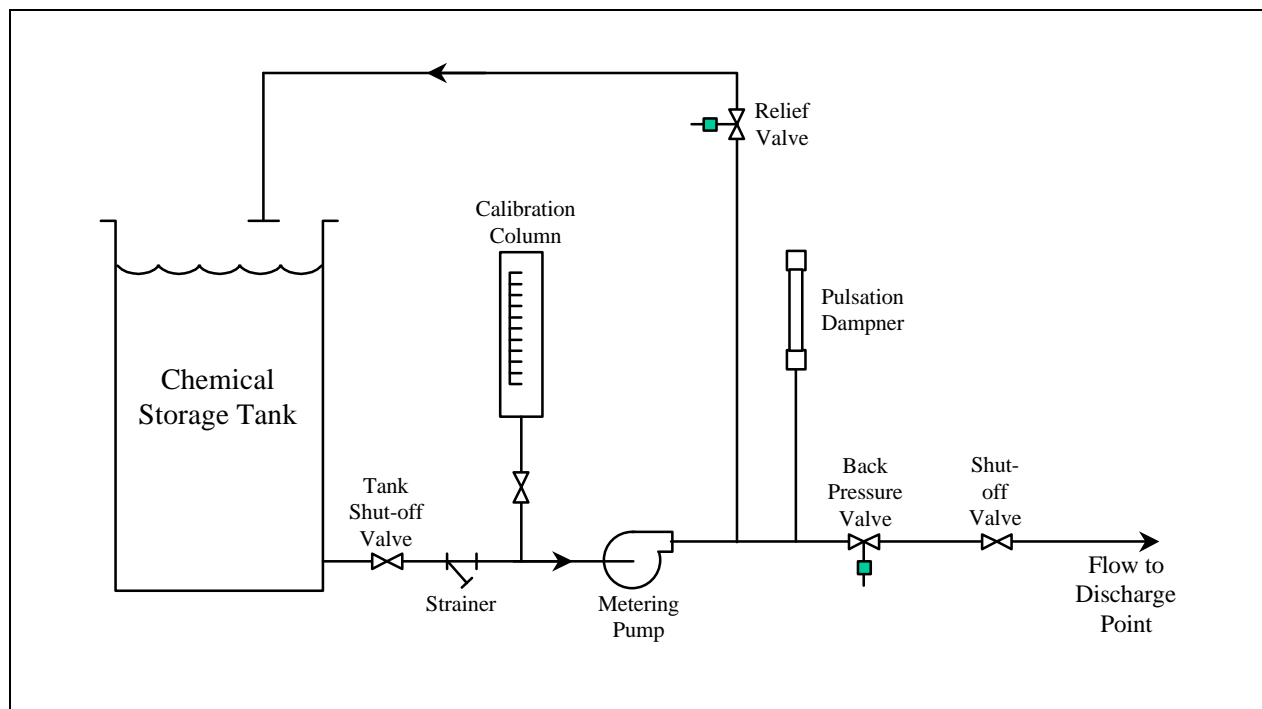
Method	Description	Safety precautions	Costs
Gaseous chlorine	Gas delivered in containers ranging in size from 150 lb cylinders to 90 ton rail cars. One ton cylinders are commonly used. Feed equipment consists of solution water pump/ejector to create vacuum and automatic orifice control to meter the gas. Gas can be drawn directly from storage container or be generated by an evaporator from liquid withdrawn from the container. A schematic of gaseous chlorine feed system is shown in Figure 6-3.	Gaseous chlorine is classified by the Uniform Fire Code as an oxidizing, highly toxic, compressed gas. New gaseous chlorine facilities should be designed with enclosures and air scrubbers to capture and neutralize any gas that leaks. Risk management prevention plans should be prepared. Personnel safety equipment and training should be provided for operators.	The cost per pound of liquid chlorine is in the range of \$0.08 to \$0.20 per pound depending on the quantity purchased.
Sodium hypochlorite	Sodium hypochlorite can be purchased bulk in quantities ranging from 55 gal drums to 4,500 gal truck loads. Bulk loads can be stored in fiberglass or plastic tanks. Solution is fed directly into the process stream. A schematic of typical hypochlorite feed system is shown in Figure 6-4.	Hypochlorite solution is toxic and classified as hazardous. Storage facilities should be designed with secondary containment.	Typical chemical cost is \$0.60 to \$1.00 per pound Cl <sub>2</sub> .

## 6.2.2 Ammonia Feed Facilities

Ammonia feed facilities can be located on-site at the water treatment plant or at remote locations in the distribution system (Dennis et al., 1991). Most ammonia feed facilities use either gaseous (anhydrous ammonia) or liquid (aqueous) ammonia. Though anhydrous ammonia is a gas at ambient temperature and pressure, it is commonly stored and transported as a liquid in pressure vessels. In this phase, ammonia is highly soluble in water. Storage facilities and handling equipment should be kept dry (Dennis et al., 1991).



**Figure 6-3. Gaseous Chlorine Feed System**



**Figure 6-4. Hypochlorite Feed System**

### 6.2.2.1 Anhydrous Ammonia

Anhydrous ammonia is stored in portable cylinders or stationary tanks. Portable cylinders are similar to chlorine cylinders and are available in 100, 150, and 800 lb sizes (Dennis et al., 1991). The cylinders are rated for a minimum service pressure of 480 psi. Stationary tanks are typically 1,000 gallon vessels that can be used on-site. These tanks are refilled by tanker trailers. The storage tanks can be located indoors or outdoors. Since each tank has a minimum working pressure of 250 psi (valves and fittings on the tanks are rated for 300 psi), a tank stored outdoors should have protection from extreme temperatures (greater than 125°F and less than 28°F) (Dennis et al., 1991). In warmer climates, an outdoor tank should be painted white and protected from sunlight. In colder climates, the tank should be wrapped with heat tape to prevent impairment of the ammonia vaporization.

Anhydrous ammonia is applied using an ammoniator. An ammoniator is a self-contained modular unit with a pressure reducing valve, gas flow meter, feed rate control valve, and miscellaneous piping for controlling the flow of ammonia. Automatic paced ammoniators are available. An evaporator is used when large quantities of ammonia gas are needed. An anti-siphon valve or check valve should be used to prevent water from entering the ammoniator.

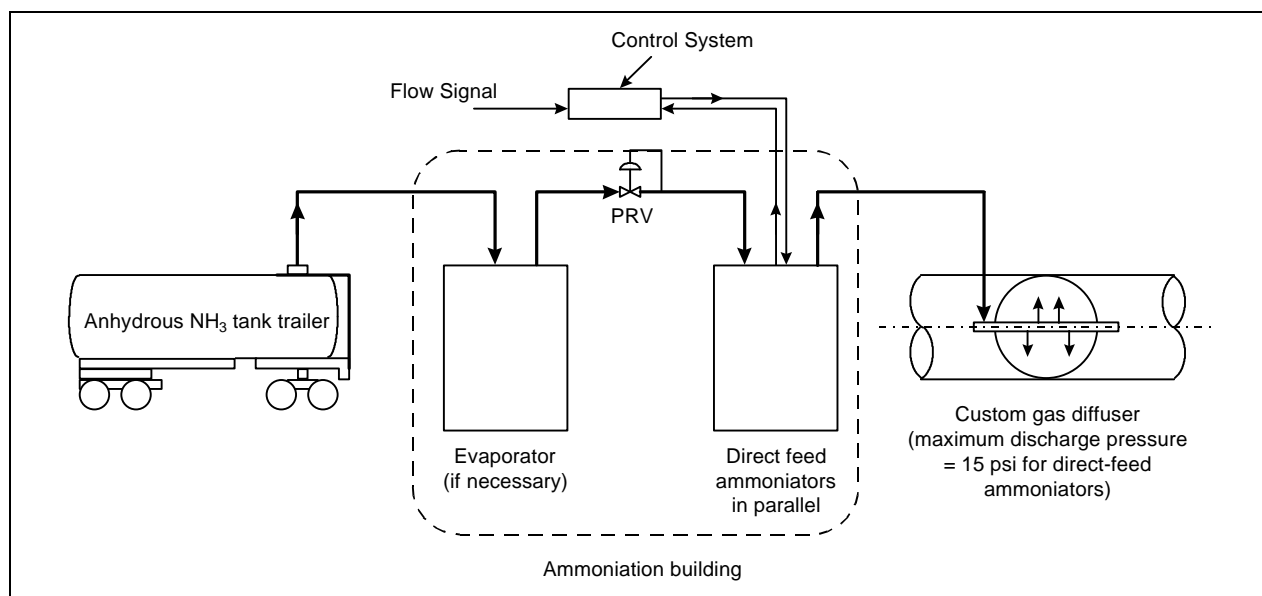
Anhydrous ammonia is usually applied by direct feed or solution feed. The direct feed method is typically used when the process stream has a low pressure and the ammonia feed rate is less than 1,000 lb per day (i.e., maximum rated feed capacity). Ammonia is drawn from the storage tank under high pressure (e.g., 200 psi), and injected directly into the process stream at a low pressure of 15 psi. The tank pressure is first reduced by a pressure reducing valve to approximately 40 psi, and

then by another pressure reducing valve in the ammoniator. Typical application points are at open channels and basin facilities. Figure 6-5 is a schematic of a direct anhydrous ammonia feed system.

The solution feed method is typically used where direct feed systems are not adequate (e.g., ammonia feed rate is greater than 1000 lb/day or where the process stream pressure is high) (Dennis et al., 1991). This type of application is similar to the chlorine vacuum feed system. The supply tank pressure is reduced by a pressure reducing valve to create a vacuum. An eductor is used to withdraw ammonia from the ammoniator where the ammonia is dissolved into a side water stream and pumped into the process stream. Solution feed ammoniators are available up to 4,000 lb/day capacities and can operate at discharge pressures up to 100 psi (Dennis et al., 1991). Softened water (i.e., hardness less than 29 mg/L as CaCO<sub>3</sub>) is required for the carrier stream. Otherwise, the ammonia addition will precipitate scale that may plug the eductor and application point. Figure 6-6 shows a schematic of a solution feed system.

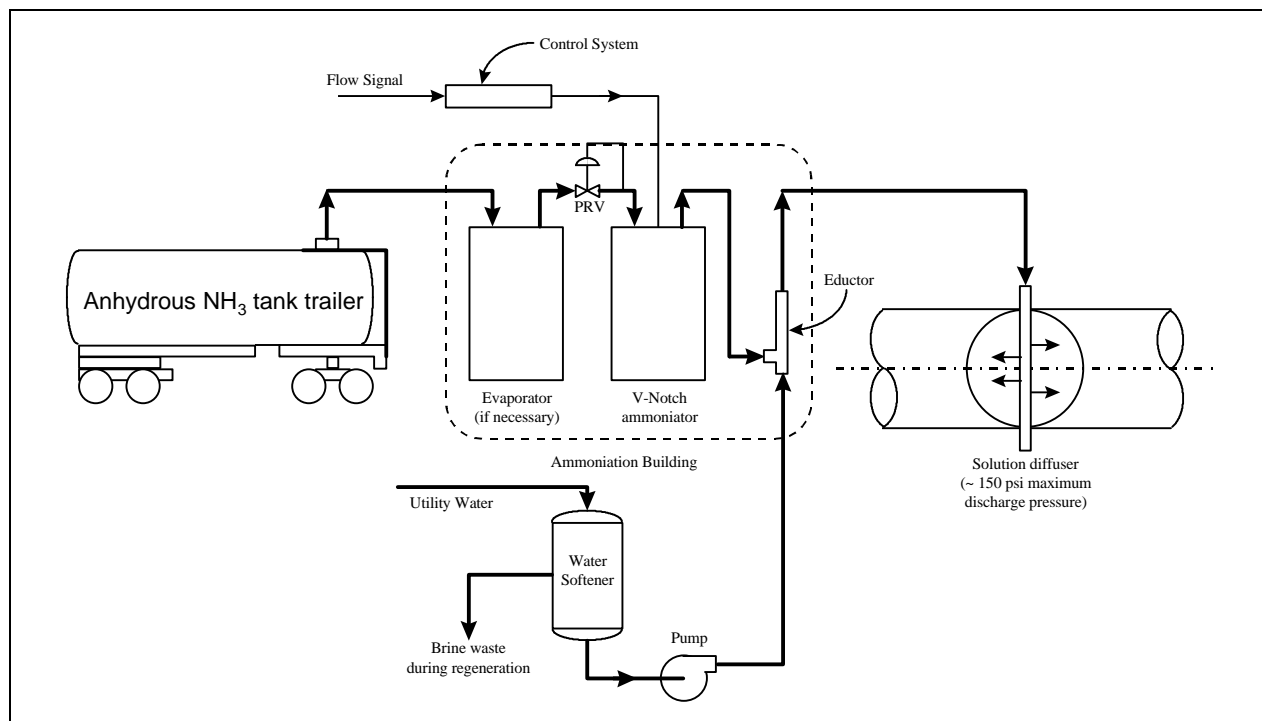
### 6.2.2.2 Aqueous Ammonia

Aqueous ammonia is produced by dissolving anhydrous ammonia into deionized or softened water. This form of ammonia is shipped in cargo trucks or polyethylene lined steel drums. Plastic drums are not recommended since they tend to lose their shape under the slight pressure exerted by the aqueous ammonia. Aqueous ammonia is stored in low pressure tanks, typically steel or fiberglass. Since excessive temperatures will cause ammonia gas to vaporize, each storage tank should be equipped with a water trap or ammonia scrubber to keep vapors from escaping to the atmosphere.



Source: Montgomery, 1985.

**Figure 6-5. Anhydrous Ammonia Direct Feed System**

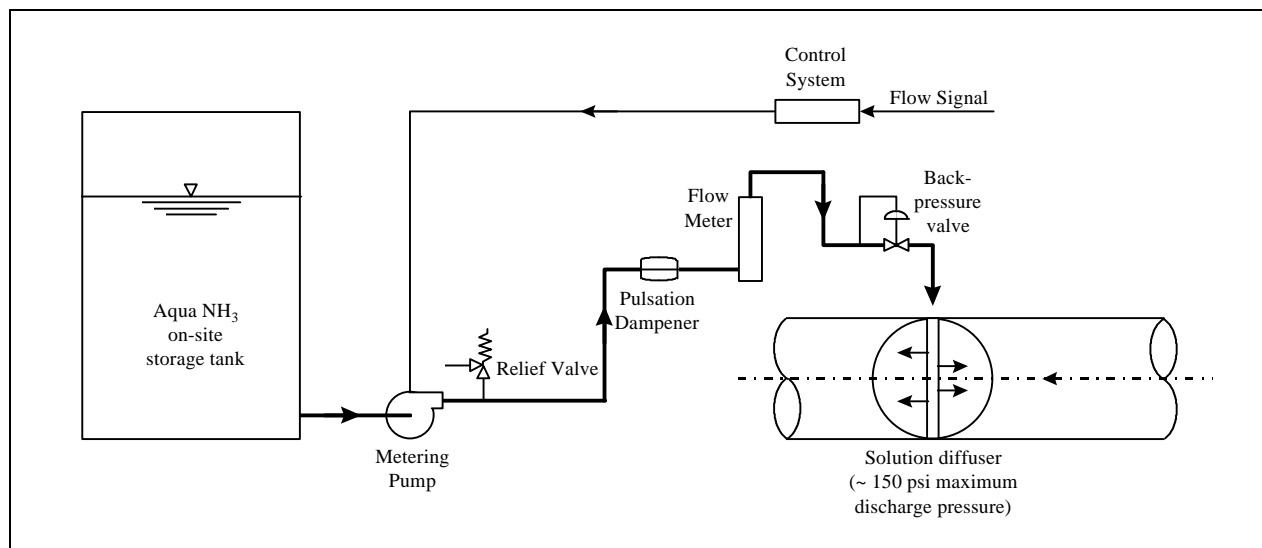


Source: Montgomery, 1985.

**Figure 6-6. Anhydrous Ammonia Solution Feed System**

Aqueous ammonia feed systems are similar to other liquid chemical feed systems. They require a storage tank, chemical metering pump, relief valve, pulsation dampener, flow meter, and backpressure valve. Typically, the feed pumps are positive displacement or progressive cavity type metering pumps. The feed pumps should be placed fairly close to the storage tank to minimize chances of ammonia vaporization in the piping (Dennis et al., 1991). The pump should be designed to compensate for changes in ambient temperatures, different aqueous ammonia solutions, and changes in the chlorine-to-ammonia ratio (Skadsen, 1993). When aqueous ammonia is applied to water, complete mixing is required for the ammonia to react with chlorine in the water to reduce the formation of dichloramine and nitrogen trichlorine. Figure 6-7 shows a schematic of an aqua ammonia feed system.

Metropolitan Water District of Southern California (MWDSC) uses aqueous ammonia at its chloramination facility. Ammonia is stored in unlined tanks and pumped to the ammoniator with progressive cavity pumps. During startup of its aqueous ammonia feed system, MWDSC experienced complete pump failures. Based on MWDSC's experience, EPDM rotors with adequate quality chromed finish stators are recommended for progressive cavity pumps. A mechanical seal is also recommended instead of a packing box to reduce the possibility of ammonia leaks (Skadsen, 1993). MWDSC also later installed special blow-offs and strainers in the feed pump suction line to reduce plugging at the magnetic flow meters. The pump problems prior to startup led MWDSC to install an alternative, redundant ammonia feed system. A pressurized system was designed to feed aqueous ammonia by pressurizing the ammonia tanks and by-passing the pump.



Source: Montgomery, 1985.

**Figure 6-7. Aqua Ammonia Feed System**

A 5.5 gpm flexible impeller centrifugal pump with a recirculation loop back to the storage tank regulates the back pressure on the by-passed feed pump. This alternative, redundant method proved to be reliable and economical. In addition, it provided a stable feed rate and required little maintenance (Skadsen, 1993).

### 6.2.2.3 Piping and Valving

For anhydrous ammonia, the typical piping materials for both direct and solution feed systems are stainless steel, PVC, and black iron (Dennis et al., 1991). Stainless steel or black iron pipe is used in the high pressure (i.e., greater than 15 psi) portions of the feed system. PVC pipe is used only in the low pressure portion of the feed system, after the ammoniators.

For aqueous ammonia, PVC piping should be used due to the corrosive nature of aqueous ammonia (Dennis et al., 1991).

### 6.2.2.4 Safety Provisions for Chloramine Generation Facilities

A chloramination facility should include some safety provisions to prevent the formation of nitrogen trichloride and the vaporization of ammonia at ambient temperatures. The possible formation of nitrogen trichloride at a chloramination facility should be considered when selecting sites for the ammonia and chlorine storage facilities.

Dennis et al. (1991) provides detailed information about safety provisions for chloramine facilities. Chlorine gas and ammonia gas should never be stored in the same room. The ammonia gas application points should be located at least 5 feet away from chlorine feed solution lines. Anhydrous ammonia is lighter than air, so any leaking vapor will rise quickly. Under pressure, anhydrous ammonia is a liquid. Great amounts of heat are absorbed when the pressurized liquid reverts to a gas.

If the storage tanks and/or chemical feed equipment are installed indoors, ventilation and vapor detection devices should be located at high points in the room. The ventilation rates will vary depending on the appropriate regulatory agency's requirements. Typically, a minimum of 6 room volume changes per minute is recommended.

Ammonia gas storage tanks should be protected from direct sunlight or direct sources of heat (i.e., greater than 125°F) to avoid pressure increases in the tank (Dennis et al., 1991). Otherwise, ammonia gas may be released into the atmosphere through the pressure relief valves. In warm regions, outdoor tanks should be covered with a shelter or outfitted with a temperature control sprinkler system. Where fugitive emissions of ammonia are a concern, fume control may be required. If the accidental release from a storage container is a concern, an emergency scrubber system similar to a chlorine gas scrubber system should be considered.

## 6.3 Primary Uses and Points of Application

Monochloramine is used in drinking water treatment for disinfection and nuisance organism control. Points of application are based on treatment objectives and contact time disinfection requirements.

### 6.3.1 Primary Uses

#### 6.3.1.1 Disinfection

The primary use of monochloramine in water systems is as a secondary disinfectant for maintaining a residual in the distribution system. Chloramines are a good choice for secondary disinfectant because of the following potential benefits:

- Chloramines are not as reactive with organics as free chlorine in forming THMs.
- The monochloramine residual is more stable and longer lasting than free chlorine or chlorine dioxide, providing better protection against bacterial regrowth in systems with large storage tanks and dead-end water mains.
- The monochloramine residual has been shown to be more effective in controlling biofilms because of its superior ability to penetrate the biofilm. Controlling biofilms also tends to reduce coliform concentrations and biofilm induced corrosion.
- Because chloramines do not tend to react with organic compounds, many systems will experience less incidence of taste and odor complaints when using chloramines.

Water systems in Indiana and Virginia found that conversion from free chlorine to monochloramine as the secondary disinfectant significantly reduced coliform concentrations in the distribution system (Norton and LeChevallier, 1997).

The normal dosage range for monochloramine is in the range of 1.0 to 4.0 mg/L. The minimum residual of monochloramine in the distribution system is typically regulated at 0.5 mg/L (Texas

Natural Resource Conservation Commission). For prevention of nitrification in a distribution system, a minimum monochloramine dosage of 2.0 mg/L is recommended (Norton and LeChevallier, 1997).

### **6.3.1.2 Nuisance Organism Control**

Cameron et al. (1989a) investigated the effectiveness of monochloramine to control the Asiatic clam in both the juvenile and adult phases. The adult Asiatic clam was found to be much more resistant to monochloramine than the juvenile form. Monochloramine was found to be the most effective for controlling the juvenile Asiatic clam in terms of  $LT_{50}$  (time required for 50 percent mortality). Monochloramine doses used to control the juvenile Asiatic clam range from 1.2 to 4.7 mg/L. Further research showed that the effectiveness of monochloramine increased greatly as the temperature increased (Cameron et al., 1989b).

## **6.3.2 Points of Application**

The formation of monochloramine can be accomplished by first adding ammonia and then chlorine, or vice versa. Ammonia is added first where formation of objectionable taste and odor compounds caused by the reaction of chlorine and organic matter are a concern. However, most drinking water systems add chlorine first in the treatment plant in order to achieve the required concentration and contact time (CT) to meet EPA's SWTR disinfection requirements. Typically, the point of ammonia addition is selected to "quench" the free chlorine residual after a target period of time based on optimizing disinfection versus minimizing DBP formation.

Because the germicidal effectiveness of monochloramine is a factor of 200 less than for free chlorine, extremely long contact times are required for monochloramine to meet EPA disinfection CT requirements. Therefore, if ammonia is added first, a means of ensuring that CT requirements are met must be developed.

### **6.3.2.1 Impact on Other Treatment Processes**

Monochloramine addition impacts other processes at the water treatment facility. These impacts include:

- Ammonia used in the chloramination process can provide nutrient ammonia for nitrifying bacteria growth in the distribution system, which can cause increased nitrate levels in the finished water where systems do not normally test for nitrate.
- Imbalances in chlorine and ammonia concentrations (in greater than an 8 to 1 ratio) can cause breakpoint chlorination reactions to occur when encountered in distribution system
- Monochloramine addition upstream of filters will reduce biological growth on filters. This has a favorable impact on the filters by keeping them clean and reducing the backwash frequency. It also has the undesirable impact of reducing BDOC removal in the filters when the filters are run in a biological mode.

The reader is referred to EPA's *Microbial and Disinfection Byproduct Simultaneous Compliance Guidance Document* (expected to be available in 1999) for additional information regarding the interaction between oxidants and other treatment processes.

## 6.4 Pathogen Inactivation and Disinfection Efficacy

Chloramination of drinking water has been practiced in the United States for nearly 80 years. In addition to achieving disinfection, chloramines have been used by the Denver Water Department for controlling tastes and odors since 1918 (Hazen and Sawyer, 1992). Chloramination has also been found to provide a more stable residual in water distribution system. However, because of its relatively weak disinfecting properties for inactivation of viruses and protozoa pathogens, it is rarely used as a primary disinfectant, and then only with long contact times.

### 6.4.1 Inactivation Mechanisms

The mechanisms by which chloramines inactivate microorganisms have been studied to a lesser degree than chlorine. A study of inactivation of *E. coli* by chloramines concluded that monochloramine readily reacts with four amino acids; cysteine, cystine, methionine and tryptophan (Jacangelo et al., 1987). The mechanism of inactivation for chloramine is therefore thought to involve inhibition of proteins or protein mediated processes such as respiration. Jacangelo further concluded that because of the inconsistency in rate of inactivation monochloramine should have "multiple hits" upon bacterial cells before cell death.

Few studies have been performed to determine the mechanism for viral inactivation. The initial site for destruction of bacteriophage f2 involved the RNA fragment (Olivieri et al., 1980). However, the primary mechanism for poliovirus inactivation by chloramines involved the protein coat (Fujioka et al., 1983). Similar to free chlorine, the mechanism of viral inactivation by chloramine may be dependent on factors such as virus type and disinfectant concentration.

### 6.4.2 Environmental Effects

Several studies have been performed to determine the effect of pH, temperature, and organic and inorganic compounds on the disinfection effectiveness of chloramines. Following is a summary of the affect these parameters have on pathogen inactivation.

#### 6.4.2.1 pH

The effect of pH on disinfection has more to do with the organism than with the disinfectant; however, pH also impacts disinfection efficiency by controlling the chloramine species distribution. Studies have indicated that the disinfection efficacy of monochloramine and dichloramine are not equal. One study showed that the bactericidal properties of dichloramine were superior to that of monochloramine (Esposito, 1974). However, pH may be a compounding factor because changes in pH may alter the physiological response of the organism (Hoff and Geldreich, 1981). Other studies

have shown that monochloramine is superior to dichloramine with regard to virucidal ability (Dorn, 1974; Esposito, 1974; Olivieri et al., 1980). Some evidence suggests that solutions containing approximately equal concentrations of monochloramine and dichloramine may be more microbiocidal than those containing only monochloramine or dichloramine (Weber and Levine, 1944).

#### **6.4.2.2 Temperature**

Similar to most of the disinfectants discussed in this report, the bactericidal and viral inactivation efficiency of chloramine increases with increasing temperature. Moreover, the efficiency dramatically decreases under conditions of high pH and low temperature. For example, the inactivation of *E. coli* is approximately 60 times slower at pH 9.5 and temperatures of 2 and 6°C than at pH 7 and temperatures between 20 and 25°C (Wolfe et al., 1984). Similar results were obtained for poliovirus 1 inactivation (Kelley and Sanderson, 1958).

#### **6.4.2.3 Organic Nitrogen and Other Compounds**

In addition to ammonia, free chlorine reacts with organic nitrogen compounds to form a variety of organic chloramines. These organic chloramines are undesirable byproducts because they exhibit little or no microbiocidal activity (Feng, 1966). Studies have indicated that chlorine binds to amine-containing compounds more rapidly than to ammonia (Weil and Morris, 1949; Morris, 1967; Margerum et al., 1978) and that chlorine can be transferred from inorganic chloramines to amine-containing compounds (Margerum et al., 1978; Isaac and Morris, 1980)

Several other reactions may occur which divert chlorine from the formation of chloramines. These reactions can include oxidation of iron, manganese, and other inorganics such as hydrogen sulfide (Hazen and Sawyer, 1992).

### **6.4.3 Disinfection Efficacy**

Chloramines are relatively weak disinfectants for virus and protozoa inactivation. As a consequence, it is extremely difficult to meet the SWTR CT criteria for primary disinfection of *Giardia* and viruses using chloramines because very long detention times are needed. However, given the ability of chloramines to provide a stable residual, this form of disinfection appears to be feasible for secondary disinfection protection against microbial growth in distribution systems. The following paragraphs describe the disinfection efficiency of chloramines in terms of bacteria, virus, and protozoa inactivation.

#### **6.4.3.1 Bacteria Inactivation**

A series of comprehensive experiments was initiated in the mid 1940s to determine the relative bactericidal effectiveness of free chlorine and inorganic chloramines. Results from these experiments showed conclusively that under relatively demand-free, laboratory-controlled conditions, free chlorine inactivated enteric bacteria much faster than chloramines (Wattie and

Butterfield, 1944). In this experiment, a monochloramine concentration of 0.3 mg/L required 240 minutes of contact time for 3-log inactivation of *E. coli* whereas exposure to 0.14 mg/L free Cl<sub>2</sub> required only 5 minutes to achieve the same level of inactivation at the same temperature and pH.

#### **6.4.3.2 Virus Inactivation**

According to reports written by Kabler et al. (1960) and the National Research Council (1980), all studies conducted prior to 1944 that compared virucidal potency of free and combined chlorine were inaccurate because the experiments failed to clearly differentiate between free and combined forms of chlorine and because high-chlorine-demand water was used in the experiments.

The majority of the experiments conducted after the mid-1940s has shown that inorganic chloramines require much higher concentrations and considerably longer contact times than free chlorine to achieve comparable levels of virus inactivation. Experiments showed that contact times between 2 and 8 hours were required at concentrations between 0.67 to 1.0 mg chloramines to achieve greater than 2-log inactivation of poliovirus 1 (Mahoney and MK500), poliovirus 2 (MEF), poliovirus 3 (Sackett), coxsackievirus B1, and coxsackievirus B5 (EA 80) (Kelley and Sanderson, 1958 and 1960). In contrast, 0.2 to 0.35 mg/L free Cl<sub>2</sub> required 4 to 16 minutes of contact time to achieve comparable levels of inactivation under the same conditions.

#### **6.4.3.3 Protozoa Inactivation**

Of the three predominant forms of pathogens (i.e., bacteria, viruses, and protozoan [oo]cysts), studies have shown that protozoan [oo]cysts are usually the most resistant to all forms of disinfection. Studies have indicated that free chlorine is a more effective disinfectant than chloramines for [oo]cyst inactivation (Chang and Fair, 1941; Chang, 1944; Stringer and Kruse, 1970). Chloramine concentrations of 8 mg/L were required for 2-log inactivation of *Entamoeba histolytica* cysts whereas only 3 mg/L of free chlorine was required to obtain the same degree of inactivation (Stringer and Kruse, 1970). Contact times for both disinfectants were 10 minutes.

#### **6.4.3.4 CT Values**

CT values for achieving *Giardia* cyst and virus inactivation using chloramines are shown in Table 6-4 and Table 6-5, respectively. Values contained in these tables were obtained from the *Guidance Manual for Compliance with Filtration and Disinfection Requirements for Public Water Systems Using Surface Water Sources* (AWWA, 1991).

CT values shown in Table 6-4 are based on disinfection studies using in vitro excystation of *Giardia lamblia*. CT values shown in Table 6-5 were based on data using preformed chloramines at pH 8. No safety factor was applied to laboratory data used to derive the CT values shown in Table 6-4 and Table 6-5 since chloramination conducted in the field is more effective than using preformed chloramines, since monochloramine tends to degrade with time and some free chlorine is present when forming chloramines which enhances the inactivation process.

**Table 6-4. CT Values for *Giardia* Cyst Inactivation Using Chloramines**

Inactivation	Temperature (°C) (mg•min/L)				
	5	10	15	20	25
0.5-log	365	310	250	185	125
1-log	735	615	500	370	250
1.5-log	1,100	930	750	550	375
2-log	1,470	1,230	1,000	735	500
2.5-log	1,830	1,540	1,250	915	625
3-log	2,200	1,850	1,500	1,100	750

Source: AWWA, 1991.

Values shown in this table are based on a pH range between 6 and 9.

**Table 6-5. CT Values for Virus Inactivation Using Chloramines**

Inactivation	Temperature (°C) (mg•min/L)				
	5	10	15	20	25
2-log	857	643	428	321	214
3-log	1,423	1,067	712	534	356
4-log	1,988	1,491	994	746	497

Source: AWWA, 1991.

## 6.5 DBP Formation

The effectiveness of chloramines to control DBP production depends upon a variety of factors, notably the chlorine-to-ammonia ratio, the point of addition of ammonia relative to that of chlorine, the extent of mixing, and pH.

Monochloramine (NH<sub>2</sub>Cl) does not produce DBPs to any significant degree, although some dichloroacetic acid can be formed from monochloramine and cyanogen chloride formation is greater than with free chlorine (Jacangelo et al., 1989; Smith et al., 1993; Cowman and Singer, 1994). The inability to mix chlorine and ammonia instantaneously allows the free chlorine to react before the complete formation of chloramines. In addition, monochloramine slowly hydrolyzes to free chlorine in aqueous solution. Therefore, halogenation reactions occur even when monochloramine is formed prior to addition in the treatment process (Rice and Gomez-Taylor, 1986). The closer the chlorine:ammonia ratio is to the breakpoint, the greater the formation of DBPs (Speed et al., 1987). In addition to controlling the formation of DBPs, chloramination results in lower concentrations of a number of the other specific organic halides generated from free chlorine, except for cyanogen chloride (Krasner et al., 1989; Jacangelo et al., 1989). Increased production of cyanogen chloride is observed when monochloramine is used as a secondary disinfectant instead of free chlorine.

The application of chloramines results in the formation of chlorinated organic material, although it occurs to a much lesser degree than from an equivalent dose of free chlorine. Little is known about the nature of these byproducts, except that they are more hydrophilic and larger in molecular size than the organic halides produced from free chlorine (Jensen et al., 1985; Singer 1993).

## 6.6 Status of Analytical Methods

### 6.6.1 Monitoring of Chloramines

There has been little development of analytical procedures for selective determination of monochloramines (Gordon, et al., 1992). Typically, the methods used for chlorine residual measurement are adapted for chloramine measurement. The DBPR promulgated on December 16, 1998 (63 FR 69390) establishes three analytical methods that are acceptable for measuring residual chloramines (combined chlorine). These methods are presented in 40 CFR § 141.131(c) and include:

- Amperometric Titration (Standard Method 4500-Cl D and ASTM Method D 1253-86);
- DPD Ferrous Titrimetric (Standard Method 4500-Cl F); and
- DPD Colorimetric (Standard Method 4500-Cl G).

If approved by the State, systems may also measure chloramines by using DPD colorimetric test kits.

#### 6.6.1.1 Amperometric Titrations

The amperometric titration method is utilized extensively in water treatment laboratories (Gordon, et al., 1992). This method capable of differentiating the three most common forms of chlorine, namely chlorine/hypochlorous acid/hypochlorite ion, monochloramine, and dichloramine, as long as the combined forms are not present in concentrations greater than about 2 mg/L (as Cl<sub>2</sub>). For higher concentrations, dilution of the samples is required, but differentiation is still possible (Aoki, 1989).

The amperometric titration method is a standard of comparison for the determination of free or combined chlorine. This method is not greatly affected by common oxidizing agents, temperature variations, turbidity, and color (Standard Methods, 1995). Amperometric titration requires a greater degree of skill than colorimetric methods. The differentiation of free chlorine, monochloramine, and dichloramine is possible by control of potassium iodide (KI) concentration and pH during the analysis.

Several methods are commonly used to measure chlorine species utilizing the amperometric titration including forward and back titration (Gordon, et al., 1992). The lower limit of detection of these methods varies depending on the instrumentation used and type of water sample analyzed. The lower limit of detection for commercial amperometric titrating equipment is about 30 µg/L as Cl<sub>2</sub> (Sugam, 1983).

Table 6-6 shows the working range, expected accuracy and precision, operator skill level required, interferences, and current status for amperometric method monochloramine analysis comparison.

### **6.6.1.2 Colorimetric Methods**

Over the years, numerous colorimetric methods have been developed to measure free and combined chlorine in aqueous solutions (Gordon, et al., 1992). Not many of these methods would be recommended as the method of choice. Two of the colorimetric methods listed in Standard Methods (1995), are DPD methods. In addition, the colorimetric LCV method modified by Whittle and Lapteff (1974) can be used to measure free and combined chlorine species.

The DPD methods (ferrous titration and colorimetric) are operationally simpler for determining free chlorine than the amperometric titration (Standard Methods, 1995). Procedures are given for estimating separate monochloramine and dichloramine fractions, as well as combined chlorine fractions.

The LCV method modified by Whittle and Lapteff modifies the discontinued Standard Method for LCV. The maximum chlorine concentration that can be determined by this modified procedure, without dilution of the sample, is 10 mg/L as Cl<sub>2</sub> (Whittle and Lapteff, 1974).

See Table 6-6 for the working range, expected accuracy and precision, operator skill level required, interferences and current status for colorimetric method monochloramine analysis comparison.

### **6.6.2 Disinfectant Interferences**

Interferences to free chlorine may impact the measurement of monochloramine since the methods use the free chlorine level in the determination of monochloramine. Many strong oxidizing agents interfere in the measurement of free chlorine in all monochloramine methods, including bromine, chlorine dioxide, iodine, permanganate, hydrogen peroxide, and ozone. However, the reduced form of these compounds (i.e. bromide ion, chloride ion, iodide ion, manganous ion, and oxygen) do not interfere. Reducing agents such as ferrous compounds, hydrogen sulfide, and oxidizable organic matter generally do not interfere (Standard Methods, 1995).

**Table 6-6. Characteristics and Comparisons of Monochloramine<sup>a</sup> Analytical Methods**

Type of Test	Working Range (mg/L)	Expected Accuracy ( $\pm$ %)	Expected Precision ( $\pm$ %)	Skill Level <sup>b</sup>	Interferences	pH Range	Field Test	Automated Test	Current Status
Amperometric Titration, Forward	0.1 - 10	NR	0 - 10	2	dichloramine, nitrogen trichloride,	pH dependent	Yes	Yes	Recommended
Amperometric Titration, Back	0.1 - 10	NR	NF	2	dichloramine, nitrogen trichloride,	pH dependent	Yes	Yes	Recommended
Colorimetric DPD Ferrous Titration	0.01 - 10	NR	2 - 7	1	dichloramine, nitrogen trichloride, oxidizing species	Requires buffer	No	No	Recommended Lab Test
Colorimetric DPD	0.01 - 10	NR	5 - 75	1	dichloramine, nitrogen trichloride, oxidizing species	Requires buffer	Yes	No	Recommended Field Test

Source: Gordon et al., 1992.

Notes: <sup>a</sup> Little actual work has been carried out on selective determination of chloramines. The values reported are from extrapolated studies that had objectives other than the selective determination of chloramines.

<sup>b</sup> Operator skill levels: 1 = minimal, 2 = good technician, 3 = experienced chemist. NR = Not reported in literature cited by referenced source.

### 6.6.2.1 *Amperometric Titrations*

The amperometric titration methods are unaffected by dichloramine concentrations in the range of 0 to 9 mg/L as Cl<sub>2</sub> in the determination of free chlorine. Nitrogen trichloride, if present, may react partially as free chlorine. The amperometric method will measure organic chloramines as free chlorine, monochloramine, or dichloramine, depending upon the activity of chlorine in the organic sample (Standard Methods, 1995). Dichloramine may also interfere with the measurement of both monochloramine and free chlorine (Marks, et al., 1951). The presence of iodide ion can be a severe problem if the titrator glassware is not washed carefully between determinations (Johnson, 1978).

Manganese dioxide, a common interference in most chlorine analytical procedures, does not interfere in the amperometric measurement of free chlorine (Bongers et al., 1977). However, because of its reaction with iodide ion, added during analysis, manganese dioxide does interfere with the amperometric measurement of combined forms of chlorine such as monochloramine (Johnson, 1978).

### 6.6.2.2 *Colorimetric Methods*

Sample color and turbidity may interfere in all colorimetric procedures. In the DPD colorimetric methods, high concentrations of monochloramine interfere with free chlorine determination unless arsenite or thioacetamide are added. In addition, the DPD methods are subject to interference by oxidized forms of manganese unless compensated for by a blank (Standard Methods, 1995). The DPD methods are unaffected by dichloramine concentrations in the range of 0 to 9 mg/L as Cl<sub>2</sub> in the determination of free chlorine. Nitrogen trichloride, if present, may react partially as free chlorine. The extent of this interference in the DPD methods does not appear to be significant (Standard Methods, 1995).

In the LCV colorimetric method, Whittle and Lapteff (1974) reported that dichloramine did not interfere with the monochloramine measurement.

## 6.6.3 Chloramine Monitoring for Systems Using Chloramines

Pursuant to 40 CFR §141.132(c)(1), community water systems and non-transient non-community water systems that use chloramines, must measure the residual disinfectant level at the same points in the distribution system, at the same time, and at the same frequency (based on population served) as total coliforms are sampled, as specified in 40 CFR §141.21. These systems may use the results of residual disinfectant concentration sampling conducted under §141.74(b)(6)(i) for unfiltered systems or §141.74(c)(3)(i) for systems which filter, in lieu of taking separate samples. No reduced monitoring allowances exist for these systems.

Compliance with the MRDL of 4.0 mg/L (as chlorine) is based on a running annual arithmetic average, computed quarterly, of monthly averages of all samples collected by the system under §141.132(c)(1). If the average quarterly averages covering any consecutive four-quarter period exceeds the MRDL, the system is in violation of the MRDL and must notify both the public, pursuant

to §141.32, and the State, pursuant to §141.134. Where systems switch between the use of chlorine and chloramines for residual disinfection during the year, compliance is determined by including together all monitoring results of both chlorine and chloramines in calculating compliance.

## 6.7 Operational Considerations

The purpose of this section is to address operational considerations in the use of chloramines in drinking water treatment. Specifically, the following topics are addressed below: the conversion of chloramination from chlorination; the potential operational impacts from chloramination disinfection; and special considerations for chloramination facilities. For a more detailed discussion of chloramine disinfection, refer to “Optimizing Chloramine Treatment” by Kirmeyer et al. 1993.

### 6.7.1 Conversion to Chloramination from Chlorination

#### 6.7.1.1 Planning

Project planning and preparation are essential to ensure an efficient changeover, maintain a dependable and safe system, and preserve the public confidence in the water purveyor (Skadsen, 1993). Planning and preparation should consider the following aspects:

- Raw water composition and suitability to chloramination;
- Treatment plant and distribution system attributes and monitoring program;
- Employee training;
- Public notification and education; and
- Environmental affects from chloraminated water.

#### 6.7.1.2 Preliminary Analysis

A bench scale study is necessary to identify the water characteristics and to determine if chloramination is suitable. White (1992) describes some of the study objectives and variables to consider. The reaction time to form free chloramine residuals varies for each water source since the reaction rate between chlorine and ammonia nitrogen depends on the water’s temperature and pH of the water. The reaction rate is also affected by the chlorine and ammonia nitrogen concentrations. To properly control the reaction time between chlorine and ammonia, the study should use different chlorine:ammonia nitrogen ratios, ammonia feed doses, and contact times.

The amount of ammonia required for chloramine residual disinfection depends on the following factors (Dennis et al., 1991):

- Organic nitrogen in the water;
- Ammonia residual desired in the distribution system; and

- Chloramine residual type and concentration required in the distribution system.

If there is organic nitrogen in the untreated water, the amount of supplemental ammonia required should be carefully determined by subtracting the background ammonia from the desired dose. The dose should also consider the amount of ammonia residual desired in the distribution system. For residual disinfection, approximately 1 to 2 mg/L of ammonia is required (Dennis et al., 1991).

For each specific water, a breakpoint curve should be developed to determine the chloramine residual type required. Monochloramine residuals are preferred for most water distribution systems. Dichloramine and nitrogen trichloride residuals may cause taste and odor problems when concentrations exceed 0.8 mg/L or 0.02 mg/L, respectively. Monochloramines are primarily formed when the theoretical chlorine to ammonia dose ratio is less than 5 to 1 (by weight ratio) and the pH is greater than 7.0 (Dennis et al., 1991). The chloramine residual concentration leaving the treatment plant will vary depending on the size of the distribution system and the chloramine demand exerted by the system. Typical chloramine residuals range from 1 to 4 mg/L (Dennis et al., 1991).

### **6.7.1.3 The Metropolitan Water District (MWDSC)**

MWDSC of Southern California converted from free chlorine to chloramine disinfection in 1985 to assist its 27 member agencies in complying with the EPA's total trihalomethane regulation. MWDSC serves approximately 15 million people and operates five treatment plants, with a combined capacity of 1,670 MGD. Raw water is taken from two sources: the Colorado River and California state project water.

Prior to the changeover, MWDSC performed extensive investigations into the chemical, microbiological, and engineering aspects of chloramine disinfection. To prepare for the changeover, MWDSC coordinated the efforts among its treatment plants, distribution system reservoirs, laboratory personnel, and management. A formal request for approval to use chloramines as a disinfectant was submitted to the California State Department of Health Services. Next, a series of workshops was held on the engineering, chemical, and microbiological aspects of chloramine disinfection. MWDSC also prepared a manual for the type of chloramination application method and ammonia form selected. Information in the manual included the feed equipment information, project specifications, piping layouts, preliminary analysis, and safety and maintenance issues.

It was essential to notify specific sectors of the public that could be affected by the use of chloramines. MWDSC made its customers aware of the changeover and kept them apprised of the options for preventing adverse reactions through an extensive notification program that involved state and county health departments, appropriate interest groups, and the media.

## 6.7.2 Potential Operational Impacts from Chloramination Disinfection

### 6.7.2.1 Pretreatment

Ammonia in excess of the required chlorine can promote the growth of nitrifying bacteria in filter beds (i.e., rapid sand filters) (White, 1992). The excess ammonia acts as a nutrient and causes the growth of nitrifying bacteria, which convert the excess ammonia to nitrates and nitrites. Excessive levels of nitrate in drinking water have caused serious illness and sometimes death in infants under six months of age. The symptoms include shortness of breath and blueness of skin [40 CFR §141.32(e)(20)]. Prior to designing a chloramination facility, the amount of ammonia naturally occurring in the raw water should be determined. The required ammonia dosage would then be based on the anticipated naturally occurring ammonia levels.

A chloramine residual concentration should also be maintained in the discharge stream from the filters. An adequate residual concentration would be between 0.5 to 1 mg/L chloramine (White, 1992).

### 6.7.2.2 Nitrification

Nitrification in chloraminated drinking waters is usually partial. Partial nitrification occurs when the chloraminated water has excess ammonia present in the distribution system (Skadsen, 1993). Partial nitrification can have various adverse effects on water quality, including a loss of total chlorine and ammonia residuals and an increase in heterotrophic plate count (HPC) bacteria concentration. The excess ammonia encourages the growth of nitrifying bacteria that convert ammonia to nitrates. An intermediate step in this conversion results in a small amount of nitrite being formed. Research has shown that a chlorine demand of 5 mg/L is exerted by 1 mg/L of nitrite (Cowman and Singer, 1994). The nitrites rapidly reduce free chlorine, accelerate decomposition of chloramines, and can interfere with the measurement of free chlorine (Skadsen, 1993). Valentine (1998) found that the decay of monochloramine was increased (from a second order rate constant of 0.07 to 0.106) by the presence of 0.5 mg/L of nitrite. If nitrification episodes are allowed to continue, very low (or zero) total chlorine residual concentration levels may occur. Loss of chlorine residual allows an increase in HPC bacteria and potentially increases in total coliforms and may result in a positive sample (Cowman and Singer, 1994). Additional information on nitrification can be found in (Kirmeyer et al. 1995), "Nitrification Occurrence and Control in Chloraminated Water Systems."

**Factors.** Several possible factors have been implicated as contributing to nitrification. These factors include low chlorine-to-ammonia ratio, long detention times, and temperatures (Cowman and Singer, 1994). Though some articles noted that low monochloramine dosages may lead to nitrification, other research has reported nitrification occurring at monochloramine concentrations greater than 5.0 mg/L (Cowman and Singer, 1994). Nitrifying bacteria are relatively more resistant to disinfection by monochloramine than free chlorine (Cowman and Singer, 1994). The optimum conditions for nitrification would be a water system with free-ammonia, a pH of 7.5 to 8.5, a water temperature of

25 to 30°C, and a dark environment. Nitrifying bacteria exhibit slow growth and have been found in higher numbers in the sediment of distribution systems than in the biofilm (Cowman and Singer, 1994).

If the water reservoirs in the distribution system are covered, partial nitrification may occur (White, 1992). Nitrification occurred in two of MWDSC's covered reservoirs (Garvey and Orange County reservoirs) after the changeover. Approximately 10 weeks after the changeover from chlorine to chloramine, water quality degradation was occurring in the Garvey Reservoir. MWDSC increased the amounts of free chlorine added to the plant effluent to maintain a 1.5 mg/L monochloramine residual at the reservoir effluent and the chlorine to ammonia ratio was increased from 3:1 to 4:1 to decrease the amount of excess ammonia in the water. These changes were more effective than the flushing programs for the distribution system, which only helped temporarily.

**Control Measures.** Nitrification may pose a potential problem for any utility using monochloramine as a disinfectant (Cowman and Singer, 1994). Thus, nitrification should be carefully assessed and controlled. Nitrification may be controlled by monitoring at strategic locations throughout the distribution system for monochloramine and dichloramine residuals (White, 1992).

The chloramine free residual stability is increased throughout the distribution system when there is increased control of microbial contaminants and decreased bacterial concentrations in the raw water to acceptable levels. Recommended approaches to prevent and control nitrification in the distribution system include (Cowman and Singer, 1994):

- Decreasing the detention time;
- Increasing the pH;
- Decreasing the temperature;
- Decreasing TOC concentrations;
- Increasing chloramines residual;
- Increasing the chlorine-to-ammonia ratio; and
- Decreasing the excess ammonia concentration.

For the distribution system, the system should be evaluated to identify the low-flow or dead-end sections. The detention times in the system should be operationally minimized (Skadsen, 1993). For reservoirs, those with single inlet-outlet configurations should especially be carefully monitored and operated (Skadsen, 1993).

MWDSC stresses the importance of developing nitrification strategy control measures. In particular, a comprehensive monitoring program should be established to alert personnel to implement control measures when required. To control nitrification, MWDSC developed a control strategy where the reservoirs and distribution system were first sampled for nitrite levels (Skadsen, 1993). MWDSC

also decreased the detention times in reservoirs and distribution systems, especially during warmer weather, which helped to keep nitrite levels down.

The chloramination operation was modified to add more chlorine to the reservoir inlet and increase the chlorine-to-ammonia ratio from 3:1 to 5:1 at the plant effluent. The initial 3:1 ratio corresponded with a 1.5 mg/L monochloramine residual and 0.2 mg/L excess ammonia. At these concentrations, the agencies receiving the water had the flexibility of blending the chloraminated water with chlorinated water or adding more chlorine to those sections of the system with long detention times. Increasing the ratio further to 5:1 controlled the nitrification problem by decreasing the amount of free ammonia in the distribution system. Operating at a 5:1 ratio requires more monitoring since an overdose of chlorine can reduce the chloramine residual.

A survey of chloramine users in the United States was conducted in June 1991. This survey showed that the chlorine to ammonia ratio varied from 3:1 to 7:1 (Dennis, et al, 1991). The chloramine residual varied from 0.8 mg/L to 3 mg/L (Dennis, et al, 1991). Table 6-7 shows the results from this survey. The agencies surveyed reported excellent results with secondary chloramine disinfection (Dennis et al, 1991). EPA is in the process of collecting and evaluating chloramine use in the United States as part of the Information Collection Rule (ICR), but until those data are available, the 1991 survey appears to be the most recent national survey of chloramine use.

Each year, MWDSC also added chlorine past the breakpoint to allow a free residual for 30 days. The ideal locations for breakpoint chlorination are at the distribution reservoirs and interconnections. The increased chlorine oxidizes any nitrite and nitrifying bacteria and eliminates the excess ammonia in the distribution system. For larger water systems, MWDSC recommends maintaining chlorination stations throughout the distribution system. Both fixed and mobile chlorinators may be used. Mobile chlorinator units are self-contained and trailer-mounted with evaporators, chlorinators, generator, a booster pump for transport water, and chlorine injectors. They are designed to draw liquid chlorine directly from a 17-ton chlorine trailer and to inject a chlorine solution into the distribution system or reservoir.

Since nitrifying bacteria were found in higher numbers in the sediments of the distribution system than in the biofilm, flushing sediment from the system will help to control nitrification. The addition of a disinfectant (i.e., free or combined chlorine) is required to remove nitrification.

At the Indiana American Water Company, the distribution system is temporarily converted back to free chlorine for scheduled flushing (Lyn et al., 1995). Utilities should evaluate their flushing program to avoid consumer complaints with inappropriate flushing techniques.

### **6.7.2.3 Taste and Odor**

If the chlorine to ammonia-nitrogen ratios are between 3:1 and 5.5:1, disagreeable tastes and odors should be evaluated at the consumer tap (White, 1992).

Fishy tastes and odors (e.g., from source waters and return washwater from the washwater treatment system) can be controlled by a 1-hour contact time with free-chlorine residual of 2 mg/L prior to the addition of ammonia (Dennis et al., 1991). This prechlorination eliminates the fishy taste and odor but may increase the THM concentrations at the plant effluent.

**Table 6-7. Survey of Chloramine Users in the United States**

Agency	Treatment Capacity	Type of Ammonia	Chlorine: Ammonia Nitrogen ratio	Chloramine Residual (mg/L)	NH <sub>3</sub> Injection Point	Nitrification Control Strategies
City of Dallas, TX	730 mgd; 3 plants	Anhydrous	5:1	2.1 - 2.3	Presedimenta-tion, Post-filtration	None
City of Denver, CO	600 mgd; 3 plants	Aqueous (30%)	3:1	0.8 - 1.0	Post-filtration, prior to chlorine addition	None
Indianapolis, Water Co., IN	176 mgd; 4 plants	Anhydrous	3:1 varies	1.5 - 2.0	Post-filtration	Increase ratio in summer
Miami-Dade Water Authority, FL	300 mgd; 3 plants	Anhydrous	5:1	2.7 - 3.0	10 ft after chlorine flash mix	2 weeks free chlorine every November
City of Milwaukee, WI	305 mgd; 2 plants	Anhydrous	5:1	0.8 - 0.9	Post-filtration	None
City of Philadelphia, PA	530 mgd; 3 plants	Aqueous (30%)	3:1	2.0	Post-filtration	None
City of Portland, OR	225 mgd	Anhydrous	7:1	1.8	70 ft downstream of chlorine in conduit	None
Orleans Parish, LA	300 mgd; 2 plants	Anhydrous	3:1	2.0 - 2.5	Pre-filtration	None
St. Louis Co. Water Authority, MO	360 mgd; 4 plants	Aqueous (30%)	4:1	2.5	Concurrent with chlorine at flash mix, post-filtration	None

Source: Dennis et al., 1991.

## 6.7.3 Special Considerations for Chloramination Facilities

### 6.7.3.1 GAC Filters with Ammonia Addition

The Ann Arbor Water Treatment Plant in Michigan is a 50 mgd lime softening plant that draws its water from the Huron River (80 to 90 percent) and ground water (10 to 20 percent). When chloramination is applied to the river water, the chlorine is injected into the raw water line

immediately before ammonia is applied. The total chlorine feed averages 3.3 mg/L with an average demand of 2.0 mg/L for the river water.

Evidence of nitrification occurred immediately after a change in treatment from sand to GAC filtration. Prior to the change to GAC, the treatment plant had successfully used monochloramine as both a primary and a final disinfectant. Nitrification was not evident. The GAC received an application of approximately 1.3 mg/L ammonia. This input of ammonia to the filters constituted a nutrient source that allowed nitrifying bacteria to become established and proliferate. The GAC particles have been observed to harbor nitrifying bacteria and nitrification has been observed in GAC beds. Higher nitrifying bacteria levels have been observed in other filter beds as compared with source water. The GAC effluent also showed pronounced seasonal peaks in HPC bacteria from May to July, and percent total coliforms positive from July to August. These seasonal peaks are most probably temperature related. During periods of nitrification, GAC effluent HPC bacteria concentration was steadily decreasing while in the distribution system, HPC bacteria were increasing.

### **6.7.3.2 Organic Nitrogen**

Concentrations of organic nitrogen and ammonia nitrogen as low as 0.3 mg/L may interfere with the chloramination process. The monochloramine residuals will hydrolyze with the organic nitrogen to form organochloramines, which are nongermicidal. This reaction would take about 30 to 40 minutes. After the monochloramine residuals disappear, free ammonia nitrogen reappears. Free ammonia nitrogen is a powerful biological nutrient. Its presence promotes biological instability in that portion of the distribution system. Biological instability usually results in foul tastes and odors plus dirty and/or colored water at the consumers tap (White, 1992).

The free chlorine residual or chloramine residual method may be used to clean an area with biological instability. Of the two methods, the free chlorine residuals method is superior (White, 1992). Free chlorine residuals restore distribution system stability quicker (i.e., a few days for free chlorine versus weeks for chloramines), the clean-up process can be monitored, and the clean-up is complete when the free chlorine residual concentration reaches 85 percent of the free chlorine concentration.

Based on their conversion to chloramination experience, MWDSC recommends that utilities employing chloramines for disinfection monitor for total organic nitrogen levels. When levels are high, the amino acid fraction is also likely to rise. This rise may impair the chloramination disinfection efficiency if high levels of organic nitrogen are not detected.

### **6.7.3.3 Mixing**

Mixing at the point of application greatly affected the bactericidal efficiency of the chloramine process. When the pH of the water is between 7 and 8.5, the reaction time between ammonia and chlorine is practically instantaneous. If chlorine is mixed slowly into the ammoniated water, organic matter, especially organic matter prone to bleaching with chlorine solution, may react with the chlorine and interfere with chloramine formation (White, 1992).

#### **6.7.3.4 Blending Waters**

When chlorinated water is blended with chloraminated water, the chloramine residual will decrease after the excess ammonia has been combined and monochloramine is converted to dichloramine and nitrogen trichloride. The entire residual can be depleted. Therefore, it is important to know how much chlorinated water can be blended with a particular chloraminated water stream without significantly affecting the monochloramine residual. Blended residual curves should be developed for each specific blend.

#### **6.7.3.5 Corrosion**

Chloramination and corrosion control can limit bacterial biofilm development in the distribution system. If optimum corrosion of iron pipes is not controlled, the chloramination efficiency may be impacted. Corrosion inhibitors with higher phosphate concentrations may reduce corrosion rates (Lyn et al., 1995).

#### **6.7.3.6 Formation of Nitrogen Trichloride**

If water in the distribution system tends to form nitrogen trichloride, the finished water should be subjected to post-aeration, which readily removes nitrogen trichloride (White, 1992). Nitrogen trichloride is also readily destroyed by sunlight (White, 1992).

#### **6.7.3.7 Human Health and the Environment**

Users of kidney dialysis equipment are the most critical group that can be impacted by chloramine use. Chloramines can cause methemoglobinemia and adversely affect the health of kidney dialysis patients if chloramines are not removed from the dialysate water. Chloramines can also be deadly to fish. The residuals can damage the gill tissues, enter the red blood cells, and cause an acute blood disorder. Chloramine residuals should be removed from the water prior to the water contacting any fish. As such, fish hobbyists should be notified, along with pet stores and aquarium supply establishments.

## **6.8 Summary**

### **6.8.1 Advantages and Disadvantages of Chloramine Use**

The following list highlights selected advantages and disadvantages of using chloramines as a disinfection method for drinking water (Masschelein, 1992). Because of the wide variation of system size, water quality, and dosages applied, some of these advantages and disadvantages may not apply to a particular system.

#### **Advantages**

- Chloramines are not as reactive with organics as free chlorine in forming DBPs.

- The monochloramine residual is more stable and longer lasting than free chlorine or chlorine dioxide, thereby providing better protection against bacterial regrowth in systems with large storage tanks and dead end water mains. However excess ammonia in the network may cause biofilming.
- Because chloramines do not tend to react with organic compounds, many systems will experience less incidence of taste and odor complaints when using chloramines.
- Chloramines are inexpensive.
- Chloramines are easy to make.

### Disadvantages

- The disinfecting properties of chloramines are not as strong as other disinfectants, such as chlorine, ozone, and chlorine dioxide.
- Chloramines cannot oxidize iron, manganese, and sulfides.
- When using chloramine as the secondary disinfectant, it may be necessary to periodically convert to free chlorine for biofilm control in the water distribution system.
- Excess ammonia in the distribution system may lead to nitrification problems, especially in dead ends and other locations with low disinfectant residual.
- Monochloramines are less effective as disinfectants at high pH than at low pH.
- Dichloramines have treatment and operation problems.
- Chloramines must be made on-site.

### 6.8.2 Summary Table

Table 6-8 summarizes the considerations for the use of chloramine.

**Table 6-8. Summary of Chloramine Disinfection**

Consideration	Description
Generation	<p>Chloramines are generated by the sequential addition of chlorine (hypochlorous acid) and ammonia at a <math>\text{Cl}_2</math> to <math>\text{NH}_3</math> ratio ranging from 3:1 to 5:1. Either chlorine or ammonia may be added first. Chlorine is normally added first to act as the primary disinfectant and after 10 to 30 minutes, ammonia is added to prevent further formation of DBPs.</p> <p>The most common methods of chlorine addition include gas feed using a dilution water reduction system or direct feed of bulk hypochlorite solution (12 percent typical commercial strength).</p> <p>The most common ammonia feed facilities include anhydrous ammonia fed either directly or via a dilution water reduction system or direct feed of bulk aqua ammonia solution (20 percent typical commercial strength).</p>
Primary uses	<p>Monochloramine is used primarily as a secondary disinfectant to provide a residual in the distribution system. It is used where elevated DBPFP levels in the treated water can cause high levels of DBP formation in the distribution system if free chlorine is used as the secondary disinfectant. Monochloramine has been found to be more effective than free chlorine in controlling biofilms and coliform bacteria in systems with long detention times due to the lower decay rate of chloramine. Monochloramine will have much less tendency to react with organics present and hence will form less taste and odor causing compounds.</p>
Inactivation efficiency	<p>At pH 7 and below, free chlorine is 200, 200, 50, and 2.5 times more effective in inactivating bacteria, viruses, spores, and cysts respectively than monochloramine.</p>
Byproduct formation	<p>Monochloramine substantially reduces the DBP formation but still forms some DBPs.</p>
Limitations	<p>Monochloramine is increasingly being used as a secondary disinfectant to provide a residual in distribution systems because of its lower decay rate than free chlorine and lesser tendency to form DBPs.</p> <p>Caution should be used in using monochloramine in distribution systems where water sources using free chlorine residual are also used. High <math>\text{Cl}_2</math> to N ratios can occur where waters using different residuals combine leading to the possible formation of taste and odor causing dichloramine and nitrogen trichloride. In some cases the residual may be completely removed by the breakpoint reaction.</p>
Point of application	<p>Monochloramine is normally generated at the treatment facility with the addition of ammonia to chlorinated water. Ammonia is normally added prior to the pumping into the distribution system. In some cases, ammonia is added prior to the clearwell to minimize formation of DBPs by free chlorine residual.</p>
Special considerations	<p>Nitrification and generation of bacterial growths can occur if the <math>\text{Cl}_2</math> to N ratio is too low and conditions exist for the growth of nitrifying bacteria. A minimum residual of 2.0 mg/L of monochloramine has been found effective in controlling nitrification in most systems.</p>

## 6.9 References

1. Aoki, T. 1989. "Continuous Flow Method For Simultaneous Determination Of Monochloramine, Dichloramine, and Free Chlorine: Application To A Water Purification Plant." *Environ. Sci. Technol.* 23:46-50.

2. AWWA (American Water Works Association). 1991. Guidance Manual for Compliance with the Filtration and Disinfection Requirements for Public Works Systems Using Surface Water Sources.
3. AWWA and ASCE (American Society of Civil Engineers). 1990. *Water Treatment Plant Design*, second edition. McGraw-Hill, Inc. New York, NY.
4. Bongers, L.H., T.P O'Connor, and D.T. Burton. 1977. "Bromine Chloride-An Alternative To Chlorine For Fouling Control in Condenser Cooling Systems." EPA 600/7-77-053, Washington, D.C.
5. Cameron, G.N., J.M. Symons, S.R. Spencer, and J.Y. Ma. 1989a. "Minimizing THM Formation During Control of the Asiatic Clam: A Comparison of Biocides." *J. AWWA*. 81(10):53-62.
6. Cameron, G.N., J.M. Symons, D. Bushek, and R. Kulkarni. 1989b. "Effect of Temperature and pH on the Toxicity of Monochloramine to the Asiatic Clam." *J. AWWA*. 81(10):63-71.
7. Chang, S.L. 1944. "Studies on *Entamoeba histolytica* 3. Destruction of Cysts of *Entamoeba histolytica* by Hypochlorite Solution, Chloramines in Tap Water and Gaseous Chlorine in Tap Water of Varying Degrees of Pollution." *War Med*. 5:46.
8. Chang, S.L. and G.M. Fair. 1941. "Viability and Destruction of the Cysts of *Entamoeba histolytica*." *J. AWWA*. 33(10):1705.
9. Cowman, G.A., and P.C. Singer. 1994. "Effect of Bromide Ion on Haloacetic Acid Speciation Resulting from Chlorination and Chloramination of Humic Extracts." Conference proceedings, AWWA Annual Conference, New York, NY.
10. Dennis, J.P., D.C. Rauscher, and D.A. Foust. 1991. "Practical Aspects of Implementing Chloramines." Conference proceedings, AWWA Annual Conference, Philadelphia, PA.
11. Dorn, J. M. 1974. *A Comparative Study of Disinfection on Viruses and Bacteria by Monochloramine*. Master's thesis, Univ. Cincinnati, Ohio.
12. Esposito, M.P. 1974. *The Inactivation of Viruses in Water by Dichloramine*. Master's thesis, Univ. Cincinnati, Ohio.
13. Feng, T.H. 1966. "Behavior of Organic Chloramines." *J. Water Pollution Control Fed*. 38(4):614.
14. Fujioka, R.S., K.M. Tenno, and P.C. Loh. 1983. "Mechanism of Chloramine Inactivation of Poliovirus: A Concern for Regulators." *Water Chlorination: Environmental Impacts and Health Affects*, Vol. 4, R.L. Jolley, et al. (editor). Ann Arbor Science Publishers, Inc., Ann Arbor, MI.

15. Gordon, G., W.J. Cooper, R.G. Rice, and G.E. Pacey. 1992. *Disinfectant Residual Measurement Methods*. Second Edition, AWWARF and AWWA.
16. Haas, C. N. and R.S. Engelbrecht. 1980. "Chlorine Dynamics During Inactivation of Coliforms, Acid-Fast Bacteria and Yeasts." *Water Res.* 14:1744.
17. Hazen and Sawyer. 1992. *Disinfection Alternatives For Safe Drinking Water*. Van Nostrand Reinhold, New York, NY.
18. Hoff, J.C. and E.E. Geldreich. 1981. "Comparison of the Biocidal Efficiency of Alternative Disinfectants." *J. AWWA.* 73(1):40.
19. Isaac, R.A. and J.C. Morris. 1980. "Rates of Transfer of Active Chlorine Between Nitrogenous Substances." *Water Chlorination: Environmental Impact and Health Effects*, Vol. 3. R.L. Jolley (editor). Ann Arbor Science Publishers, Inc., Ann Arbor, MI.
20. Jacangelo, J.G., Olivieri, V.P., and Kawata, K., 1987. "Mechanism of Inactivation of Microorganisms by Combined Chlorine." AWWA Research Foundation, Denver, CO.
21. Jacangelo, J.G., N.L. Patania, K.M. Reagan, E.M. Aieta, S.W. Krasner, and M.J. McGuire. 1989. "Impact of Ozonation on the Formation and Control of Disinfection *Byproducts* in Drinking Water." *J. AWWA.* 81(8):74.
22. Jensen, J., J. Johnson, J. St. Aubin, R. Christman. 1985. "Effect of Monochloramine on Isolated Fulvic Acid." *Org. Geochem.* 8(1):71.
23. Johnson, J.D. 1978. "Measurement and Persistence of Chlorine Residuals." Natural Waters. In *Water Chlorination: Environmental Impact and Health Effects*. R.L. Jolley (editor). Ann Arbor Science Publishers, Inc., Ann Arbor, MI. 1:37-63.
24. Kabler, P.W., et al. 1960. "Viricidal Efficiency of Disinfectants in Water." *Public Health Repts.* 76(7):565.
25. Kelley, S.M. and W.W. Sanderson. 1958. "The Affect of Chlorine in Water on Enteric Viruses." *Amer. Jour. Publ. Health.* 48:1323.
26. Kelley, S.M. and W.W. Sanderson. 1960. "The Effect of Chlorine in Water on Enteric Viruses 2, The Effect of Combined Chlorine on Poliomyelitis and Cocksackie Viruses." *Amer. Jour. Publ. Health.* 50(1):14.
27. Kirmeyer, G., et al. 1993. *Optimizing Chloramine Treatment*. AWWARF.
28. Kirmeyer, G., et al. 1995. *Nitrification Occurrence and Control in Chloraminated Water Systems*. AWWARF.

29. Krasner, S.W., M.J. McGuire, and J.J. Jacangelo. 1989. "The Occurrence of Disinfection Byproducts in U.S. Drinking Water." *J. AWWA*. 81(8):41.
30. Lyn, T.L., S.R. Lavinder, and R. Hungate. 1995. "Design Considerations for Ammoniation Facilities." Conference proceedings, AWWA Annual Conference, Anaheim, CA.
31. Margerum, D.W., et al. 1978. "Chlorination and the Formation of N-Chloro Compounds in Water Treatment." *Organometals and Organometal-loids: Occurrence and Fate in the Environment*. R. F. Brinckman and J. M. Bellama (editors). ACS (American Cancer Society), Washington, D.C.
32. Marks, H.C., D.B. Williams, and G.U. Glasgow. 1951. "Determination of Residual Chlorine Compounds." *J. AWWA*. 43:201-207.
33. Masschelein, W.J. 1992. "Unit Processes in Drinking Water Treatment." Marcel Decker D.C., New York, Brussels, Hong Kong.
34. Montgomery, J.M. 1985. *Water Treatment Principles and Design*. John Wiley & Sons, Inc., New York, NY.
35. Morris, J.C. 1967. "Kinetics of Reactions Between Aqueous Chlorine and Nitrogen Compounds." *Principles and Applications of Water Chemistry*. S.D. Faust and J.V. Hunter (editor). John Wiley & Sons, New York, NY.
36. NRC (National Research Council). 1980. *Drinking Water and Health*, Vol. 2. National Academy Press, Washington, D.C.
37. Norton, C.D. and M.W. LeChevallier. 1997. "Chloramination: Its Effect on Distribution System Water Quality." *J. AWWA*. 89(7):66.
38. Olivieri, V.P., et al. 1980. "Reaction of Chlorine and Chloramines with Nucleic Acids Under Disinfection Conditions." *Water Chlorination: Environmental Impact and Health Effects*, Vol. 3. R.J. Jolley (editor), Ann Arbor Science Publishers, Inc., Ann Arbor, MI.
39. Palin, A. 1950. "A Study of the Chloro Derivatives of Ammonia." *Water and Water Engineering*. 54:248-258.
40. Rice, R. and M. Gomez-Taylor. 1986. "Occurrence of By-Products of Strong Oxidants Reacting with Drinking Water Contaminants - Scope of the Problem." *Environ. Health Perspectives*. 69:31.
41. Singer, P.C. 1993. "Trihalomethanes and Other Byproducts Formed From the Chlorination of Drinking Water." National Academy of Engineering Symposium on Environmental Regulation: Accommodating Changes in Scientific, Technical, or Economic Information, Washington, D.C.

42. Skadsen, J. 1993. "Nitrification in a Distribution System." *J. AWWA*. 95-103.
43. Smith, M.E., Cowman, G.A., Singer, P.C. 1993. "The Impact of Ozonation and Coagulation on DBP Formation in Raw Waters." Conference proceedings, AWWA Annual Conference, San Antonio, TX.
44. Speed, M.A., et al. 1987. *Treatment Alternatives for Controlling Chlorinated Organic Contaminants in Drinking Water*. EPA/60012-87/011, Washington, D.C.
45. Standard Methods. 1995. *Standard Methods for the Examination of Water and Wastewater*, nineteenth edition, Franson, M.H., Eaton, A.D., Clesceri, L.S., and Greenberg, A.E., (editors). APHA (American Public Health Association), AWWA, and Water Environment Federation, Washington D.C.
46. Stringer, R. and C.W. Kruse. 1970. "Amoebic Cysticidal Properties of Halogens." Conference proceedings, National Specialty Conference on Disinfection, ASCE, New York.
47. Sugam, R. 1983. "Chlorine Analysis: Perspectives For Compliance Monitoring." *Water Chlorination, Environmental Impact and Health Effects*. R.L. Jolley, et al. (editor). Ann Arbor Science Publishers, Ann Arbor, MI.
48. Valentine, R.L. et al. 1998. "Chloramine Decomposition in Distribution System and Model Waters." AWWA, Denver, CO.
49. Wattie, E. and C.T. Butterfield. 1944. "Relative Resistance of *Escherichia coli* and *Eberthella typhosa* to Chlorine and Chloramines." *Public Health Repts*. 59:1661.
50. Weber, G.R. and M. Levine. 1944. "Factors Affecting the Germicidal Efficiency of Chlorine and Chloramine." *Amer. J. Public Health*: 32:719.
51. Weil, I. and J.C. Morris. 1949. "Kinetic Studies on the Chloramines. The Rates of Formation of Monochloramine, N-Chlormethylamine and N-Chlordimethylamine." *J. Amer. Chem. Soc.* 71:1664.
52. White, G.C. 1992. *Handbook Of Chlorination and Alternative Disinfectants*. Volume 3. Van Nostrand Reinhold Co., New York, NY.
53. Whittle, G.P. and Lapteff, A., Jr. 1974. "New Analytical Techniques For The Study Of Water Disinfection." *Chemistry of Water Supply, Treatment, and Distribution*. A.J. Rubin (editor) Ann Arbor Science Publishers, Inc., Ann Arbor, MI.
54. Wolfe, R.L., N.R. Ward, and B.H. Olson. 1984. "Inorganic Chloramines as Drinking Water Disinfectant: A Review." *J. AWWA*. 76(5):74-88.

THIS PAGE INTENTIONALLY LEFT BLANK

<b>CHLORAMINES</b> .....	<b>6-1</b>
6.1 CHLORAMINES CHEMISTRY .....	6-1
6.1.1 Equilibrium, Kinetic, and Physiochemical Properties .....	6-1
6.2 GENERATION.....	6-3
6.2.1 Chlorine Feed Facilities .....	6-4
6.2.2 Ammonia Feed Facilities .....	6-5
6.3 PRIMARY USES AND POINTS OF APPLICATION .....	6-10
6.3.1 Primary Uses .....	6-10
6.3.2 Points of Application .....	6-11
6.4 PATHOGEN INACTIVATION AND DISINFECTION EFFICACY .....	6-12
6.4.1 Inactivation Mechanisms .....	6-12
6.4.2 Environmental Effects .....	6-12
6.4.3 Disinfection Efficacy .....	6-13
6.5 DBP FORMATION .....	6-15
6.6 STATUS OF ANALYTICAL METHODS.....	6-16
6.6.1 Monitoring of Chloramines.....	6-16
6.6.2 Disinfectant Interferences .....	6-17
6.6.3 Chloramine Monitoring for Systems Using Chloramines .....	6-19
6.7 OPERATIONAL CONSIDERATIONS.....	6-20
6.7.1 Conversion to Chloramination from Chlorination.....	6-20
6.7.2 Potential Operational Impacts from Chloramination Disinfection .....	6-22
6.7.3 Special Considerations for Chloramination Facilities.....	6-25
6.8 SUMMARY .....	6-27
6.8.1 Advantages and Disadvantages of Chloramine Use .....	6-27
6.8.2 Summary Table .....	6-28
6.9 REFERENCES .....	6-29
Table 6-1. Chlorine Dose Required for NH <sub>3</sub> - Cl <sub>2</sub> Reaction .....	6-3
Table 6-2. Time to 99 Percent Conversion of Chlorine to Monochloramine .....	6-4
Table 6-3. Methods of Chlorine Addition.....	6-4
Table 6-4. CT Values for <i>Giardia</i> Cyst Inactivation Using Chloramines .....	6-15
Table 6-5. CT Values for Virus Inactivation Using Chloramines .....	6-15
Table 6-6. Characteristics and Comparisons of Monochloramine <sup>a</sup> Analytical Methods.....	6-18
Table 6-7. Survey of Chloramine Users in the United States.....	6-25
Table 6-8. Summary of Chloramine Disinfection .....	6-29
Figure 6-1. Theoretical Breakpoint Curve .....	6-2
Figure 6-2. Distribution Diagram for Chloramine Species with pH.....	6-3
Figure 6-3. Gaseous Chlorine Feed System .....	6-5
Figure 6-4. Hypochlorite Feed System .....	6-6
Figure 6-5. Anhydrous Ammonia Direct Feed System.....	6-7
Figure 6-6. Anhydrous Ammonia Solution Feed System .....	6-8
Figure 6-7. Aqua Ammonia Feed System.....	6-9

# 7. PEROXONE (OZONE/HYDROGEN PEROXIDE)

---

Advanced oxidation processes generate highly reactive hydroxyl free radicals to oxidize various compounds in the water. As discussed in Chapter 3, hydroxyl radicals are produced during the spontaneous decomposition of ozone. By accelerating the ozone decomposition rate, the hydroxyl radical concentration is elevated, which increases the oxidation rate. This procedure increases the contribution of indirect oxidation over direct ozone oxidation as discussed in Chapter 3.

Several methods have been used to increase ozone decomposition and produce high concentrations of hydroxyl radicals. One of the most common of these processes involves adding hydrogen peroxide to ozonated water, a process commonly referred to as peroxone.

The Metropolitan Water District of Southern California (MWDSC) conducted extensive research into the use of peroxone to control organics and oxidize taste and odor compounds (e.g., geosmin and 2-methylisoborneol [MIB]) while providing sufficient levels of molecular ozone to guarantee CT values and primary disinfection. While this chapter focuses on peroxone as a disinfectant, similar results are expected from other advanced oxidation processes such as ozone plus UV, ozone at high pH, hydrogen peroxide plus UV, and other combinations.

A key issue with the use of peroxone as a disinfection process is that the process does not provide a measurable disinfectant residual. It is therefore not possible to calculate CT similar to the use of other disinfectants. While no credit can be given for hydroxyl free radicals because it cannot be measured directly, some credit may be considered for any detected ozone in peroxone systems. Peroxone does provide pathogen inactivation, as discussed in this chapter, but equivalent CT values or methods of calculating equipment CT credits have not been established at the date of publication of this guidance document.

## 7.1 Peroxone Chemistry

The ozone decomposition cycle is similar to that discussed in Chapter 3. However, the added hydrogen peroxide or ultraviolet radiation accelerates the decomposition of ozone and increases the hydroxyl radical concentration. By adding hydrogen peroxide, the net production of hydroxyl free radicals is 1.0 mole hydroxyl radical per mole ozone.

Similar to the discussion of ozone in Chapter 3, oxidation in the peroxone occurs due to two reactions (Hoigné and Bader, 1978):

- Direct oxidation of compounds by aqueous ozone ( $O_{3(aq)}$ ); and
- Oxidation of compounds by hydroxyl radicals produced by the decomposition of ozone.

The two oxidation reactions compete for substrate (i.e., compounds to oxidize). The ratio of direct oxidation with molecular ozone is relatively slow ( $10^{-5}$ - $10^7 M^{-1} sec^{-1}$ ) compared to hydroxyl radical oxidation ( $10^{12}$ - $10^{14} M^{-1} sec^{-1}$ ), but the concentration of ozone is relatively high. On the other hand, the hydroxyl radical reactions are very fast, but the concentration of hydroxyl radicals under normal ozonation conditions is relatively small.

A key difference between the ozone and peroxone processes is that the ozone process relies heavily on the direct oxidation of aqueous ozone while peroxone relies primarily on oxidation with hydroxyl radical. In the peroxone process, the ozone residual is short lived because the added peroxide greatly accelerates the ozone decomposition. However, the increased oxidation achieved by the hydroxyl radical greatly outweighs the reduction in direct ozone oxidation because the hydroxyl radical is much more reactive. The net result is that oxidation is more reactive and much faster in the peroxone process compared to the ozone molecular process. However, because an ozone residual is required for determining disinfection CT credit, peroxone may not be appropriate as a pre-disinfectant.

The peroxone process utilizes oxidation by hydroxyl radicals. The oxidation potential of the hydroxyl radical and ozone are as follows:



In addition to having an oxidation potential of hydroxyl radical higher than ozone, the hydroxyl radical is also much more reactive approaching the diffusion control rates for solutes such as aromatic hydrocarbons, unsaturated compounds, aliphatic alcohols, and formic acid (Hoigné and Bader, 1976).

### 7.1.1 Oxidation Reactions

Because the radical oxidation is much more effective than direct oxidation with ozone, it has been used extensively to treat difficult to oxidize organics such as taste and odor compounds and chlorinated organics (e.g., geosmin, MIB, phenolic compounds, trichloroethylene [TCE], and perchloroethylene [PCE]).

Neither ozone nor peroxone significantly destroys TOC. Peroxone will oxidize the saturated organics and produce byproducts similar to those found in ozonation; namely, aldehydes, ketones, peroxides, bromate ion, and biodegradable organics (MWDSC and JMM, 1992). However, with peroxone, the

biodegradability of the water (not the organic compounds) increases, rendering “a portion of the TOC” amenable to removal in biologically active filters.

Peroxone has found a niche in oxidizing difficult-to-treat organics, such as taste and odor compounds including geosmin and MIB (Pereira et al., 1996; Ferguson et al., 1990). In addition, peroxone and other advanced oxidation processes have been shown to be effective in oxidizing halogenated compounds such as 1,1-dichloropropene, trichloroethylene, 1-chloropentane, and 1,2-dichloroethane (Masten and Hoigné, 1992; Aieta et al., 1988; Glaze and Kang, 1988). Hydroxyl radicals will react with all these compounds plus refractory aliphatics such as alcohols and short-chain acids (Chutny and Kucera, 1974).

The optimum peroxide:ozone dose ratio to maximize hydroxyl radicals' reaction rate can be determined for a specific oxidation application. For instance, the optimum peroxide:ozone dose ratio for TCE and PCE oxidation in a ground water was determined to be 0.5 by weight (Glaze and Kang, 1988). Tests showed that TCE required lower ozone dosages for the same percentage removal compared to PCE.

LADWP conducted pilot studies and operated a 2,000 gpm full scale AOP demonstration plant in 1995. The peroxide:ozone dose ratio used was 0.5 to 0.6. Ground water containing up to 447 mg/L TCE and 163 mg/L PCE was treated to below the respective MCLs. However, bromate ion was formed in excess of the 0.010 mg/L MCL (Karimi et al., 1997).

### **7.1.2 Reactions with Other Water Quality Parameters**

As with ozone alone, pH and bicarbonate alkalinity play a major role in peroxone effectiveness (Glaze and Kang, 1988). This role is primarily related to bicarbonate and carbonate competition for hydroxyl radical at high alkalinity and carbonate competition for hydroxyl radical at high pH levels. Also, excessive peroxide can also limit the formation of the hydroxyl radical and reduce the effectiveness of peroxone.

Turbidity alone does not appear to play a role in peroxone effectiveness nor does peroxone appear to remove turbidity. Tobiason et al. (1992) studied the impact of pre-oxidation on filtration and concluded that the pre-oxidation did not improve effluent turbidities, but did appear to increase filter run times because of lower head loss or delayed turbidity breakthrough. Filter effluent turbidities were similar for no-oxidant and pre-oxidant trains.

### **7.1.3 Comparison between Ozone and Peroxone**

The key difference between ozone and peroxone is in the primary oxidation mode; that is, direct oxidation or hydroxyl radical oxidation. The reactivities of these compounds create a different effect in the reactions with water constituents and, thus, disinfection effectiveness. Table 7-1 summarizes the

key differences between ozone and peroxone as they relate to their application in drinking water treatment.

**Table 7-1. Comparison between Ozone and Peroxone Oxidation**

Process	Ozone	Peroxone
Ozone decomposition rate	“Normal” decomposition producing hydroxyl radical as an intermediate product	Accelerated ozone decomposition increases the hydroxyl radical concentration above that of ozone alone.
Ozone residual	5-10 minutes	Very short lived due to rapid reaction.
Oxidation path	Usually direct aqueous molecular ozone oxidation	Primarily hydroxyl radical oxidation.
Ability to oxidize iron and manganese	Excellent	Less effective.
Ability to oxidize taste and odor compounds	Variable	Good, hydroxyl radical more reactive than ozone.
Ability to oxidize chlorinated organics	Poor	Good, hydroxyl radical more reactive than ozone.
Disinfection ability	Excellent	Good, but systems can only receive CT credit if they have a measurable ozone residual.
Ability to detect residual for disinfection monitoring	Good	Poor. Cannot calculate CT value for disinfection credit.

## 7.2 Generation

The peroxone process requires an ozone generation system as described in Chapter 3 and a hydrogen peroxide feed system. The process involves two essential steps: ozone dissolution and hydrogen peroxide addition. Hydrogen peroxide can be added after ozone (thus allowing ozone oxidation and disinfection to occur first) or before ozone (i.e., using peroxide as a pre-oxidant, followed by hydroxyl radical reactions) or simultaneously. Addition of hydrogen peroxide following ozone is the best way to operate, however a system cannot obtain a CT credit unless the ozone residual is sufficiently high.

There are two major effects from the coupling of ozone with hydrogen peroxide (Duguet et al., 1985):

- Oxidation efficiency is increased by conversion of ozone molecules to hydroxyl radicals; and
- Ozone transfer from the gas phase to the liquid is improved due to an increase in ozone reaction rates.

The most efficient operation is to add ozone first to obtain CT disinfection credit, followed by peroxide for hydroxyl radical oxidation.

Ozonation can be described as occurring in two stages. In the first stage, ozone rapidly destroys the initial oxidant demand present, thereby enhancing the ozone transfer rate into solution from the gas phase. Addition of hydroxyl free radicals to the first stage should be minimized since the hydrogen peroxide competes with ozone-reactive molecules (i.e., initial demand) for the ozone present. In the second stage, organic matter is oxidized, taking place much slower than in the first stage. Adding hydrogen peroxide during the second stage makes it possible to raise the overall oxidation efficiency, since the reaction of hydrogen peroxide with ozone produces hydroxyl radicals enhancing chemical reaction rates. In practice, the addition of hydrogen peroxide to the second stage of ozonation can be achieved by injecting the hydrogen peroxide into the second chamber of an ozone contactor (Duguet et al., 1985). The most efficient operation is to use ozone first to obtain CT credit and peroxone second for micropollutant destruction.

Energy consumption of the peroxone process includes that for ozone generation and application, plus for metering pumps to feed peroxide. The peroxide addition step does not require any more training from an operator than any other liquid chemical feed system. Systems should be checked daily for proper operation and for leaks. Storage volumes should also be checked daily to ensure sufficient peroxide is on hand, and to monitor usage.

## 7.3 Primary Uses and Points of Application

Peroxone is used for oxidation of taste and odor compounds, and oxidation of synthetic organic compounds. Peroxone is also used for the destruction of herbicides (e.g., atrazine), pesticides, and VOCs. Peroxone is applied at points similar to ozone for oxidation. Addition of ozone first and hydrogen peroxide second is the better way to operate. Alternatively, hydrogen peroxide can be added upstream of ozone.

### 7.3.1 Primary Uses

#### 7.3.1.1 *Taste and Odor Compound Oxidation*

Peroxone is used to remove taste and odor causing compounds because many of these compounds are very resistant to oxidation, even ozone-oxidation. More recently, significant attention has been given to tastes and odors from specific compounds such as geosmin, 2-methylisborneol (MIB), and chlorinated compounds. Studies at MWDSC demonstrated the effectiveness of peroxone to remove geosmin and MIB during water treatment (Ferguson et al., 1990; Ferguson et al., 1991; Huck et al., 1995).

#### 7.3.1.2 *Synthetic Organic Compound Oxidation*

Peroxone and other advanced oxidation processes have been shown to be effective in oxidizing halogenated compounds such as 1,1-dichloropropene (DCPE), TCE, 1-chloropentane (CPA), and 1,2-

dichloroethane (DCA) (Masten and Hoigné, 1992; Aieta et al., 1988; Glaze and Kang, 1988). The hydroxyl radicals formed react with all these compounds plus refractory aliphatics, such as alcohols and short-chain acids (Chutny and Kucera, 1974).

### 7.3.2 Points of Application

The peroxone process is applied at points similar to ozone for oxidation as discussed in Chapter 3. Importantly, peroxone addition should be after settling and prior to biological filtration. It is important to add hydrogen peroxide after the initial ozone demand is consumed to avoid hydroxyl free radical competition with the initial ozone demanding constituents.

#### 7.3.2.1 Impact on Other Treatment Processes

Peroxide addition impacts other processes at the water treatment facility. These impacts include:

- The use of hydroxyl free radicals generates BDOC, which can cause biological growth in distribution systems if not reduced during biologically active filtration. When peroxide addition is placed before filters, it impacts the filters by increasing biological growths and increasing backwash frequency (depending on the level of BDOC produced).
- Hydroxyl free radicals are strong oxidants that interfere with addition of other oxidants, such as chlorine, until the ozone residual is quenched.
- The oxidation of iron and manganese by hydroxyl free radicals generates insoluble oxides that should be removed by sedimentation or filtration. This also may impact the filters by increasing the load on the filters and increasing backwash frequency.

The reader is referred to the *Microbial and Disinfection Byproduct Simultaneous Compliance Guidance Document* (currently in production) for additional information regarding the interaction between oxidants and other treatment processes.

## 7.4 Pathogen Inactivation

Both peroxone and other advanced oxidation processes have been proven to be equal or more effective than ozone for pathogen inactivation. Disinfection credits are typically described in terms of CT requirements. Because peroxone leaves no measurable, sustainable residual, calculation of an equivalent CT for disinfection credit is not possible unless there is measurable ozone residual.

### 7.4.1 Inactivation Mechanism

Experiments have indicated that long contact times and high concentrations of hydrogen peroxide are required for bacteria and virus inactivation (Lund, 1963; Yoshe-Purer and Eylan, 1968; Mentel and Schmidt, 1973). Achieving a 99 percent inactivation of poliovirus required either a hydrogen peroxide dose of 3,000 mg/L for 360 minutes or 15,000 mg/L for 24 minutes. Based on these results, when the combination of ozone and hydrogen peroxide is used, the primary cause for pathogen inactivation is

attributed to ozone, specifically the mechanisms associated with the oxidation of pathogens by direct ozone reaction and hydroxyl radicals.

As described in Chapter 3, the mode of action of ozone on microorganisms is poorly understood. Some studies on bacteria suggest that ozone alters proteins and unsaturated bonds of fatty acids in the cell membrane, leading to cell lysis (Scott and Leshner, 1963; Pryor et al., 1983), while other studies suggest that ozone may affect deoxyribonucleic acid (DNA) in the cell (Hamelin and Chung, 1974; Ohlrogge and Kernan, 1983; Ishizaki et al., 1987). Virus inactivation was reported to be related to the attack of the protein capsid by ozone (Riesser et al., 1977). Little information was found discussing the mode of action of ozone on protozoan oocysts. However, a few researchers have suggested that ozone causes the oocyst density to decrease and alters the oocyst structure (Wickramanayake, 1984; Wallis et al., 1990).

The debate continues regarding the primary mode of action for hydroxyl free radicals. Some researchers believe that ozone disinfection is a result of direct ozone reaction (Hoigné and Bader, 1975; Hoigné and Bader, 1978), while others believe that the hydroxyl radical mechanism for disinfection is the most important mechanism (Dahi, 1976; Bancroft et al., 1984). Studies using ozone-hydrogen peroxide have shown that disinfection of *E. coli* is less effective as the peroxide to ozone ratio increases to above approximately 0.2 mg/mg (Wolfe et al., 1989a; Wolfe et al., 1989b). The decrease in disinfection was believed to be caused by lower ozone residuals associated with higher peroxide to ozone ratios, which indicates that direct ozone reaction is an important mechanism for pathogen inactivation.

## 7.4.2 Environmental Effects

Although the chemistry of the peroxone process is still not completely understood, optimal production of the hydroxyl radical appears to depend on the pH, ozone concentration, ratio of hydrogen peroxide to ozone, contact time, and water composition (Glaze et al., 1987).

### 7.4.2.1 Competing Chemical Reactions

One disadvantage of the peroxone process is that it involves radical intermediates that are subject to interference from substances that react with hydroxyl radical, decreasing the effectiveness of the process. Alkalinity, bicarbonate, and pH play a major role in the effectiveness of hydroxyl free radicals. This effect is primarily related to bicarbonate competition for hydroxyl radical at high alkalinity and carbonate competition for hydroxyl radical at pH levels higher than 10.3 (see Chapter 3). Lowering the alkalinity prior to the application of the peroxone process may be necessary for water that has a high bicarbonate level. In addition to carbonate and bicarbonate, organic constituents of humic substances have also been found to react with the hydroxide radical (Glaze, 1986).

### 7.4.2.2 Ratio of Hydrogen Peroxide and Ozone

A study conducted at MWDSC indicated that the performance of peroxone is greatly dependent upon the peroxide:ozone ratio (Wolfe et al., 1989b). Results from previous studies at MWDSC suggested that the optimal ratio for disinfection was less than or equal to 0.3. One of the primary objectives of the 1989 study was to optimize further the process for disinfection by altering peroxide:ozone ratios and contact times. Results from the study indicated that peroxone at a 0.2 ratio of peroxide:ozone was comparable to ozone for disinfection of indicator organisms and *Giardia muris* cysts, and that at higher ratios, disinfection decreased because ozone decreased.

### 7.4.3 Disinfection Efficacy and Pathogen Inactivation

Recent studies have indicated that the disinfection effectiveness of peroxone and ozone are comparable (Wolfe et al., 1989b; Ferguson et al., 1990; Scott et al., 1992). A study conducted by Ferguson et al. (1990) compared the pathogen inactivation capability of peroxone and ozone using MS-2 and f2 coliphages as well as *E. coli*. and heterotrophic plate count (HPC) bacteria. The f2 and MS-2 coliphages were comparable in their resistance to ozone and peroxone. No differences in the amounts of MS-2 or f2 inactivation were apparent when the peroxide:ozone ratio was varied from 0 to 0.3. Results of the *E. coli*. and HPC studies showed that peroxone and ozone also had comparable results in regards to bacteria inactivation.

Table 7-2 lists CT values derived for inactivation of *Giardia muris* cysts by ozone and peroxone from another study conducted by MWDSC. The contact times used for calculating the CT values were based on 10% and 50% breakthrough of tracer compounds in the contactor. Ozone concentrations used for CT were based on the ozone residual and half of the residual and dose. The results of this study suggest that peroxone is slightly more potent than ozone based on the fact that CT values for ozone were greater than for peroxone. However, because ozone decomposes more rapidly in the presence of hydrogen peroxide, higher ozone dosages may be necessary with peroxone to achieve comparable residuals. Moreover, the use of ozone residuals to calculate CT products for peroxone may not take into account other oxidizing species that may have disinfectant capabilities.

**Table 7-2. Calculated CT Values (mg•min/L) for the Inactivation of *Giardia muris***

Inactivation	Ozone C <sub>1</sub> T <sub>1</sub> <sup>a</sup>	Ozone C <sub>2</sub> T <sub>2</sub> <sup>a</sup>	Peroxone <sup>b</sup> C <sub>1</sub> T <sub>1</sub> <sup>a</sup>	Peroxone C <sub>2</sub> T <sub>2</sub> <sup>a</sup>
90%	1.6	2.8	1.2	2.6
99%	3.4	5.4	2.6	5.2

Data obtained from Wolfe et al., 1989b. Results at 14°C.

<sup>a</sup> C<sub>1</sub>, ozone residual; C<sub>2</sub> (ozone dose + ozone residual)/2; T<sub>1</sub> and T<sub>2</sub> time (in minutes) to reach 10 percent and 50 percent breakthrough, respectively

<sup>b</sup> The H<sub>2</sub>O<sub>2</sub>/O<sub>3</sub> ratio for all results was 0.2.

## 7.5 Disinfection Byproducts

The principal byproducts associated with peroxone are expected to be similar to those for ozonation and are listed in Table 3-9. Additional DBPs could form from reactions with hydroxyl radicals. Peroxone does not form halogenated DBPs when participating in oxidation/reduction reactions with NOM. However, if bromide ion is present in raw water halogenated DBPs may be formed. Similar to ozone, the principal benefit of using peroxone for controlling THM formation appears to be that it eliminates the need for pre-chlorination and allows lower doses of free chlorine or chloramines to be applied later in the process train after precursors have been removed by coagulation, sedimentation, and/or filtration and at lower doses. But peroxone does not reduce the DBPFP.

Based upon studies and findings involving peroxone, there is no beneficial lowering of THMs as long as free chlorine is utilized as a secondary disinfectant, unless the application of peroxone allows chlorine to be applied later in the process train to water containing reduced precursor concentrations. The MWDSC study found that the use of peroxone/chlorine resulted in THM concentrations 10 to 38 percent greater than the use of ozone/chlorine. However, the THM concentrations of waters disinfected with peroxone/chloramines and ozone/chloramines were similar (Ferguson et al., 1990).

The use of peroxone as a primary disinfectant and chloramines as a secondary disinfectant can successfully control halogenated DBP formation if bromide ion is not present and adequate CT credit can be established. As with ozone, bromate ion formation is a potential concern with source waters containing bromide ions. The oxidation reaction of bromide ion ( $\text{Br}^-$ ) to hypobromite ion ( $\text{BrO}^-$ ) and bromite ion ( $\text{BrO}_2^-$ ) and subsequently to bromate ion ( $\text{BrO}_3^-$ ) occurs due to direct reaction with ozone, intermediate reactions can also occur through hydroxide radical mediated mechanisms if bromide is not present and adequate CT credit can be established (Pereira et al., 1996).

In general, peroxone produces more bromate ion than ozone when similar ozone residuals (CT credits) are achieved (Krasner et al., 1993). On the other hand, when the ozone dosage is kept constant, peroxone has tended to produce comparable amounts of bromate ion as ozone. Although peroxone produces hydroxyl radicals that can increase bromate ion formation, hydrogen peroxide may also reduce the hypobromite ion (produced initially during the ozonation of bromide) back to bromide ion.

A study by MWDSC evaluated the effectiveness of peroxone to control taste and odor, DBPs, and microorganisms (Ferguson et al., 1990). In attempting to optimize the hydrogen peroxide to ozone ratio ( $\text{H}_2\text{O}_2:\text{O}_3$ ) and the contact time for the source water, the study found pre-oxidation of source waters followed by secondary disinfection with chloramines was an effective strategy for controlling concentrations of THMs and other DBPs. The study found that the two source waters disinfected with peroxone, with free chlorine as the secondary disinfectant, resulted in THM concentrations ranging from 67 to 160  $\mu\text{g}/\text{L}$ . Conversely, using chloramines as a secondary disinfectant resulted in THM concentrations consistently below 3.5  $\mu\text{g}/\text{L}$  (Ferguson et al., 1990).

However, if a short free chlorine contact time is applied after biological filtration and before ammonia addition to inactivate heterotrophic plate count bacteria in the effluent of the biologically active filter—THMs and other DBPs will be formed at higher concentrations than from post chloramination alone. Depending on the TOC and bromide ion concentration of the water, as well as the pH of chlorination, temperature, and reaction time, between 2 and 28 µg/L of TTHMs have been formed in experiments conducted at MWDSC (personal communication, 1998).

Bromate formation in conventional ozonation, and advanced oxidation processes combining ozone and hydrogen peroxide, were recently investigated at five water treatment plants in France. The source water bromide ion concentrations ranged from 35 to 130 µg/L. Bromate ion formation during the ozonation step varied from less than 2 to 42 µg/L. In general, advanced oxidation results in greater bromate ion concentrations when compared with conventional ozonation, provided the same ozone residual is maintained for both processes. However, lower concentrations of bromate ion result if the ozone dosage is kept constant between the two processes and the hydrogen peroxide dosage is increased (von Gunten et al., 1996). To reduce bromate ion formation potential, the proposed ozone contactor at Stone Canyon Filtration Plant includes three ozone application points instead of two (Stolarik and Christie, 1997). Thus, when peroxone is used for obtaining CT credit, more bromate ion may form than during ozonation. However, if peroxone is only used for micropollutant destruction, less bromate ion may form than when ozone is used.

## 7.6 Status of Analytical Methods

Hydrogen peroxide in solution reacts with ozone to ultimately form water and oxygen. Consequently, the simultaneous presence of both oxidants is accepted as being only transient (Masschelein et al., 1977). Chapter 3 summarizes ozone analytical methods that can be used for ozone/hydrogen peroxide disinfectant residual monitoring. This section will present the status of analytical methods for hydrogen peroxide only.

### 7.6.1 Monitoring of Hydrogen Peroxide

Standard Methods (1995) does not list procedures for measuring hydrogen peroxide. Gordon et al. (1992) list several methods for hydrogen peroxide analysis including:

- Titration methods;
- Colorimetric methods; and
- Horseradish peroxidase methods.

Table 7-3 shows the working range, expected accuracy and precision, operator skill level required, interferences and current status for hydrogen peroxide analysis.

### **7.6.1.1 Titration Methods**

Two titration methods are available for the analysis of hydrogen peroxide; namely, iodometric and permanganate. Precautions for the iodometric titration include the volatility of iodine, interferences by metals such as iron, copper, nickel, and chromium, and fading titration end points (Gordon et al., 1992). Organic and inorganic substances that react with permanganate will interfere with the permanganate titration.

Titration of hydrogen peroxide with permanganate or iodide ion is not sufficiently sensitive for determining residual concentrations (Masschelein et al., 1977).

### **7.6.1.2 Colorimetric Methods**

The most widespread method for the colorimetric determination of hydrogen peroxide is that based on the oxidation of a Titanium (IV) salt (Masschelein et al., 1977). A yellow complex is formed and measured by absorption at 410 nm. On a qualitative basis, ozone and persulfates do not produce the same colored complex.

The oxidation of the leuco base of phenolphthalein is used as a qualitative test for hydrogen peroxide (Dukes and Hydier, 1964). Sensitivity and precision of the method is sufficient in the range between 5 and 100  $\mu\text{g/L}$ . This low working analytical range makes this method impractical for measuring hydrogen peroxide residual levels. Also, the instability of the color obtained makes the method less suitable for manual use. No interference data are available, but it is expected that other oxidants would interfere (Gordon et al., 1992).

The oxidation of cobalt (II) and bicarbonate in the presence of hydrogen peroxide produces a carbonato-cobaltate (III) complex (Masschelein et al., 1977). This complex has absorption bands at 260, 440, and 635 nm. The 260 nm band has been used for the measurement of hydrogen peroxide. A detection limit of 0.01 mg/L has been reported (Masschelein et al., 1977). Optical interferences are caused by 100 mg/L nitrate and 1 mg/L chlorite ions. Other oxidizing agents do interfere with this method as will any compound with an absorption at 260 nm (Gordon et al., 1992).

**Table 7-3. Characteristics and Comparisons of Hydrogen Peroxide Analytical Methods**

Type of Test	Working Range (mg/L)	Expected Accuracy (± percent)	Expected Precision (± percent)	Skill Level <sup>a</sup>	Interferences	pH Range	Field Test	Automated Test	Current Status
Iodometric Titration	> 10	5	5	2	Oxidizing Species	Acidic	Yes	No	Currently Used
Permanganate Titration	0.1 - 100	5	5	2	Oxidizing Species	Acidic	Yes	No	Currently Used
Colorimetry, Titanium IV	0.1 - 5	NR	NR	2	Ozone	Acidic	Yes	No	Not Recommended
Colorimetry, Leuco Base of Phenolphthalein	0.005 - 0.1	NR	NR	2	Ozone	Neutral	Yes	Yes	Not Recommended
Colorimetry, Cobalt III/HCO <sub>3</sub> <sup>-</sup>	0.01 - 1	NR	NR	2	Ozone	Neutral	Yes	Yes	Not Recommended
HRP <sup>b</sup>	10 <sup>-8</sup> - 10 <sup>-5</sup>	NR	NR	2	Other Peroxides, Ozone	4.5 - 5.5	No	Yes	Currently Used

## Notes:

<sup>a</sup> Operator Skill Levels: 1 = minimal, 2 = good technician, 3 = experienced chemist

NR = Not reported in literature cited by referenced source.

Adapted from Gordon et al., 1992

<sup>b</sup> This method can not be used in real peroxone-treated waters where the hydrogen peroxide concentration is significantly higher.

### **7.6.1.3 Horseradish Peroxidase Methods**

Several methods incorporate the chemical reactions between peroxidase and hydrogen peroxide. Horseradish derived peroxidase (HRP) is used most often. The scopoletin procedure is one of the more widely accepted fluorescent methods of low levels of hydrogen peroxide utilizing HRP (Gordon et al., 1992). Again, no information is available on potential interference.

### **7.6.1.4 Summary**

In general, the analytical procedures for hydrogen peroxide in drinking water are impacted by other oxidizing species such as ozone. Three of the methods are currently used, but not recommended for disinfectant residual measurement (Table 7-3). The scopoletin HRP method is the most promising, although additional study of potential interferences is required (Gordon et al., 1992).

## **7.7 Operational Considerations**

Peroxide is a strong oxidant and contact with personnel should be avoided. Secondary containment should be provided for storage tanks to contain any spills. Dual containment piping should be considered to minimize the risk of exposure to plant personnel. Storage containers may explode in the presence of extreme heat or fire.

### **7.7.1 Process Considerations**

The impacts of the peroxone process are similar to those described for ozone in Chapter 3. Because an additional oxidant is added to the water, the tendency to transform organic carbon compounds to a more biodegradable form may be increased with the addition of peroxide.

### **7.7.2 Space Requirements**

The metering pumps used to add peroxide should be housed with adequate space around each pump for maintenance access. These pumps are generally not very large, so space requirements are not significant.

The storage area can range from small where peroxide is obtained in drums, to large tank farms if plant flow is great. As mentioned previously, secondary containment should be provided. Peroxide has a lower freezing point than water. Housing or heat tracing should be provided for storage tanks and exterior piping if extended periods with temperatures below freezing are anticipated.

### **7.7.3 Materials**

Peroxide can be stored in polyethylene drums or tanks. The specific gravity is 1.39 for 50 percent peroxide, which should be considered in the design of the tank walls. Acceptable pipe materials for peroxide include 316 stainless steel, polyethylene, CPVC, and Teflon. Gaskets should be Teflon

because natural rubber, Hypalon and EPDM are not resistant to hydrogen peroxide. Metering pumps heads should be constructed of peroxide resistant materials.

Hydrogen peroxide is purchased from chemical suppliers and is commercially available in 35, 50, and 75 percent strengths. Peroxide is supplied in drums or in bulk by tankcar. Price depends on strength and quantity.

Peroxide can be stored onsite, but deteriorates gradually over time even when stored correctly. Peroxide deteriorates rapidly if contaminated and with heat or exposure to certain materials. Peroxide is added to the water with metering pumps to accurately control dose. Pumps should be designed to prevent potential air binding of peroxide off-gas. Multiple pumps should be provided for redundancy. As with any chemical added to water, adequate mixing should be provided.

## 7.8 Summary

### 7.8.1 Advantages and Disadvantages of Peroxone Use (Ozone/Hydrogen Peroxide)

The following list highlights selected advantages and disadvantages of using peroxone as a disinfection method for drinking water. Because of the wide variation of system size, water quality, and dosages applied, some of these advantages and disadvantages may not apply to a particular system.

#### Advantages

- Oxidation is more reactive and much faster in the peroxone process compared to the ozone molecular process.
- Peroxone is effective in oxidizing difficult-to-treat organics, such as taste and odor compounds.
- Peroxone processes have been shown to be effective in oxidizing halogenated compounds.
- The tendency to transform organic carbon compounds to a more biodegradable form may be increased with the addition of peroxide.
- Pumps used to house peroxide are not very large; so space requirements are not significant.

#### Disadvantages

- Peroxide is a strong oxidant and contact with personnel is extremely dangerous.
- Peroxide can be stored onsite, but deteriorates gradually even when stored correctly.

- Peroxone as a disinfection process does not provide a measurable disinfectant residual. It is therefore not possible to calculate CT similar to the use of other disinfectants.
- Peroxone's ability to oxidize iron and manganese is less effective than that of ozone.

## 7.8.2 Summary Table

Table 7-4 summarizes the considerations relative to peroxone disinfection considerations.

**Table 7-4. Summary of Peroxone Disinfection Consideration**

Consideration	Description
Generation	Because of its instability, ozone must be generated at the point-of-use. Hydrogen peroxide is purchased from chemical suppliers. Hydrogen peroxide can be stored onsite, but is subject to deterioration.
Primary uses	Primary use includes chemical oxidation. As an oxidizing agent, peroxone can be used to remove SOC pollutants and increase the biodegradability of organic compounds. Peroxone is an effective disinfectant but its CT credit has not been established. It is highly reactive and does not maintain an appreciable residual for CT credit calculations. Peroxone may be difficult to use for disinfection because it is highly reactive and does not maintain an appreciable ozone residual level.
Inactivation efficiency	Peroxone is one of the most potent and effective germicides used in water treatment. It is slightly more effective than ozone against bacteria, viruses, and protozoan cysts.
Byproduct formation	Peroxone itself does not form halogenated DBPs; however, if bromide is present in the raw water or if chlorine is added as a secondary disinfectant, halogenated DBPs including bromate may be formed. Other byproducts include organic acids and aldehydes.
Limitations	Ideally, ozone should be used as a primary disinfectant prior to peroxone treatment.
Point of application	For disinfection, peroxone addition should be after ozonation. Ozone contact should precede addition of hydrogen peroxide. For oxidation, peroxone can be added prior to coagulation/sedimentation or filtration depending on the constituents to be oxidized.
Special considerations	Ozone generation is a relatively complex process. Storage of LOX for ozone generation is subject to building and fire codes. Ozone is a highly toxic gas and the ozone production and application facilities must be monitored for ambient ozone. Hydrogen peroxide is a hazardous material requiring secondary containment for storage facilities.

## 7.9 References

1. Aieta, E.M., K.M. Reagan, J.S. Lang, L. McReynolds, J-W Kang, and W.H. Glaze. 1988. "Advanced Oxidation Processes for Treating Groundwater Contaminated with TCE and PCE: Pilot-Scale Evaluations." *J. AWWA*. 88(5): 64-72.
2. Bancroft, K.P., et al. 1984. "Ozonation and Oxidation Competition Values." *Water Res.* 18:473.
3. Chutny, B. and J. Kucera. 1974. "High Energy Radiation-induced Synthesis of Organic Compounds. I. Introduction Isomerization and Carbon-Skeleton Changes, Radiation Synthesis in Aqueous Solutions." *Rad. Res. Rev.* 5:1-54.
4. Dahi, E. 1976. "Physicochemical Aspects of Disinfection of Water by Means of Ultrasound and Ozone." *Water Res.* 10:677.
5. Duguet, J., E. Brodard, B. Dussert, and J. Malevialle. 1985. "Improvement in the Effectiveness of Ozonation of Drinking Water Through the Use of Hydrogen Peroxide." *Ozone Sci. Engrg.* 7(3):241-258.
6. Dukes, E.K., and M.L. Hydiar. 1964. "Determination Of Peroxide By Automated Chemistry." *Anal. Chem.* 36:1689-1690.
7. Ferguson, D.W., J.T. Gramith, and M.J. McGuire. 1991. "Applying Ozone for Organics Control and Disinfection: A Utility Perspective." *J. AWWA*. 83(5):32-39.
8. Ferguson, D.W., M.J. McGuire, B. Koch, R.L. Wolfe, and E.M. Aieta. 1990. "Comparing Peroxone an Ozone for Controlling Taste and Odor Compounds, Disinfection Byproducts, and Microorganisms." *J. AWWA*. 82(4):181.
9. Glaze, W. H., et al. 1987. "The Chemistry of Water Treatment Processes Involving Ozone, Hydrogen Peroxide, and Ultraviolet Radiation." *Ozone: Sci. Engrg.* 9(4):335.
10. Glaze, W.H. 1986. "Reaction Products of Ozone: A Review." *Environ. Health Perspectives*, 69:151-157.
11. Glaze, W.H., and J-W Kang. 1988. "Advanced Oxidation Processes for Treating Groundwater Contaminated With TCE and PCE: Laboratory Studies." *J. AWWA*. 88(5): 57-63.
12. Gordon, G., Cooper, W.J., Rice, R.G., and Pacey, G.E. 1992. *Disinfectant Residual Measurement Methods*. Second Edition. AWWARF and AWWA, Denver, CO.
13. Hamelin, C. and Y.S. Chung. 1974. "Optimal Conditions for Mutagenesis by Ozone in *Escherichia coli* K12." *Mutation Res.* 24:271.

14. Hoigné, J. and H. Bader. 1975. "Ozonation of Water: Role of Hydroxyl Radicals as Oxidizing Intermediates." *Science*. 190(4216):782.
15. Hoigné J. and H. Bader. 1978. "Ozone Initiated Oxidations of Solutes in Wastewater: A Reaction Kinetic Approach." *Progress Water Technol.* 10(516):657.
16. Hoigné J. and Bader. 1976. "The Role of Hydroxyl Radical Reacting in Ozonation Processes in Aqueous Solutions." *Water Resources*. 10:377.
17. Huck, P.M., Anderson, W.B. Lang, C.L. Anderson, W.A. Fraser, J.C. Jasim, S.Y. Andrews, S.A. and Pereira, G. 1995. Ozone vs. Peroxone for Geosmin and 2-Methylisoborneol Control: Laboratory, Pilot and Modeling Studies. Conference proceedings, AWWA Annual Conference, Anaheim, CA.
18. Ishizaki, K. et al. 1987. "Effect of Ozone on Plasmid DNA of *Escherichia coli* In Situ." *Water Res.* 21(7):823.
19. Karimi, A.A., J.A. Redman, W.H. Glaze, and G.F. Stolarik. 1997. "Evaluation an AOP for TCE and PCE Removal." *J. AWWA*. 89(8):41-53.
20. Krasner, S.W., W.H. Glaze, H.S. Weinberg, P.A. Daniel, and I.N. Najm. 1993. "Formation and Control of Bromate During Ozonation of Waters Containing Bromide." *J. AWWA*. 85(1):73-81.
21. Lund, E. 1963. "Significance of Oxidation in Chemical Inactivation of Poliovirus." *Arch. Gesamite Virusforsch.* 12:648.
22. Masschelein, W., M. Denis, and R. Ledent. 1977. "Spectrophotometric Determination Of Residual Hydrogen Peroxide." *Water Sewage Works*. 69-72.
23. Masten, S.J. and J. Hoigné. 1992. "Comparison of Ozone and Hydroxyl Radical-Induced Oxidation of Chlorinated Hydrocarbons in Water." *Ozone Sci. Engrg.* 14(3):197-214.
24. Mentel, R. and J. Schmidt. 1973. "Investigations of Rhinoviruse Inactivation by Hydrogen Peroxide." *Acta Virol.* 17:351.
25. MWDC and JMM (Metropolitan Water District of Southern California and James M. Montgomery Consulting Engineers). 1992. "Pilot Scale Evaluation of Ozone and Peroxone." AWWARF and AWWA, Denver, CO.
26. Ohlrogge, J.B. and T.P. Kernan. 1983. "Toxicity of Activated Oxygen: Lack of Dependence on Membrane Fatty Acid Composition." *Biochemical and Biophysical Research Communications*. 113(1):301.

27. Pereira, G., P.M. Huck, and W.A. Anderson. 1996. "A Simplified Kinetic Model for Predicting Peroxone Performance for Geosmin Removal in Full-Scale Processes." Conference proceedings, AWWA Water Quality Technology Conference; Part I. New Orleans, LA.
28. Pryor, W.A. M.M. Dooley, and D.F. Church. 1983. "Mechanisms for the Reaction of Ozone with Biological Molecules: The Source of the Toxic Effects of Ozone." *Advances in Modern Environmental Toxicology*. M.G. Mustafa and M.A. Mehlman (editors). Ann Arbor Science Publishers, Ann Arbor, MI.
29. Riesser, V. N., et al. 1977. "Possible Mechanisms for Poliovirus Inactivation by Ozone." *Forum on Ozone Disinfection*. E.G. Fochtman, et al. (editors). International Ozone Institute Cleveland, OH.
30. Scott, D.B.N. and E.C. Leshner. 1963. "Effect of Ozone on Survival and Permeability of *Escherichia coli*." *J. Bacteriology*. 85:567.
31. Scott, K.N., et al. 1992. "Pilot-Plant-Scale Ozone and Peroxone Disinfection of *Giardia muris* Seeded Into Surface Water Supplies." *Ozone Sci. Engrg.* 14(1):71.
32. Standard Methods. 1995. *Standard Methods for the Examination of Water and Wastewater*, nineteenth edition, Franson, M.H., Eaton, A.D., Clesceri, L.S., and Greenberg, A.E., (editors). American Public Health Association, AWWA, and Water Environment Federation, Washington D.C.
33. Stolarik, G., and J.D. Christie. 1997. "A Decade of Ozonation in Los Angeles." Conference proceedings, IOA Pan American Group Annual Conference, Lake Tahoe, NV.
34. Tobiason, J.E., J.K. Edzwald, O.D. Schneider, M.B. Fox, and H.J. Dunn. 1992. "Pilot Study of the Effects of Ozone and Peroxone on In-Line Direct Filtration." *J. AWWA*. 84(12):72-84.
35. Von Gunten, U., A. Bruchet, and E. Costentin. 1996. "Bromate Formation in Advanced Oxidation Processes." *J. AWWA*. 88(6):53.
36. Wallis, P.M. et al. 1990. "Inactivation of *Giardia* Cysts in Pilot Plant Using Chlorine Dioxide and Ozone." Conference proceedings, AWWA Water Quality Technology Conference, Philadelphia, PA.
37. Wickramanayake, G.B. 1984. *Kinetics and Mechanism of Ozone Inactivation of Protozoan Cysts*. Ph.D dissertation, Ohio State University.
38. Wolfe, R.L. et al. 1989a. "Disinfection of Model Indicator Organisms in a Drinking Water Pilot Plant by Using Peroxone." *Appl. Environ. Microbiol.* 55:2230.

39. Wolfe, R.L., et al. 1989b. "Inactivation of *Giardia muris* and Indicator Organisms Seeded in Surface Water Supplies by Peroxone and Ozone." *Environ. Sci. Technol.* 23(6):774.
40. Yoshe-Purer, Y. and E. Eylan. 1968. "Disinfection of Water by Hydrogen Peroxide." *Health Lab Sci.* 5.

THIS PAGE INTENTIONALLY LEFT BLANK

<b>7. PEROXONE (OZONE/HYDROGEN PEROXIDE)</b> .....	<b>7-1</b>
7.1 PEROXONE CHEMISTRY .....	7-1
7.1.1 Oxidation Reactions .....	7-2
7.1.2 Reactions with Other Water Quality Parameters .....	7-3
7.1.3 Comparison between Ozone and Peroxone .....	7-3
7.2 GENERATION.....	7-4
7.3 PRIMARY USES AND POINTS OF APPLICATION.....	7-5
7.3.1 Primary Uses.....	7-5
7.3.2 Points of Application.....	7-6
7.4 PATHOGEN INACTIVATION .....	7-6
7.4.1 Inactivation Mechanism .....	7-6
7.4.2 Environmental Effects.....	7-7
7.4.3 Disinfection Efficacy and Pathogen Inactivation.....	7-8
7.5 DISINFECTION BYPRODUCTS .....	7-9
7.6 STATUS OF ANALYTICAL METHODS.....	7-10
7.6.1 Monitoring of Hydrogen Peroxide .....	7-10
7.7 OPERATIONAL CONSIDERATIONS.....	7-13
7.7.1 Process Considerations.....	7-13
7.7.2 Space Requirements .....	7-13
7.7.3 Materials.....	7-13
7.8 SUMMARY.....	7-14
7.8.1 Advantages and Disadvantages of Peroxone Use (Ozone/Hydrogen Peroxide) .....	7-14
7.8.2 Summary Table .....	7-15
7.9 REFERENCES .....	7-16

Table 7-1. Comparison between Ozone and Peroxone Oxidation .....

Table 7-2. Calculated CT Values (mg•min/L) for the Inactivation of *Giardia muris* .....

Table 7-3. Characteristics and Comparisons of Hydrogen Peroxide Analytical Methods .....

Table 7-4. Summary of Peroxone Disinfection Consideration.....

# 8. ULTRAVIOLET RADIATION

---

Unlike most disinfectants, ultraviolet (UV) radiation does not inactivate microorganisms by chemical interaction. UV radiation inactivates organisms by absorption of the light which causes a photochemical reaction that alters molecular components essential to cell function. As UV rays penetrate the cell wall of the microorganism, the energy reacts with nucleic acids and other vital cell components, resulting in injury or death of the exposed cells. There is ample evidence to conclude that if sufficient dosages of UV energy reach the organisms, UV can disinfect water to whatever degree is required. However, there has been some public health concerns with respect to the overall efficiency of UV to disinfect potable water.

Based on the available research literature, it appears that although exceptional for disinfection of small microorganisms such as bacteria and viruses, UV doses required to inactivate larger protozoa such as *Giardia* and *Cryptosporidium* are several times higher than for bacteria and virus inactivation (White, 1992; DeMers and Renner, 1992). As a result, UV is often considered in concert with ozone and/or hydrogen peroxide to enhance the disinfection effectiveness of UV or for ground water where *Giardia* and *Cryptosporidium* are not expected to occur.

## 8.1 UV Chemistry (Photochemical)

### 8.1.1 UV Radiation

UV radiation quickly dissipates into water to be absorbed or reflected off material within the water. As a result, no residual is produced. This process is attractive from a DBP formation standpoint; however, a secondary chemical disinfectant is required to maintain a residual throughout the distribution system, which may be subject to recontamination.

UV radiation energy waves are the range of electromagnetic waves 100 to 400 nm long (between the X-ray and visible light spectrums). The division of UV radiation may be classified as Vacuum UV (100-200 nm), UV-C (200-280 nm), UV-B (280-315 nm) and UV-A (315-400 nm). In terms of germicidal effects, the optimum UV range is between 245 and 285 nm. UV disinfection utilizes either: low-pressure lamps that emit maximum energy output at a wavelength of 253.7 nm; medium-pressure lamps that emit energy at wavelengths from 180 to 1370 nm; or lamps that emit at other wavelengths in a high intensity “pulsed” manner.

### 8.1.2 UV Disinfection Reactions

The degree to which the destruction or inactivation of microorganisms occurs by UV radiation is directly related to the UV dose. The UV dosage is calculated as:

$$D = I \cdot t$$

Where:  $D = \text{UV Dose, mW}\cdot\text{s}/\text{cm}^2$

$I = \text{Intensity, mW}/\text{cm}^2$

$t = \text{Exposure time, s}$

Research indicates that when microorganisms are exposed to UV radiation, a constant fraction of the living population is inactivated during each progressive increment in time. This dose-response relationship for germicidal effect indicates that high intensity UV energy over a short period of time would provide the same kill as a lower intensity UV energy at a proportionally longer period of time.

The UV dose required for effective inactivation is determined by site-specific data relating to the water quality and log removal required. Based on first order kinetics, the survival of microorganisms can be calculated as a function of dose and contact time (White, 1992; USEPA, 1996). For high removals, the remaining concentration of organisms appears to be solely related to the dose and water quality, and not dependent on the initial microorganism density. Tchobanoglous (1997) suggested the following relationship between coliform survival and UV dose:

$$N = f \cdot D^n$$

Where:  $N = \text{Effluent coliform density, /100mL}$

$D = \text{UV dose, mW}\cdot\text{s}/\text{cm}^2$

$n = \text{Empirical coefficient related to dose}$

$f = \text{Empirical water quality factor}$

The empirical water quality factor reflects the presence of particles, color, etc. in the water. For water treatment, the water quality factor is expected to be a function of turbidity and transmittance (or absorbance).

### 8.1.3 Process Variables

Since UV radiation is energy in the form of electromagnetic waves, its effectiveness is not limited by chemical water quality parameters. For instance, it appears that pH, temperature, alkalinity, and total

inorganic carbon do not impact the overall effectiveness of UV disinfection (AWWA and ASCE, 1990). However, hardness may cause problems with keeping the lamp sleeves clean and functional. The presence, or addition, of oxidants (e.g., ozone and/or hydrogen peroxide) enhances UV radiation effectiveness. The presence of some dissolved or suspended matter may shield microorganisms from the UV radiation. For instance, iron, sulfites, nitrites and phenols all absorb UV light (DeMers and Renner, 1992). Accordingly, the absorbance coefficient is an indication of this demand and is unique for all waters. As a result, specific “design” parameters vary for individual waters and should be determined empirically for each application.

UV demand of water is measured by a spectrophotometer set at a wavelength of 254 nm using a 1 cm thick layer of water. The resulting measurement represents the absorption of energy per unit depth, or absorbance. Percent transmittance is a parameter commonly used to determine the suitability of UV radiation for disinfection. The percent transmittance is determined from the absorbance (A) by the equation:

$$\text{Percent Transmittance} = 100 \times 10^{-A}$$

Table 8-1 shows corresponding absorbance measurements and percent transmittance measurements for various water qualities.

**Table 8-1. Water Quality and Associated UV Measurements**

Source Water Quality	Absorbance (absorbance units/cm)	Percent Transmittance
Excellent	0.022	95%
Good	0.071	85
Fair	0.125	75

Source: DeMers and Renner, 1992.

Continuous wave UV radiation at doses and wavelengths typically employed in drinking water applications, does not significantly change the chemistry of water nor does it significantly interact with any of the chemicals within the water (USEPA, 1996). Therefore, no natural physiochemical features of the water are changed and no chemical agents are introduced into the water. In addition, UV radiation does not produce a residual. As a result, formation of THM or other DBPs with UV disinfection is minimal (See Section 8.5, *Disinfection Byproducts of UV Radiation*).

## 8.2 Generation

Producing UV radiation requires electricity to power UV lamps. The lamps typically used in UV disinfection consist of a quartz tube filled with an inert gas, such as argon, and small quantities of mercury. Ballasts control the power to the UV lamps.

## 8.2.1 UV Lamps

UV lamps operate in much the same way as fluorescent lamps. UV radiation is emitted from electron flow through ionized mercury vapor to produce UV energy in most units. The difference between the two lamps is that the fluorescent lamp bulb is coated with phosphorous, which converts the UV radiation to visible light. The UV lamp is not coated, so it transmits the UV radiation generated by the arc (White, 1992).

Both low-pressure and medium-pressure lamps are available for disinfection applications. Low-pressure lamps emit their maximum energy output at a wavelength of 253.7 nm, while medium pressure lamps emit energy with wavelengths ranging from 180 to 1370 nm. The intensity of medium-pressure lamps is much greater than low-pressure lamps. Thus, fewer medium pressure lamps are required for an equivalent dosage. For small systems, the medium pressure system may consist of a single lamp. Although both types of lamps work equally well for inactivation of organisms, low-pressure UV lamps are recommended for small systems because of the reliability associated with multiple low-pressure lamps (DeMers and Renner, 1992) as opposed to a single medium pressure lamp, and for adequate operation during cleaning cycles.

Recommended specifications for low-pressure lamps (DeMers and Renner, 1992) include:

- L-type ozone-free quartz;
- Instant start (minimal delay on startup);
- Designed to withstand vibration and shock; and
- Standard nonproprietary lamp design.

Typically, low-pressure lamps are enclosed in a quartz sleeve to separate the water from the lamp surface. This arrangement is required to maintain the lamp surface operating temperature near its optimum of 40°C. Although Teflon sleeves are an alternative to quartz sleeves, quartz sleeves absorb only 5 percent of the UV radiation, while Teflon sleeves absorb 35 percent (Combs and McGuire, 1989). Therefore, Teflon sleeves are not recommended.

## 8.2.2 Ballasts

Ballasts are transformers that control the power to the UV lamps. Ballasts should operate at temperatures below 60°C to prevent premature failure. Typically, the ballasts generate enough heat to warrant cooling fans or air conditioning (White, 1992).

Two types of transformers are commonly used with UV lamps; namely, electronic and electromagnetic. Electronic ballasts operate at a much higher frequency than electromagnetic ballasts, resulting in lower lamp operating temperatures, less energy use, less heat production, and longer ballast life (DeMers and Renner, 1992).

Typical ballast selection criteria include (DeMers and Renner, 1992):

- Underwriter's Laboratories (UL) approval;
- Compatibility with UV lamps; and
- Waterproof enclosure in remote location.

### **8.2.3 UV Reactor Design**

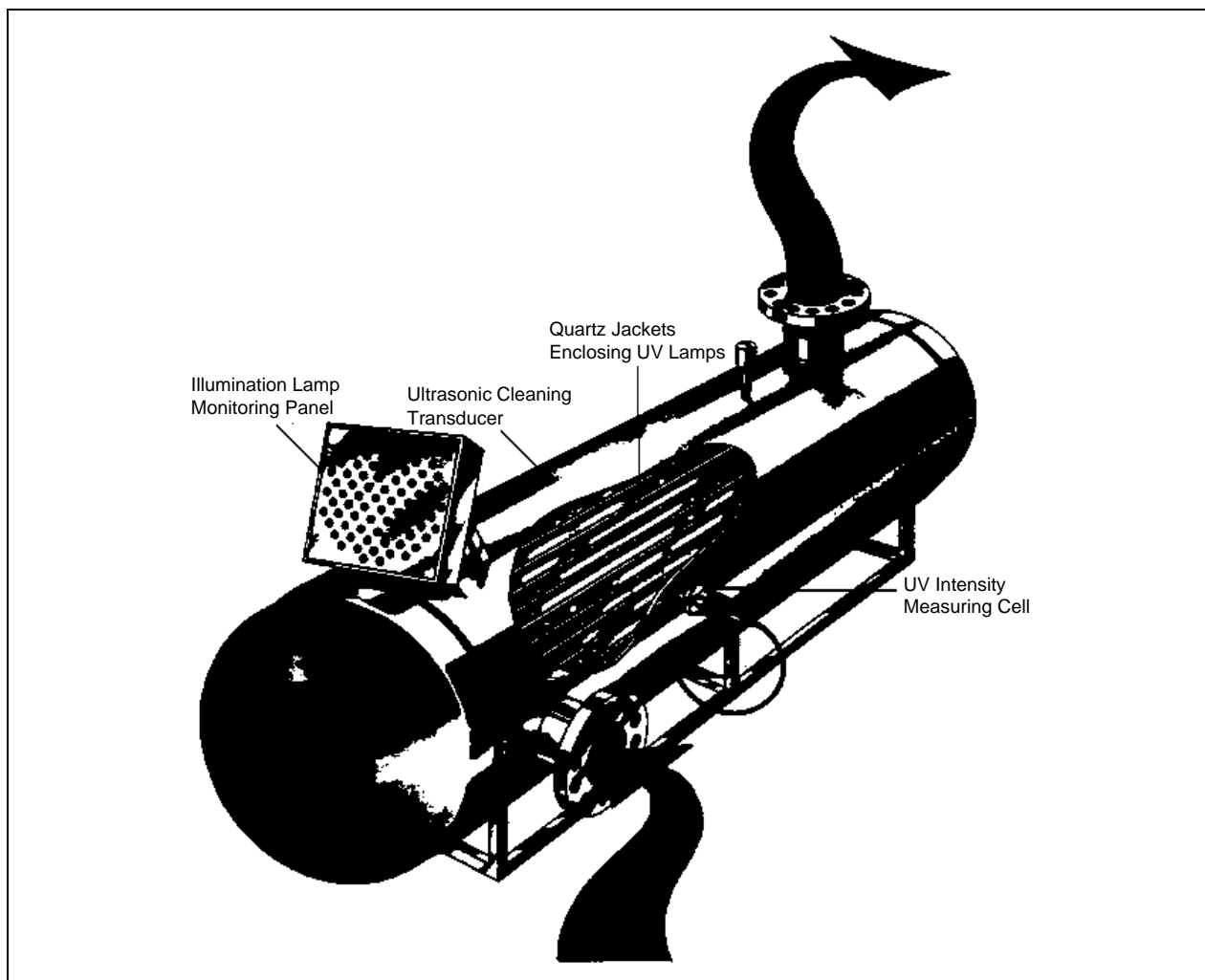
Most conventional UV reactors are available in two types; namely, closed vessel and open channel. For drinking water applications, the closed vessel is generally the preferred UV reactor for the following reasons (USEPA, 1996):

- Smaller footprint;
- Minimized pollution from airborne material;
- Minimal personnel exposure to UV; and
- Modular design for installation simplicity.

Figure 8-1 shows a conventional closed vessel UV reactor. This reactor is capable of providing UV dosages adequate to inactivate bacteria and viruses for flows up to 600 gallons per minute. However, it is incapable of the higher dosages required for protozoan cysts. To increase the dosage, either the number of UV lamps and/or the exposure time should be increased.

Additional design features for conventional UV disinfection systems include:

- UV sensors to detect any drop in UV lamp output intensity;
- Alarms and shut-down systems;
- Automatic or manual cleaning cycles; and
- Telemetry systems for remote installations.



Source: USEPA, 1996.

**Figure 8-1. Closed Vessel Ultraviolet Reactor**

In addition to conventional UV systems, two other UV processes are currently being evaluated for drinking water disinfection:

- Micro-screening/UV; and
- Pulsed UV

Both of these systems profess to provide sufficient UV dose to inactivate *Giardia* cysts and *Cryptosporidium* oocysts. See Section 8.2.3.2, *Emerging UV Reactor Designs*, for further discussion on these emerging technologies.

### **8.2.3.1 Hydraulic Design Considerations**

The major elements that should be considered in the hydraulic design of a UV closed vessel reactor are: dispersion, turbulence, effective volume, residence time distribution, and flow rate (USEPA, 1996).

## Dispersion

Dispersion is the characteristic of water elements to scatter spatially. The ideal UV reactor is plug flow, where water particles are assumed to discharge from the reactor in the same sequence they entered and each element of water passing through the reactor resides in the reactor for the same period of time. An ideal plug flow reactor has no dispersion and is approximated by a long tank with high length-to-width ratio in which dispersion is minimal (USEPA, 1996).

## Turbulence

In addition to plug flow characteristics, the ideal UV reactor has a flow that is turbulent radially from the direction of flow, to eliminate dead zones. This radially turbulent flow pattern promotes uniform application of UV radiation. A negative of having a radially turbulent flow pattern is that some axial dispersion results, thus disrupting the plug flow characteristics. Techniques such as misaligning the inlet and outlet, and using perforated stilling plates, have been used to accommodate the contradicting characteristics of plug flow and turbulence (USEPA, 1996).

### 8.2.3.2 Emerging UV Reactor Designs

Two emerging technologies in UV reactor design are discussed below. All testing of these two systems to date has been under controlled laboratory or field conditions. Both of these technologies require demonstration of efficacy and applicability in real-world treatment operations.

#### Micro-Screening/UV

This unit consists of two treatment chambers, each containing a 2  $\mu\text{m}$  nominal porosity metal screen. Each side of the screen has three 85 watt low pressure mercury lamps, with a total of six lamps per filter. The theoretical minimum dose is 14.6  $\text{mW}\cdot\text{sec}/\text{cm}^2$  at the wavelength of 254 nm. The system is designed to capture *Cryptosporidium* oocysts from the water onto the first screen. The first cycle is set to establish the UV dose. The flow within the first screen chamber is then reversed to backflush to oocysts onto the second screen where the oocysts are trapped until the preset UV dose is reached. Using valves, the pattern of flow is designed to ensure that oocysts are temporarily captured on both filters so that they are exposed to a total preset UV dose, which is totally independent of treated water flowrate (Clancy et al., 1997). Johnson (1997) stated that such a system is capable of achieving total UV doses of 8,000  $\text{mW}\cdot\text{sec}/\text{cm}^2$ , sufficient to inactivate *Giardia* cysts and *Cryptosporidium* oocysts. One drawback of this type of reactor is the headloss created (up to 65 feet) by the 2  $\mu\text{m}$  openings in the screen.

#### Pulsed UV

In the pulsed UV reactor, capacitors build up and deliver electricity in pulses to xenon flash tubes in the center of a 2 inch diameter flash chamber through which water flows. The unit is designed to provide microsecond pulses at 1 to 30 hertz (or per second). With each pulse, the flash tubes give off high intensity, broad band radiation, including germicidal UV radiation, which irradiates the flowing

water with irradiances of  $75 \text{ mW}\cdot\text{sec}/\text{cm}^2$  at 2 cm from the flash tube surface (Clancy et al., 1997). The UV dose can be adjusted by increasing or decreasing the frequency of the pulsing.

### 8.3 Primary Uses and Points of Application

The primary use of UV radiation is to inactivate pathogens to regulated levels. UV radiation is a physical disinfectant that leaves no residual. Therefore, it should be used only as a primary disinfectant followed by a chemical secondary disinfectant to protect the distribution system against coliform proliferation and biofilm formation. See Section 8.4, *Pathogen Inactivation and Disinfection Efficiency*,” for a detailed discussion of disinfection efficiency and limitations.

The most common point of application for UV radiation is the last step in the treatment process train just prior to the distribution system and after filtration. The use of UV disinfection has no impact on other processes at the water treatment facility.

### 8.4 Pathogen Inactivation and Disinfection Efficiency

As opposed to most alternative disinfectants, UV is a physical process that requires a contact time on the order of seconds to accomplish pathogen inactivation (Sobotka, 1993). As with any disinfectant, UV has its limitations. For example, because it is a physical rather than a chemical disinfectant, it does not provide a residual to control pathogen proliferation and biofilm formation in the distribution system. When using UV for primary disinfection, some form of secondary chemical disinfectant is required to maintain water quality within the distribution system.

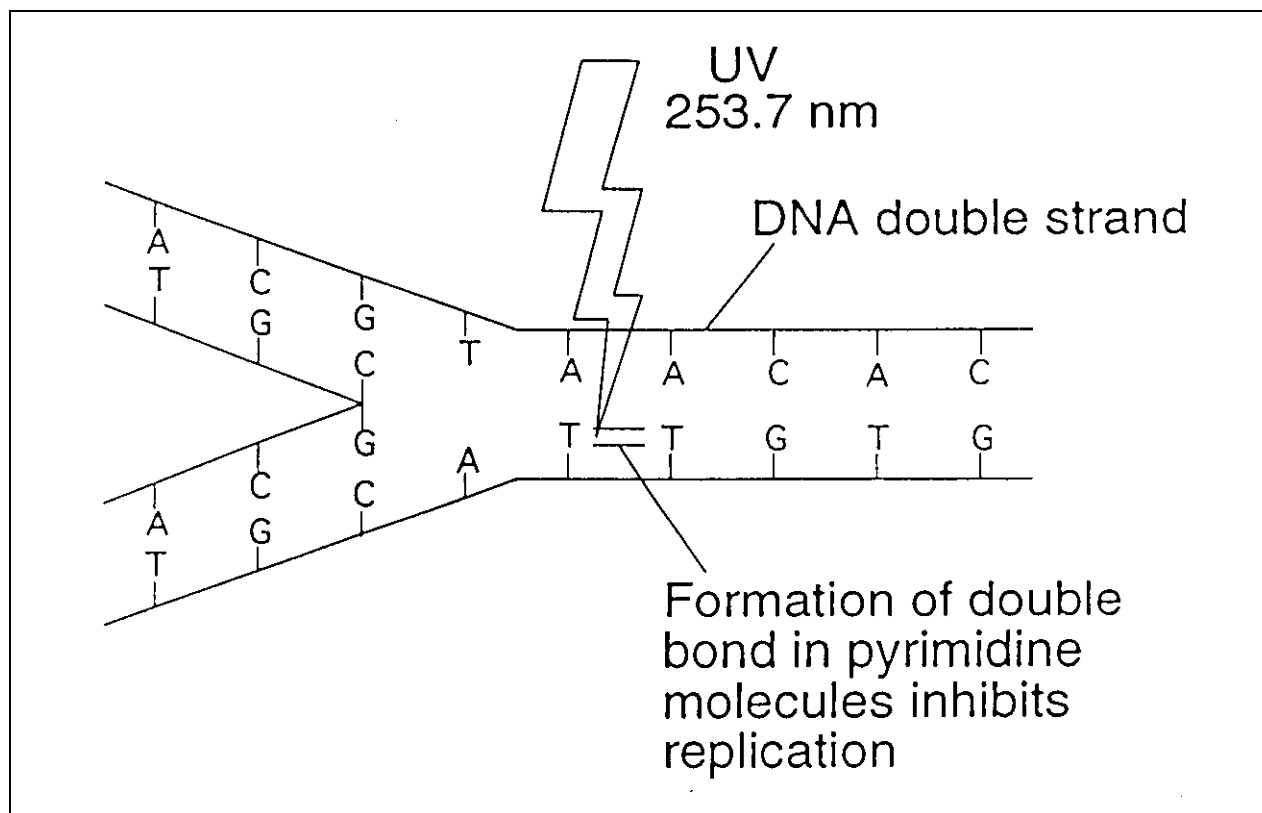
#### 8.4.1 Inactivation Mechanism

UV radiation is efficient at inactivating vegetative and sporous forms of bacteria, viruses, and other pathogenic microorganisms. Electromagnetic radiation in the wavelengths ranging from 240 to 280 nanometers (nm) effectively inactivates microorganisms by irreparably damaging their nucleic acid. The most potent wavelength for damaging deoxyribonucleic acid (DNA) is approximately 254 nm (Wolfe, 1990). Other UV wavelengths, such as 200 nm, have been shown to exhibit peak absorbance in aqueous solutions of DNA (von Sonntag and Schuchmann, 1992); however, there is no practical application for UV inactivation of microorganisms in the wavelength range from 190 to 210 nm (USEPA, 1996).

The germicidal effects of UV light involve photochemical damage to RNA and DNA within the microorganisms. Microorganism nucleic acids are the most important absorbers of light energy in the wavelength of 240 to 280 nm (Jagger, 1967). DNA and RNA carry genetic information necessary for reproduction; therefore, damage to either of these substances can effectively sterilize the organism. Damage often results from the dimerization of pyrimidine molecules. Cytosine (found in both DNA and RNA), thymine (found only in DNA), and uracil (found only in RNA) are the three primary types of pyrimidine molecules. Replication of the nucleic acid becomes very difficult once the pyrimidine molecules are bonded together due to the distortion of the DNA helical

structure by UV radiation (Snider et al., 1991). Moreover, if replication does occur, mutant cells that are unable to replicate will be produced (USEPA, 1996). Figure 8-2 is a schematic of the germicidal inactivation observed with UV radiation.

Two phenomena of key importance when using UV disinfection in water treatment are the dark repair mechanisms and the capability of certain organisms to photoreactivate following exposure to certain light wavelengths. Under certain conditions, some organisms are capable of repairing damaged DNA and reverting back to an active state in which reproduction is again possible. Typically, photoreactivation occurs as a consequence of the catalyzing effects of sunlight at visible wavelengths outside of the effective disinfecting range. The extent of reactivation varies among organisms. Coliform indicator organisms and some bacterial pathogens such as *Shigella* have exhibited the photoreactivation mechanism; however, viruses (except when they have infected a host cell that is itself photoreactive) and other types of bacteria cannot photoreactivate (USEPA, 1980; USEPA, 1986; Hazen and Sawyer, 1992). Because DNA damage tends to become irreversible over time, there is a critical period during which photoreactivation can occur. To minimize the effect of photoreactivation, UV contactors should be designed to either shield the process stream or limit the exposure of the disinfected water to sunlight immediately following disinfection.



Source: Tchobanoglous, 1997.

**Figure 8-2. Germicidal Inactivation by UV Radiation**

## 8.4.2 Environmental Effects

To achieve inactivation, UV should be absorbed into the microorganism. Therefore, anything that prevents UV from reacting with the microorganism will decrease the disinfection efficiency.

Scheible and Bassell (1981) and Yip and Konasewich (1972) reported that pH had no effect on UV disinfection. Several factors that are known to affect disinfection efficiency of UV are:

- Chemical and biological films that develop on the surface of UV lamps;
- Dissolved organics and inorganics;
- Clumping or aggregation of microorganisms;
- Turbidity;
- Color; and
- Short-circuiting in water flowing through the UV contactor.

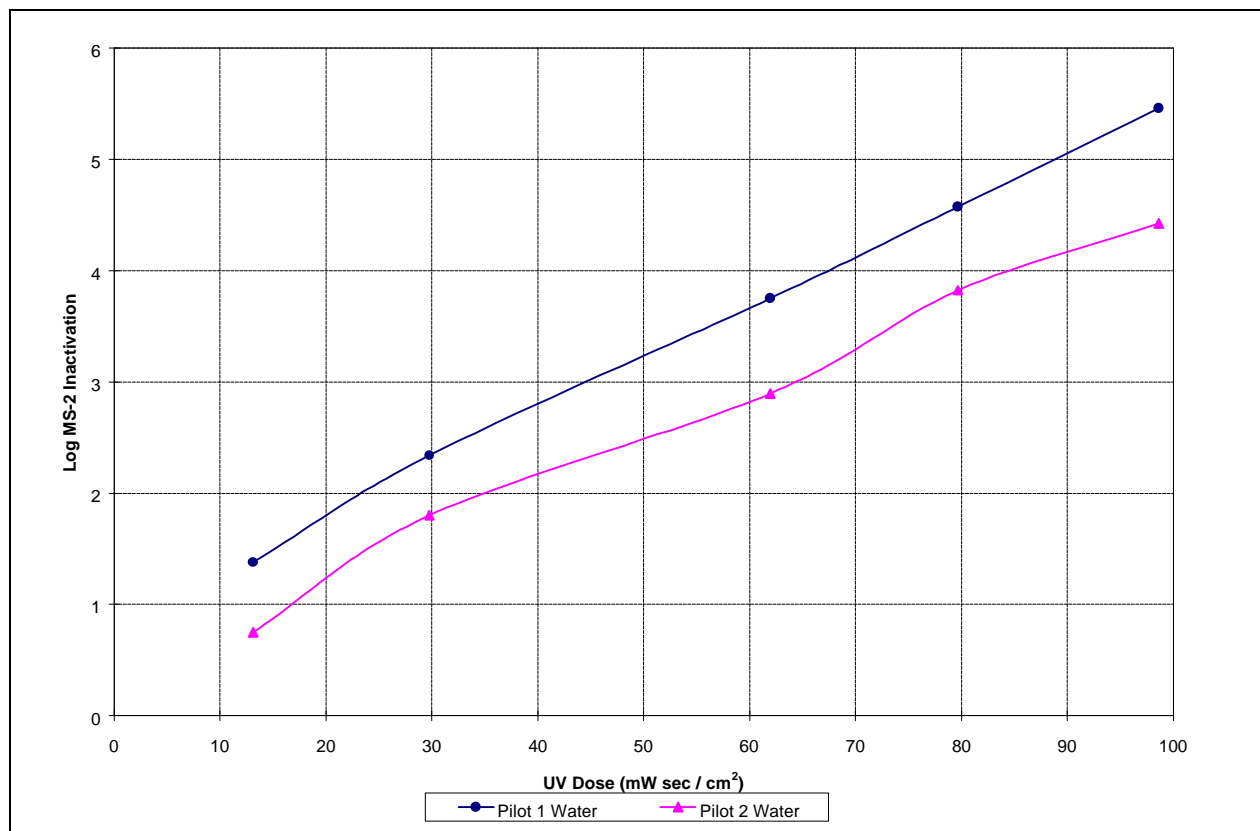
### 8.4.2.1 Chemical Films and Dissolved Organics and Inorganics

Accumulation of solids onto the surface of the UV sleeves can reduce the applied UV intensity and, consequently, disinfection efficiency. In addition to biofilms caused by organic material, buildup of calcium, magnesium, and iron scales have been reported (DeMers and Renner, 1992). Waters containing high concentrations of iron, hardness, hydrogen sulfide, and organics are more susceptible to scaling or plating (i.e., the formation of a thin coat on unit surfaces), which gradually decreases the applied UV intensity. Scaling is likely to occur if dissolved organics are present and inorganic concentrations exceed the following limits (DeMers and Renner, 1992):

- Iron greater than 0.1 mg/L;
- Hardness greater than 140 mg/L; and
- Hydrogen sulfide greater than 0.2 mg/L.

Figure 8-3 shows the UV dose required for inactivation of MS-2 coliphage at two pilot plants. Snicer et al. (1996) concluded that one possible explanation for higher UV dose for the same degree of inactivation required at pilot plant 2 could be the amount of scaling caused by higher iron concentrations experienced at this plant. Iron concentrations at pilot plant 2 were in the range of 0.45 to 0.65 mg/L, which exceed the limit shown above.

A variety of chemical substances can decrease UV transmission (Yip and Konasewich, 1972), including humic acids, phenolic compounds, and lignin sulfonates (Snider et al., 1991), as well as chromium, cobalt, copper, and nickel. It has been reported that coloring agents, such as Orzan S, tea, and extract of leaves reduce intensity within a UV contactor (Huff, 1965). In addition, iron, sulfites, nitrites, and phenols can absorb UV (DeMers and Renner, 1992).



Source: Snicer et al., 1996.

**Figure 8-3. UV Dose Required for Inactivation of MS-2 Coliphage**

#### **8.4.2.2 Microorganism Clumping and Turbidity**

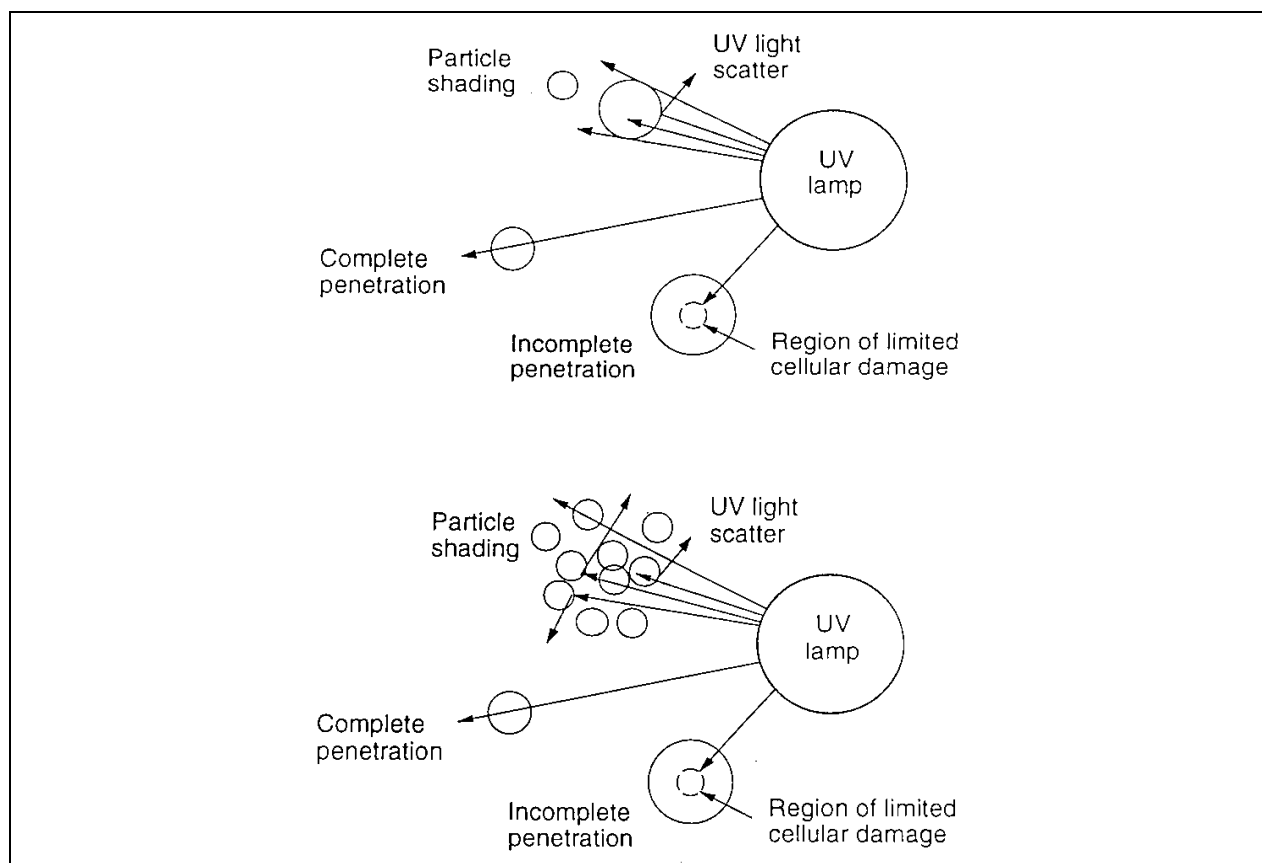
Particles can affect the disinfection efficiency of UV by harboring bacteria and other pathogens, partially protecting them from UV radiation, and scattering UV light (see Figure 8-4). Typically, the low turbidity of ground water results in minimal impact on disinfection efficiency. However, the higher turbidities of surface water can impact disinfection efficiency.

Similar to particles that cause turbidity, microorganism aggregation can impact disinfection efficiency by harboring pathogens within the aggregates and shade pathogens that would otherwise be inactivated.

#### **8.4.2.3 Reactor Geometry and Short Circuiting**

Poor geometry within the UV contactor (which creates spacing between lamps) can leave dead areas where inadequate disinfection occurs (Hazen and Sawyer, 1992). A key consideration to improving disinfection is to minimize the amount of dead spaces where limited UV exposure can occur. Plug flow conditions should be maintained in the contactor; however, some turbulence should be created between the lamps to provide radial mixing of flow. In this manner, flow can be uniformly distributed through the varying regions of UV intensity, allowing exposure to the full range of available UV radiation (Hazen and Sawyer, 1992).

As mentioned earlier, UV systems typically provide contact times on the order of seconds. Therefore, it is extremely important that the system configuration limit the extent of short circuiting.



Source: Tchobanoglous, 1997.

**Figure 8-4. Particle Interactions that Impact UV Effectiveness**

### 8.4.3 Disinfection Efficacy

UV disinfection has been determined to be adequate for inactivating bacteria and viruses. Most bacteria and viruses require relatively low UV dosages for inactivation, typically in the range of 2 to 6 mW·s/cm<sup>2</sup> for 1-log inactivation. Protozoan [oo]cysts, in particular *Giardia* and *Cryptosporidium*, are considerably more resistant to UV inactivation than other microorganisms. Results of several studies investigating the ability of UV to inactivate bacteria, viruses, and protozoa, are described in the following sections.

#### 8.4.3.1 Bacteria and Virus Inactivation

UV doses required for bacteria and virus inactivation are relatively low. One study determined that UV was comparable to chlorination for inactivation of heterotrophic plate count bacteria following treatment using granular activated carbon (Kruithof et al., 1989).

A study of the ability of UV and free chlorine to disinfect a virus-containing ground water showed that UV is a more potent virucide than free chlorine, even after the chlorine residual was increased to 1.25 mg/L at a contact time of 18 minutes (Slade et al., 1986). The UV dose used in this study was 25 mW·s/cm<sup>2</sup>.

Table 8-2 shows results from a more recent pilot plant study (Snicer et al., 1996). As indicated by the different UV doses to obtain the same level of inactivation, water characteristics dramatically impact disinfection efficiency. They believed that the higher concentration of iron in pilot plant 2 water (Figure 8-3) interfered with UV or influenced the aggregation of MS-2 viral particles.

Snicer et al. (1996) also compared the susceptibility of MS-2 coliphage to hepatitis A virus, poliovirus, and rotavirus for 10 ground water sources. Results indicated that MS-2 was found to be approximately 2 to 3 times more resistant to UV disinfection than the three human pathogenic viruses.

**Table 8-2. Doses Required for MS-2 Inactivation**

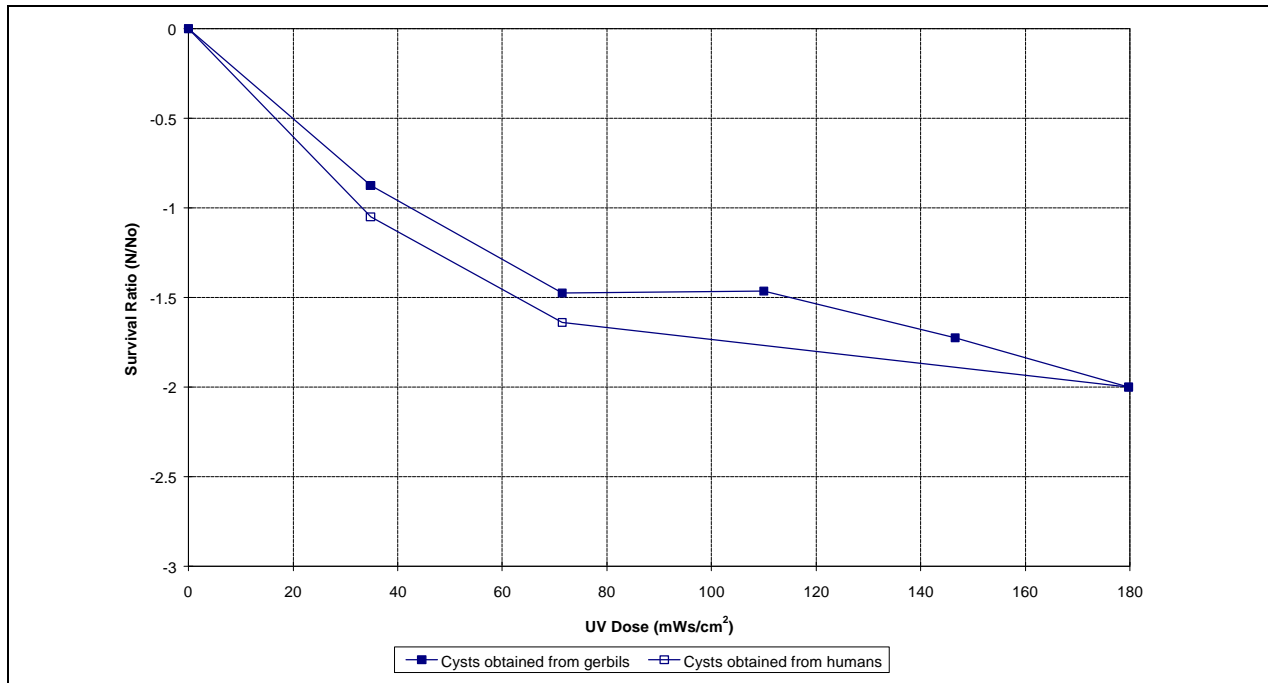
Log MS-2 Inactivation	Pilot Plant 1 (mW·s/cm <sup>2</sup> )	Pilot Plant 2 (mW·s/cm <sup>2</sup> )
1	3.9	15.3
2	25.3	39.3
3	46.7	63.3
4	68	87.4
5	89.5	111.4
6	111.0	135.5

Source: Snicer et al., 1996.

#### 8.4.3.2 Protozoa Inactivation

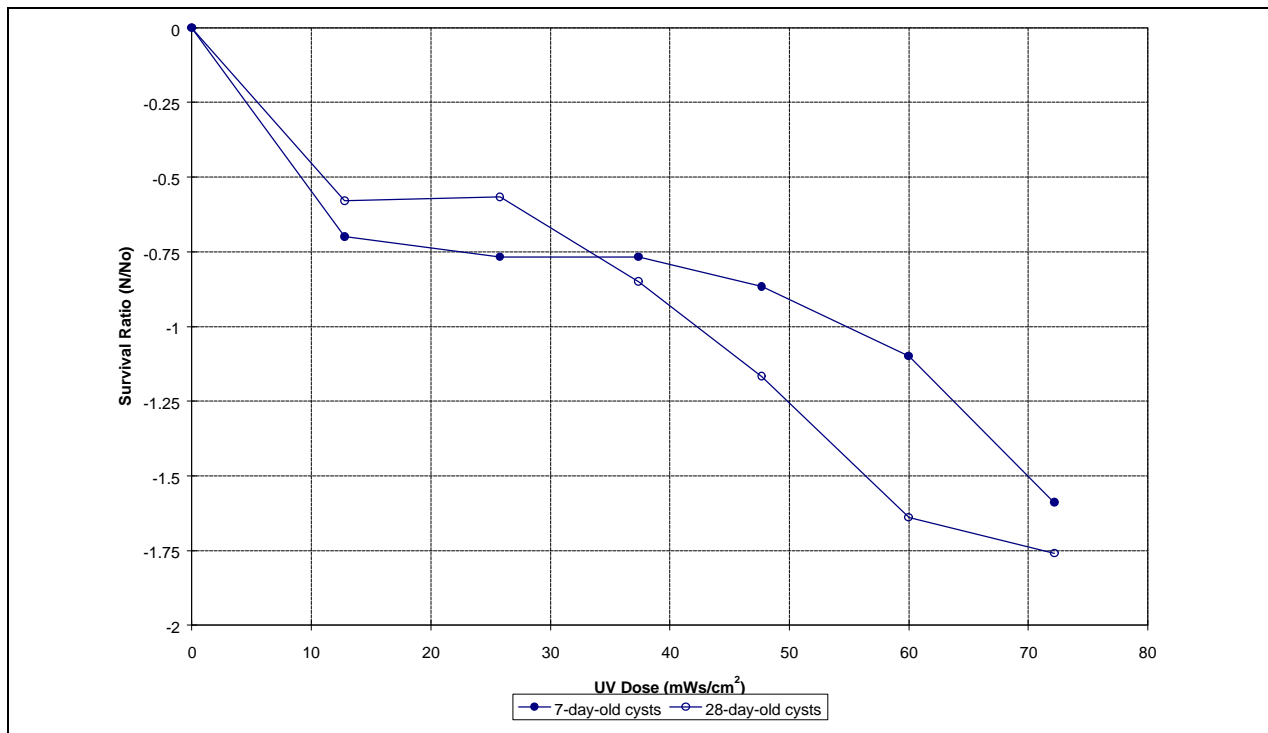
Even though protozoa were once considered resistant to UV radiation, recent studies have shown that ultraviolet light is capable of inactivating protozoan parasites. However, results indicate that these organisms require a much higher dose than that needed to inactivate other pathogens. Less than 80 percent of *Giardia lamblia* cysts were inactivated at UV dosages of 63 mW·s/cm<sup>2</sup> (Rice and Hoff, 1981). A 1-log inactivation of *Giardia muris* cysts was obtained when the UV dose was increased to 82 mW·s/cm<sup>2</sup> (Carlson et al., 1982).

To achieve 2-log inactivation of *Giardia muris* cysts, a minimum ultraviolet light dose of above 121 mW·s/cm<sup>2</sup> is needed. Karanis et al. (1992) examined the disinfection capabilities of ultraviolet light against *Giardia lamblia* cysts extracted from both animals and humans (Karanis et al., 1992). Both groups suffered a 2-log reduction at UV doses of 180 mW·s/cm<sup>2</sup>. Two important factors to consider when determining dose requirements for *Giardia* inactivation are the parasite source and the growth stage of the microorganism (Karanis et al., 1992). Figure 8-5 shows that the source of the parasites is important in determining dose requirements. Figure 8-6 is from a study conducted in 1992 on *Acanthamoeba rhyodes* inactivation (Karanis et al., 1992). These data show that the age of the protozoa can dramatically affect the dose required to achieve a desired level of inactivation.



Source: Karanis et al., 1992.

**Figure 8-5. UV Doses Required to Achieve Inactivation of *Giardia lamblia* Cysts Obtained from Two Different Sources**



Source: Karanis et al., 1992.

**Figure 8-6. Impact of Growth Stage of *A. rhysodes* on the Required UV Dosage to Achieve Inactivation**

Results from recent studies show a potential for inactivating *Cryptosporidium parvum* oocysts using ultraviolet light disinfection. A 2 to 3-log reduction in the viability of *Cryptosporidium parvum* oocysts was achieved using a low-pressure ultraviolet light system with a theoretical minimum intensity of  $14.58 \text{ mW/cm}^2$  and a contact time of 10 minutes (ultraviolet dose of  $8,748 \text{ mW}\cdot\text{s/cm}^2$ ) (Campbell et al., 1995). The combination filter-UV system described by Johnson (1997) is capable of delivering doses as high as  $8,000 \text{ mW}\cdot\text{s/cm}^2$ , sufficient to achieve 2-log *Cryptosporidium* oocyst inactivation.

A pulsed UV process that delivered a minimum dose of  $1,900 \text{ mW}\cdot\text{s/cm}^2$  to any particle within the reactor was found to achieve *Cryptosporidium* oocyst inactivation levels in the range of 2-log. (Clancy et al., 1997). In this study, the reactor residence time was 4.7 seconds and the unit was operated to deliver 46.5 pulses per volume (10 Hz). Each pulse transfers power at the intensity rate of about  $41 \text{ mW}\cdot\text{s/cm}^2$ .

#### 8.4.3.3 UV Dose Summary

UV radiation is considered effective for inactivating bacterial and viral pathogens. UV doses for 2 and 3-log inactivation of viruses are 21 and  $36 \text{ mW}\cdot\text{s/cm}^2$ , respectively (AWWA, 1991). These doses are based on studies of hepatitis A virus inactivation and were derived by applying a safety factor of 3 to the inactivation data. Results from a more recent study on several ground water sources of hepatitis A virus, indicate that a 6 to  $15 \text{ mW}\cdot\text{s/cm}^2$  dose is required for a 4-log inactivation (Snicer et al., 1996). A safety factor was not applied to the doses. A 4-log inactivation of bacteriophage MS-2 is achieved at a dose of  $93 \text{ mW}\cdot\text{s/cm}^2$  (Snicer et al., 1996). In ground water containing high iron levels (0.65 ppm), applying a safety factor of 1.5 to the highest reported dose against viruses will yield a UV dose of  $140 \text{ mW}\cdot\text{s/cm}^2$  for a minimum 4-log inactivation of viruses.

In summary, ultraviolet radiation is effective against bacteria and viruses at low dosages. However, much higher dosages are required for *Cryptosporidium* and *Giardia* inactivation.

## 8.5 Disinfection Byproducts of UV Radiation

Unlike other disinfectants, UV does not inactivate microorganisms by chemical reaction. However, UV radiation causes a photochemical reaction in the organism RNA and DNA. The literature suggests that UV radiation of water can result in the formation of ozone or radical oxidants (Ellis and Wells, 1941; Murov, 1973). Because of this reaction, there is interest in determining whether UV forms similar byproducts to those formed by ozonation or advanced oxidation processes.

### 8.5.1 Ground Water

Malley et al. (1995) analyzed 20 ground water samples for aldehydes and ketones before and after UV radiation. Only one ground water sample, which contained 24 mg/L non-purgeable DOC and was highly colored, contained DBPs after exposure to UV. Low levels of formaldehyde were measure in duplicated experiments for this UV treated ground water sample mentioned above. GC-

ECD chromatographs before and after UV radiation for the other 19 ground waters studied showed significant shifts or unknown peaks after exposure to UV.

Malley et al. (1995) also determined the influence of UV on DBP formation during subsequent chlorination. To examine these effects, the 20 ground water samples were subjected to simulated distribution system (SDS) DBP tests with chlorine, before and after UV radiation. The data indicate that UV radiation did not significantly alter the SDS/DBP formation by chlorine in the ground waters studied.

To examine the effects of varying UV dosages on DBP formation, six new ground water samples (Malley et al., 1995) were subjected to UV dosages of 60, 130, and 200 mW·s/cm<sup>2</sup>. In this case, DBPs were not formed by UV radiation for any of the ground waters tested at any of the UV dosages. A comparison of chromatographs for samples before and after UV radiation, and for each UV dosage, showed no significant differences or appearances of unknown peaks.

### **8.5.2 Surface Water**

UV radiation was found to produce low levels of formaldehyde in the majority of surface waters studied (Malley et al., 1995). The highest formaldehyde concentrations, ranging up to 14 µg/L, were observed in UV treatment of raw water, whereas trace levels (1 to 2 µg/L) were found in UV treatment of conventionally treated water. Since formaldehyde formation was also observed for one of the ground water samples, it appears that UV radiation of waters containing humic matter (i.e., color producing, UV absorbing organic macromolecules) will result in low levels of formaldehyde formation. Chromatographic examination of the surface water samples before and after UV radiation showed no other significant changes in the GC-ECD chromatograms.

Because of the chlorine demands of surface waters, higher chlorine dosages were required for post disinfection following UV radiation. This resulted in larger DBP concentrations than in the ground waters studied (Malley et al., 1995). However, the overall effect of UV radiation on SDS/DBPs was insignificant. As in the ground water studies, UV radiation did not significantly alter the total concentration or the speciation of the disinfection byproducts (e.g., THMs, HAA5, HANs, or HKs).

### **8.5.3 DBP Formation with Chlorination and Chloramination following UV Radiation**

Research results suggest that UV radiation does not directly form DBPs or alter the concentration or species of DBPs formed by post-disinfection (Malley et al., 1995). However, the question of whether UV radiation influences the rate of DBP formation by post-disinfection is important. Several studies have addressed this question. Two surface waters that produced significant concentrations of a wide variety of DBPs in previous tests were chosen as samples. With the chlorine residuals carefully monitored to ensure they were consistent for pre-UV and post-UV samples, the results of the experiments suggested that UV radiation did not significantly affect the rate of DBP formation.

Studies were only performed to determine the pentane extractable DBP formation rate of a surface water sample for varying pH conditions. The results showed that UV radiation did not affect the rate of chloroform formation at pH 8.0 (Malley et al., 1995). Similarly, UV did not affect the DBP formation rate at pH 5.0. At pH 8.0, chloroform was the only pentane extractable detected, whereas at pH 5.0, chloroform, bromodichloromethane, chlorodibromomethane, and 1,1,1-trichloroacetone were formed.

The effects of UV radiation on the DBP formation rate following chloramination were also tested in this study using a surface water sample (Malley et al., 1995). Chloroform, trichloroacetic acid, dichloroacetonitrile (at low levels), and cyanogen chloride (at low levels) were the only detectable DBPs. Chloroform was the only compound formed at pH 8.0, and its rate of formation was not affected by UV radiation. At pH 5.0, chloroform and dichloroacetonitrile were formed, but their rate of formation was unaffected by UV radiation. Data showed that the effects of UV radiation on cyanogen chloride formation at pH 8.0 and pH 5.0 had no significant trends.

In summary, the DBP formation rate studies indicated that UV radiation did not significantly affect DBP formation rates when chlorine or chloramines were used as the post-disinfectant.

## 8.6 Status of Analytical Methods

Ultraviolet radiation intensity meter readings are taken to monitor the output of the UV disinfection system. These readings, coupled with the flow through the UV reactor, are used to determine the UV dosage applied. UV radiation leaves no residual disinfectant behind to monitor. Therefore, some form of secondary chemical disinfectant should be added to protect the distribution system against coliform proliferation and biofilm formation. Analytical methods for these chemical disinfectants are discussed elsewhere in this report.

### 8.6.1 Monitoring of Generated Ultraviolet Radiation

Ultraviolet intensity at 253.7 nm (the predominant wavelength emitted by low pressure mercury vapor lamps) is the water quality parameter used to monitor UV disinfection system output (Snider et al., 1991). The rate of disinfection is directly related to the average intensity of the UV light. Since UV intensity probes can only indicate UV intensity at a single point, there is no practical way to measure the average intensity of a UV system in the field by the operator.

The average intensity is dependent upon the three dimensional lamp geometry. Scheible (1983) developed a mathematical model that calculates the intensity at any point within the UV reactor. This Point Source Summation (PSS) method is used to estimate the average intensity emitted by any specific unit. UV disinfection system manufacturers use this method to design the system. The single point UV intensity probe reading is typically used for routine monitoring of the UV system only.

UV intensity sensors are typically photodiode sensors properly filtered to monitor the lamp intensity in the germicidal range only (DeMers and Renner, 1992). A minimum of two sensors (mounted near

separate lamps) located at the center of each lamp for each reactor is recommended as part of the system controls and instrumentation. White (1992) recommends installing the sensors in the wall of the disinfection chamber at the point of greatest distance from the tube or tubes.

The UV sensors should continuously sense the UV intensity produced in the bank of lamps. The sensor should be field calibrated to account for lamp geometry. Each UV sensor installed should provide a “low UV output” warning and a “low-low UV output” alarm indication that is field adjustable.

#### **8.6.1.1 Ultraviolet Sensor Performance**

To test electronic sensor performance, Snicer et al. (1996) placed a single electronic UV sensor at the center of a UV reactor. The UV sensor converted the UV energy into an electronic signal, which was used to indicate system performance. Initial results indicated that the sensor originally installed with the two UV reactors tended to wear or degrade in performance over time. The original sensor readings in the pilot facility were erratic and had a general downward trend over 6 months of operation. This loss in performance could not be attributed to UV lamp aging. In addition, these readings did not correlate well to actual system performance. After operation of these original sensors for 6 months, the manufacturer was consulted and a new type of sensor was installed into both pilot facilities. The new sensor design specifically addressed the problems encountered during the initial 6 months of the study. These new proprietary sensors performed consistently and sensor readings were shown to correlate well with actual MS-2 coliphage inactivation.

#### **8.6.2 Disinfectant Interferences**

Suspended solids may be the most important water quality parameter impacting UV intensity measurements. Particles can harbor bacteria and at least partially protect them from UV light. Particles can be completely penetrated, partially penetrated, or scatter UV light (Figure 8-4). All particles in water may not absorb UV light. Qualls et al. (1983) suggested that clays merely scatter UV light and, therefore, do little to inhibit performance.

Yip and Konasewich (1972) listed many chemical substances that interfere with UV transmission at 253.7 nm including phenolic compounds, humic acids, and ferric iron.

### **8.7 Operational Considerations**

Onsite pilot plant testing is recommended to determine the efficiency and adequacy of UV disinfection for a specific quality of water. The efficiency test involves injecting select microorganisms into influent water and sampling effluent water to determine survival rates. The National Science Foundation’s Standard 55 for ultraviolet water treatment systems recommends that UV disinfection systems not be used if the UV transmittance is less than 75 percent (NSF, 1991). If the raw water UV transmittance is less than 75 percent, the UV system should be preceded by other treatment processes (to increase UV transmittance) or a different disinfectant should be used.

As previously discussed, some constituents that adversely interfere with UV disinfection performance by either scattering and/or absorbing radiation are iron, chromium, copper, cobalt, sulfites, and nitrites. Care should be taken with chemical processes upstream of UV disinfection process to minimize increasing concentrations of these constituents since disinfection efficiency may be adversely affected.

## **8.7.1 Equipment Operation**

UV disinfection facilities should be designed to provide flexibility in handling varying flow rates. For lower flow rates, a single reactor vessel should be capable of handling the entire flow rate. A second reactor vessel with equal capacity of the first reactor vessel should be provided for redundancy should the first reactor vessel be taken out of service. For higher flow rates, multiple reactor vessels should be provided with lead/lag operation and flow split capacity to balance run time for each reactor vessel, if desired, and to avoid hydraulic overloading. Valves should be provided within the interconnecting piping to isolate one reactor vessel from another. There should also be a positive drainage system to remove water from within a reactor vessel when it is taken out of service.

### **8.7.1.1 UV Lamp Aging**

The output of UV lamps diminishes with time. Two factors that affect their performance are: solarization which is the effect UV radiation has on the UV lamp that causes it to become opaque; and, electrode failure which occurs when electrodes deteriorate progressively each time the UV lamp is cycled on and off. Frequent lamp cycling will lead to premature lamp aging. When determining the requirement for UV disinfection, a 30 percent reduction of UV output should be used to estimate end of lamp. Average life expectancy for low pressure UV lamps is approximately 8,800 hours.

### **8.7.1.2 Quartz Sleeve Fouling**

Fouling of the quartz sleeve reduces the amount of UV radiation reaching the water. The quartz sleeve has a transmissibility of over 90 percent when new and clean. Over time, the surface of the quartz sleeve that is in contact with the water starts collecting organic and inorganic debris (e.g., iron, calcium, silt) causing a reduction in transmissibility (USEPA, 1996). When determining the requirements for UV disinfection, a 30 percent reduction of UV transmission should be used to reflect the effect of quartz sleeve fouling.

## **8.7.2 Equipment Maintenance**

### **8.7.2.1 UV Lamp Replacement**

Adequate space should be provided around the perimeter of the reactor vessels to allow access for maintenance and replacement of UV lamps. With modular electrical fittings, lamp replacement consists of unplugging the pronged connection of the old lamp and plugging in the new.

### **8.7.2.2 Quartz Sleeve Cleaning**

Quartz sleeve cleaning may be accomplished by physical or chemical means. Physical alternatives include:

- Automatic mechanical wiper;
- Ultrasonic devices;
- High water pressure wash; and
- Air scour.

Chemical cleaning agents include sulfuric or hydrochloric acid. A UV reactor vessel may contain one or more physical cleaning system with provision for an occasional chemical cleaning.

### **8.7.2.3 Miscellaneous**

Effective maintenance of a UV system will involve:

- Periodic checks for proper operation;
- Calibration of intensity meter for proper sensitivity; and
- Inspect and/or clean reactor vessel interior.

### **8.7.3 Standby Power**

Producing UV radiation requires electricity to power the electronic ballasts, which in turn power the UV lamps. Since disinfection is of utmost importance in producing potable water, the UV system should remain in service during periods of primary power failure. A dual power feed system or essential circuitry powered by a standby generator are typical ways to achieve the desired reliability. Each low pressure UV lamp requires approximately 100 Watts of standby power. A second precaution that should be considered is not powering the UV system from the same motor control center (MCC) that powers variable frequency drives (VFDs). The electronic ballasts produce harmonics that may require mitigation (active harmonic filters) for the VFDs.

## 8.8 Summary Table

**Table 8-3. Summary of UV Disinfection**

Consideration	Description
Generation	Low pressure and medium pressure UV lamps available.
Primary uses	Primary physical disinfectant; requires secondary chemical disinfectant for residual in distribution system.
Inactivation efficiency	Very effective against bacteria and viruses at low dosages (5-25 mW•s/cm <sup>2</sup> for 2-log removal and 90-140 mW•s/cm <sup>2</sup> for 4-log removal). Much higher dosage required for <i>Cryptosporidium</i> and <i>Giardia</i> (100-8,000 mW•s/cm <sup>2</sup> for 2-log removal).
Byproduct formation	Minimal disinfection byproducts produced.
Limitations	Limited experience and data with flows greater than 200 GPM. Water with high concentrations of iron, calcium, turbidity, and phenols may not be applicable to UV disinfection.
Point of application	Prior to distribution system.
Special considerations	Extremely high UV dosages for <i>Cryptosporidium</i> and <i>Giardia</i> may make surface water treatment impractical.

## 8.9 References

1. AWWA (American Water Works Association). 1991. *Guidance Manual for Compliance with the Filtration and Disinfection Requirements for Public Water Systems Using Surface Water Sources*.
2. AWWA and ASCE (American Society of Civil Engineers). 1990. *Water Treatment Plant Design*. Second edition, McGraw-Hill, Inc., New York, NY.
3. Campbell, A.T., et al. 1995. "Inactivation of Oocysts of *Cryptosporidium parvum* by Ultraviolet Radiation." *Water Res.* 29(11):2583.
4. Carlson, D. A., et al. 1982. *Project Summary: Ultraviolet Disinfection of Water for Small Water Supplies*. Office of Research and Development, U.S. Environmental Protection Agency; Cincinnati, OH, EPA/600/S2-85/092.
5. Clancy, J.L., T.M. Hargy, M.M. Marshall, and J.E. Dyksen. 1997. "Inactivation of *Cryptosporidium parvum* Oocysts in Water Using Ultraviolet Light." Conference proceedings, AWWA International Symposium on *Cryptosporidium* and Cryptosporidiosis, Newport Beach, CA.

6. Combs, R., and P. McGuire. 1989. "Back to Basics - The Use of Ultraviolet Light for Microbial Control." *Ultrapure Water Journal*. 6(4):62-68.
7. DeMers, L.D. and R.C. Renner. 1992. *Alternative Disinfection Technologies For Small Drinking Water Systems*. AWWARF.
8. Ellis, C., and A.A. Wells. 1941. *The Chemical Action of Ultraviolet Rays*. Reinhold Publishing Co., New York, NY.
9. Hazen and Sawyer. 1992. *Disinfection Alternatives for Safe Drinking Water*. Van Nostrand Reinhold, New York, NY.
10. Huff, C. B. 1965. "Study of Ultraviolet Disinfection of Water and Factors in Treatment Efficiency." *Public Health Reports*. 80(8):695-705.
11. Jagger, J. 1967. *Introduction to Research in Ultraviolet Photobiology*. Prentice-Hall Inc., Englewood Cliffs, NJ.
12. Johnson, R.C. 1997. "Getting the Jump on Cryptosporidium with UV." *Opflow*. 23(10):1.
13. Karanis, P., et al. 1992. "UV Sensitivity of Protozoan Parasites." *J. Water Supply Res. Technol. Aqua*. 41(2):95.
14. Kruithof, J.C., et al. 1989. Summaries, *WASSER BERLIN '89*; International Ozone Association, European Committee, Paris.
15. Malley Jr., J.P, J.P. Shaw, and J.R. Ropp. 1995. "Evaluations of Byproducts by Treatment of Groundwaters With Ultraviolet Irradiation." AWWARF and AWWA, Denver, CO.
16. Murov, S.L. 1973. *Handbook of Photochemistry*. Marcel Dekker, New York, NY.
17. NSF (National Science Foundation). 1991. *NSF Standard 55: Ultraviolet Water Treatment Systems*. National Sanitation Foundation, Ann Arbor, MI.
18. Qualls, R., Flynn, M., and Johnson, J. 1983. "The Role of Suspended Particles in Ultraviolet Disinfection." *J. Water Pollution Control Fed*. 55(10):1280-1285.
19. Rice, E.W. and J.C. Hoff. 1981. "Inactivation of *Giardia lamblia* Cysts by Ultraviolet Irradiation." *Appl. Environ. Microbiol*. 42:546-547.
20. Scheible, O.K. and C.D. Bassell. 1981. *Ultraviolet Disinfection Of A Secondary Wastewater Treatment Plant Effluent*. EPA-600/2-81-152, PB81-242125, U.S. Environmental Protection Agency; Cincinnati, OH.

21. Scheible, O.K. 1983. "Design and Operation of UV Systems." Presented at Water Pollution Control Federation Annual Conference, Cincinnati, OH.
22. Slade, J. S., N.R. Harris, and R.G. Chisholm. 1986. "Disinfection of Chlorine Resistant Enteroviruses in Ground Water by Ultraviolet Radiation." *Water Sci. Technol.* 189(10):115-123.
23. Snicer, G.A., J.P. Malley, A.B. Margolin, and S.P. Hogan. 1996. "Evaluation of Ultraviolet Technology in Drinking Water Treatment." Presented at AWWA Water Quality Technology Conference, Boston, MA.
24. Snider, K.E., J.L. Darby, and G. Tchobanoglous. 1991. *Evaluation of Ultraviolet Disinfection For Wastewater Reuse Applications In California*. Department of Civil Engineering, University of California, Davis.
25. Sobotka, J. 1993. "The Efficiency of Water Treatment and Disinfection by Means of Ultraviolet Radiation." *Water Sci. Technol.* 27(3-4):343-346.
26. Tchobanoglous, G.T. 1997. "UV Disinfection: An Update." Presented at Sacramento Municipal Utilities District Electrotechnology Seminar Series. Sacramento, CA.
27. USEPA (U.S. Environmental Protection Agency). 1996. *Ultraviolet Light Disinfection Technology in Drinking Water Application - An Overview*. EPA 811-R-96-002, Office of Ground Water and Drinking Water.
28. USEPA. 1986. *Design Manual: Municipal Wastewater Disinfection*. EPA/625/1-86/021, Office of Research and Development, Water Engineering Research Laboratory, Center for Environmental Research Information, Cincinnati, OH
29. USEPA. 1980. *Technologies for Upgrading Existing and Designing New Drinking Water Treatment Facilities*. EPA/625/4-89/023, Office Drinking Water.
30. Von Sonntag, C. and H. Schuchmann. 1992. "UV Disinfection of Drinking Water and By-Product Formation - Some Basic Considerations." *J. Water SRT-Aqua*. 41(2):67-74.
31. White, G.C. 1992. *Handbook of Chlorination and Alternative Disinfectants*. Van Nostrand Reinhold, New York, NY.
32. Wolfe, R.L. 1990. "Ultraviolet Disinfection of Potable Water." *Environ. Sci. Tech.* 24(6):768-773.
33. Yip, R.W. and D.E. Konasewich. 1972. "Ultraviolet Sterilization Of Water - Its Potential And Limitations." *Water Pollut. Control (Canada)*. 14:14-18.

THIS PAGE INTENTIONALLY LEFT BLANK

<b>8.</b>	<b>ULTRAVIOLET RADIATION .....</b>	<b>8-1</b>
8.1	UV CHEMISTRY (PHOTOCHEMICAL).....	8-1
8.1.1	UV Radiation .....	8-1
8.1.2	UV Disinfection Reactions .....	8-2
8.1.3	Process Variables .....	8-2
8.2	GENERATION.....	8-3
8.2.1	UV Lamps.....	8-4
8.2.2	Ballasts .....	8-4
8.2.3	UV Reactor Design .....	8-5
8.3	PRIMARY USES AND POINTS OF APPLICATION .....	8-8
8.4	PATHOGEN INACTIVATION AND DISINFECTION EFFICIENCY .....	8-8
8.4.1	Inactivation Mechanism.....	8-8
8.4.2	Environmental Effects .....	8-10
8.4.3	Disinfection Efficacy .....	8-12
8.5	DISINFECTION BYPRODUCTS OF UV RADIATION .....	8-15
8.5.1	Ground Water.....	8-15
8.5.2	Surface Water.....	8-16
8.5.3	DBP Formation with Chlorination and Chloramination following UV Radiation.....	8-16
8.6	STATUS OF ANALYTICAL METHODS.....	8-17
8.6.1	Monitoring of Generated Ultraviolet Radiation .....	8-17
8.6.2	Disinfectant Interferences .....	8-18
8.7	OPERATIONAL CONSIDERATIONS.....	8-18
8.7.1	Equipment Operation.....	8-19
8.7.2	Equipment Maintenance .....	8-19
8.7.3	Standby Power .....	8-20
8.8	SUMMARY TABLE.....	8-21
8.9	REFERENCES .....	8-21

Table 8-1. Water Quality and Associated UV Measurements..... 8-3

Table 8-2. Doses Required for MS-2 Inactivation .....

Table 8-3. Summary of UV Disinfection..... 8-21

Figure 8-1. Closed Vessel Ultraviolet Reactor..... 8-6

Figure 8-2. Germicidal Inactivation by UV Radiation .....

Figure 8-3. UV Dose Required for Inactivation of MS-2 Coliphage..... 8-11

Figure 8-4. Particle Interactions that Impact UV Effectiveness .....

Figure 8-5. UV Doses Required to Achieve Inactivation of *Giardia lamblia* Cysts Obtained from Two Different

Sources..... 8-14

Figure 8-6. Impact of Growth Stage of *A. rhyssodes* on the Required UV Dosage to Achieve Inactivation..... 8-14

# 9. COMBINED DISINFECTANTS

---

Multiple disinfectants, the sequential or simultaneous use of two or more disinfectants, have been used with increasing frequency in recent years. This trend is attributed to the fact that:

- Less reactive disinfectants, such as chloramines, have proven to be quite effective in reducing DBPs formed during disinfection and are more effective for controlling biofilms in the distribution system.
- Regulatory and consumer pressure to produce water that has been disinfected to achieve high inactivation for various pathogens, has pushed the industry towards more effective disinfectants. Sometimes more effective disinfection meant using higher disinfectant doses which also produces more DBPs.
- Recent research has shown that the application of sequential disinfectants is more effective than the added effect of the individual disinfectants. This process where two (or more) disinfectants produce a synergistic effect by either simultaneous or sequential application to achieve more effective pathogen inactivation, is referred to as *interactive disinfection* in this manual.

This chapter discusses recent industry applications of multiple disinfectants to meet the varied requirements for inactivation and reduction in DBPs. The initial discussion focuses on traditional disinfectants used in primary and secondary application. This is followed by a discussion of interactive disinfectants where two disinfectants are applied together specifically to achieve primary disinfection. Note that the IESWTR does not have any provision for additional credits for interactive disinfection or taking additional credit for the synergistic effects from interactive disinfection. Until such credit is established, interactive disinfection is considered an emerging technology. This chapter does not discuss mixed oxidant systems, which are designed to generate mixed oxidants on-site for drinking water disinfection, and are also considered an emerging technology.

## 9.1 Primary and Secondary Disinfectants

By separating the inactivation function and residual disinfection function in water treatment, each can be optimized independently. Thus, the combination of disinfectants currently used in disinfection is typically identified as a primary or secondary disinfectant, as follows:

- Primary disinfection refers to the inactivation of microorganisms to meet the regulatory bacteriological requirements. This requirement typically is met by achieving certain CT requirements to assure a target log inactivation of target organisms as set forth in the Surface Water Treatment Rule (SWTR) (AWWA, 1991).
- Secondary disinfection refers to application of a disinfectant to meet regulatory requirements for distribution system bacteriological quality as set forth in the Total Coliform Rule (TCR). The SWTR requires that a residual disinfectant be measured in the distribution system, or that the bacteriological quality meet certain standards (heterotrophic plate count (HPC) less than 500/100mL).

To be an effective primary disinfectant, the disinfectant should effectively inactivate the target organism. Table 9-1 lists potential primary disinfectants as discussed in Chapters 2 through 8.

**Table 9-1. Potential Primary Disinfectants**

Target Organism	Potential Primary Disinfectants	
	With Filtration <sup>1</sup>	Without Filtration
Coliform Bacteria	Chlorine Chloramines Chlorine dioxide Ozone UV Interactive disinfection	Chlorine Chlorine dioxide Interactive disinfection <sup>3</sup>
Giardia cysts	Chlorine <sup>2</sup> Chlorine dioxide <sup>2</sup> Ozone <sup>2</sup> Interactive disinfection	Chlorine <sup>2</sup> Chlorine dioxide <sup>2</sup> Interactive disinfection <sup>3</sup>
Viruses	Chlorine <sup>2</sup> Chlorine dioxide <sup>2</sup> Ozone <sup>2</sup> UV <sup>2</sup> Interactive disinfection	Chlorine <sup>2</sup> Chlorine dioxide <sup>2</sup> UV <sup>2</sup> Interactive disinfection <sup>3</sup>
Cryptosporidium oocysts	Chlorine dioxide Ozone Interactive disinfection	Chlorine dioxide Interactive disinfection <sup>3</sup>

<sup>1</sup> Natural or treatment filtration reduces disinfection inactivation requirements.

<sup>2</sup> Inactivation credit established in SWTR.

<sup>3</sup> Any interactive disinfection that uses ozone or peroxone without filtration is strongly discouraged.

As discussed in earlier chapters, certain disinfectants (e.g., ozone, UV, peroxone, and in some cases chlorine dioxide), while being effective disinfectants, do not leave a long-lasting residual disinfectant. Therefore, secondary disinfection is limited to those disinfectants that remain stable in the distribution system. In order of decreasing stability, these secondary disinfectants are chloramines, chlorine, and chlorine dioxide.

Based on the above, the combinations of disinfectants that are viable options to meet the disinfection requirements can be determined for various treatment trains. These combinations are shown for various treatment objectives. Note that the treatment objectives are dependent on the treatment currently in place.

To meet DBP, and specifically, THM limits, several studies have evaluated the application of various primary/secondary disinfectants. Table 9-2 presents the typical application of these combined disinfectants.

**Table 9-2. Primary/Secondary Disinfectant Combinations and Typical Applications in Water Treatment**

Primary / Secondary	Typical application*	Comment
Chlorine/Chlorine	Low THMFP raw water, low TOC, conventional treatment with optimal coagulation.	Most commonly used disinfection scheme. Effective system.
Chlorine/Chloramine	Moderate THM production situation, typically with conventional treatment.	Chlorine to provide disinfection and monochloramine to limit DBP formation.
Chlorine dioxide/Chlorine dioxide	High DBP production, require filter process to remove <i>Cryptosporidium</i> , low chlorine dioxide demand in treated water.	Primary and secondary usage requires a limit on chlorine dioxide dose to reduce residual chlorate/chlorite.
Chlorine dioxide/Chloramine	High DBP production, require filtration to remove <i>Cryptosporidium</i> .	Primary chlorine dioxide dose limited to residual chlorate/chlorite. Stable, low reactive secondary disinfectant.
Ozone/Chlorine	Moderate DBP formation, direct or no filtration, low THMFP.	Highly effective disinfection to achieve high log inactivation; low THMFP to accept free chlorine.
Ozone/Chloramine	Moderate DBP formation, direct or no filtration, higher THMFP.	Highly effective disinfection to achieve high log inactivation, low THMFP to require combined chlorine residual.
UV/Chlorine	Requires membrane treatment to provide effective <i>Giardia</i> and <i>Cryptosporidium</i> removal. UV only for virus inactivation; ground water disinfection; low THMFP.	Rare application but feasible in special circumstances. Little <i>Giardia</i> and no <i>Cryptosporidium</i> inactivation.
UV/Chloramine	Requires membrane treatment to provide effective <i>Giardia</i> and <i>Cryptosporidium</i> removal. UV only for virus inactivation; ground water disinfection, moderate THMFP.	Rare application but feasible in special circumstances. No <i>Giardia</i> or <i>Cryptosporidium</i> inactivation.

Notes:

\* Low DBP formation is defined as producing less than the Stage 2 D/DBP Proposed Standard (less than 0.040 mg/L TTHM; less than 0.030 mg/L HAA5). Moderate DBP formation is defined as producing less than the Stage 1 D/DBP Standard and more than the Stage 2 D/DBP Proposed Standard. High DBP formation is defined as producing more than the Stage 1 D/DBP Standard (greater than 0.080 mg/L TTHM; greater than 0.060 mg/L HAA5).

### 9.1.1 DBP Formation with Various Primary and Secondary Disinfectant Combinations

The concentrations and types of DBPs formed depend on, among other things, the combination of disinfectants used to achieve primary and secondary disinfection and the water quality. For example, under certain water quality conditions, ozone/chloramine disinfection is known to produce lower THM concentrations than chlorine/chloramine disinfection. However, the ozone/chloramine alternative can increase the formation of other DBPs such as aldehydes and BOM. No single

combination of disinfectants is applicable to all situations. Table 9-3 summarizes the potential DBPs formed by various combinations of disinfectants. The disinfection byproducts referenced here are discussed in greater detail in earlier chapters of this manual.

**Table 9-3. DBPs Associated with Various Combined Oxidation/Disinfection Processes**

Alternative			Potential DBPs	Remarks
Preoxidation	Primary Disinfection	Secondary Disinfection		
Chlorine	Chlorine	Chlorine	XDBPs*	Maximum XDBP formation compared to all other strategies. Principal components are TTHMs and HAAs.
			Aldehydes	Formed at relatively low levels.
Chlorine	Chlorine	Chloramine	XDBPs Cyanogen chloride Cyanogen bromide	Formation of XDBPs (specifically TTHMs and HAA5s) significantly reduced compared to chlorine/ chlorine/ chlorine.
			Aldehydes	Formed at relatively low levels.
Chlorine dioxide	Chlorine dioxide	Chlorine	XDBPs	Formation of XDBPs may be decreased by delaying the point of chlorine addition.
			Aldehydes, carboxylic acids, maleic acids	Formed at relatively low levels.
			Chlorate Chlorite	Chlorite is a major breakdown product of chlorine dioxide.
Chlorine dioxide	Chlorine dioxide	Chloramine	XDBPs	Formation of XDBPs (especially TTHMs and HAA5s) minimized by avoiding use of free chlorine.
			Aldehydes, carboxylic acids, maleic acid	Formed at relatively low levels.
			Chlorate Chlorite	Chlorite is a major breakdown product of chlorine dioxide.
Potassium permanganate	Chlorine	Chlorine	XDBPs	Formation of XDBPs may be decreased by delaying the point of chlorine addition.
			Aldehydes	Formed at relatively low levels.
Potassium permanganate	Chlorine	Chloramine	XDBPs Cyanogen chloride Cyanogen bromide	Formation of XDBPs may further be decreased compared to potassium permanganate/ chlorine/ chlorine.
			Aldehydes	Formed at relatively low levels.
Ozone	Ozone	Chlorine	XDBPs	Formation of certain XDBPs may increase or decrease compared to chlorine/ chlorine/ chlorine. Brominated byproducts may be of concern when bromides are present in the raw water.
			Bromate, Aldehydes, carboxylic acids	Although formed at relatively high levels significant amounts of this BOM can be removed through biological filtration.
Ozone	Ozone	Chloramine	XDBPs Cyanogen chloride  Cyanogen bromide	Formation of XDBPs (especially TTHMs) minimized by avoiding use of free chlorine.
			Bromate, Aldehydes, carboxylic acids	Although formed at relatively high levels significant amounts of this BOM can be removed through biological filtration.

Alternative			Potential DBPs	Remarks
Preoxidation	Primary Disinfection	Secondary Disinfection		
Peroxone	Chlorine or Ozone	Chlorine	XDBPs	Formation of certain XDBPs may increase or decrease compared to chlorine/ chlorine/ chlorine.
			Bromate, Aldehydes, carboxylic acids	Although formed at relatively high levels significant amounts of this BOM can be removed through biological filtration. Also, the formation of bromate will increase if peroxone is used.
Peroxone	Chlorine or Ozone	Chloramine	XDBPs Cyanogen chloride Cyanogen bromide	Formation of XDBPs may decrease compared to peroxone/ chlorine/ chlorine.
			Bromate, Aldehydes, carboxylic acids	Although formed at relatively high levels significant amounts of this BOM can be removed through biological filtration. Also, the formation of bromate will increase if peroxone is used.
Chlorine	UV**	Chloramine	XDBPs Cyanogen chloride Cyanogen bromide	May form XDBP from pre-oxidation.
			Aldehydes	Low levels.
Potassium Permanganate	UV**	Chloramine	XDBPs	Very low due to less reactive oxidants.
			Aldehydes, carboxylic acids	Very low, if any, due to less reactive oxidants.

\* XDBPs - Halogenated Disinfection Byproducts.

\*\* Although "conventional" UV use as primary disinfectant is limited to virus inactivation (may require membrane filtration), pulsed UV may be able to inactivate *Giardia* and *Cryptosporidium*.

Source: Adopted in part from USEPA, 1992; Richardson et al., 1994.

Raw water chlorination, applied prior to natural organic matter (NOM) removal processes, combined with chlorination for residual disinfection produces the greatest concentrations of halogenated DBPs. Studies indicate that pre-oxidation of raw water with ozone or chlorine dioxide can reduce the formation of halogenated DBPs because it shifts the point of chlorine application from raw water to settled or filtered water which has lower DBP precursor concentrations (MWDSC and JMM, 1989).

The use of ozone can reduce the formation of halogenated byproducts in waters containing low concentrations of bromide. However, ozone increases BOM and may encourage bacterial growth in the distribution system. Removal of AOC with biological filtration (e.g., biological activated carbon) reduces the potential for bacterial growth in the distribution system. The use of chloramines as a secondary disinfectant instead of chlorine shortens the chlorine contact time and thus reduces the formation of chlorinated byproducts. However, chloramine produces by-products of its own (cyanogen chloride and cyanogen bromide). In addition, a short chlorine contact time prior to ammonia addition will help inactivate heterotrophic plate count bacteria that are found in the effluent of a biologically active filter. Bench or pilot studies will be required to evaluate the trade-offs in DBP formation for various disinfectant combinations for a specific application.

The application of ozone should be carefully considered because it produces aldehydes, aldoketoacids, and carboxylic acids. However, these can be removed in a biologically active filter.

In bromide-containing waters, ozonation can increase the formation of brominated organic DBPs and form bromate.

In pilot plant studies for water containing low concentrations of bromide, Lykins et al. (1991) determined that ozonation followed by chloramination produced the lowest levels of halogenated disinfection byproducts. However, this is not applicable to source waters containing significant bromide concentrations due to the potential for bromate formation and brominated THMs and HAAs. The addition of chlorine dioxide will produce chlorite and chlorate and may form some oxygenated DBPs (e.g., maleic acids).

### 9.1.2 Impact of Modifying Disinfection Practices

EPA and the Association of Metropolitan Water Agencies funded a 2-year study of 35 water treatment facilities to evaluate DBP production. Among four of the facilities, eleven alternative disinfection strategies were instigated to evaluate the difference in DBP production from the plants' previously existing disinfection strategies. Three reports (MWDSC and JMM, 1989; Jacangelo, 1989; USEPA, 1992) analyzed and documented different aspects of the study. Table 9-4 shows the eleven potential strategies used for primary and secondary disinfection. Table 9-5 shows the changes in DBP production observed in the four plants after eight of these new strategies were implemented. Following are overviews of the potential implications of these strategies, as detailed by the three reports.

**Table 9-4. Strategies for Primary and Secondary Disinfectants**

<i>Base Disinfection Condition</i>	<i>Modified Disinfection Practice</i>
Chlorine/Chlorine	Chlorine/Chloramine
Chlorine/Chlorine	Chloramine/Chloramine
Chlorine/Chlorine	Chlorine Dioxide/Chloramine
Chlorine/Chlorine	Ozone/Chlorine
Chlorine/Chlorine	Ozone/Chloramine
Chlorine/Chlorine	Chlorine Dioxide/Chlorine
Chlorine/Chlorine	Chlorine Dioxide/Chlorine Dioxide
Chlorine/Chloramine	Ozone/Chloramine
Chlorine/Chloramine	Chlorine Dioxide/Chloramine
Ozone/Chlorine	Ozone/Chloramine
Chloramine/Chloramine	Ozone/Chloramine

Note: Disinfectants are listed as primary disinfectant/secondary disinfectant

Table 9-5. Impacts of Disinfection Practice on DBP Formation

Disinfection Byproduct	Change in Disinfection Practice (Primary Disinfectant/Secondary Disinfectant)				
	Chlorine/Chlorine to Chlorine/Chloramine	Chlorine/Chlorine to Ozone/Chlorine		Chlorine/Chloramine to Ozone/Chloramine	Chlorine/Chlorine to Chloramines/Chloramines
	Utility #7	Utility #19	Utility #36	Utility#7	Utility #36
Total Trihalomethanes	decrease	decrease	no change	decrease	decrease
Total Haloacetic Acids	decrease	decrease	no change	decrease	decrease
Total Haloacetonitriles	decrease	decrease	no change	decrease	decrease
Total Haloketones	decrease	no change	increase	increase	decrease
Total Aldehydes	not analyzed	not analyzed	increase	not analyzed	decrease
Chloropicrin	no change	increase	increase	decrease	no change
Chloral Hydrate	decrease	increase	increase	decrease	decrease
Cyanogen Chloride	no change	not analyzed	no change	no change	increase
Disinfection By-Product	Change in Disinfection Practice (Primary Disinfectant/Secondary Disinfectant)				
	Ozone/Chlorine to Ozone/Chloramine	Chloramines/Chloramines to Ozone/Chloramines		Chlorine/Chlorine to Ozone/Chloramine	
	Utility #36	Utility #25	Utility #36	Utility #7	Utility #36
Total Trihalomethanes	decrease	decrease	no change	decrease	decrease
Total Haloacetic Acids	decrease	decrease	no change	decrease	decrease
Total Haloacetonitriles	decrease	no change	no change	decrease	decrease
Total Haloketones	decrease	no change	increase	decrease	decrease
Total Aldehydes	decrease	increase	increase	not analyzed	increase
Chloropicrin	increase	increase	increase	decrease	increase
Chloral Hydrate	decrease	decrease	increase	decrease	decrease
Cyanogen Chloride	increase	increase	increase	no change	increase

Notes: Results based on full scale evaluation at Utilities #19 and #25 and on pilot scale evaluations at Utilities #7 and #36.

Free chlorine contact time was 4 hours for Utility #7 during use of chlorine/chloramine strategy.

Systems must demonstrate efficacy of chloramines as a primary disinfectant if they are to be used as such.

Source: USEPA, 1992; Jacangelo, et al., 1989.

### 9.1.3 Chlorine/Chlorine to Chlorine/Chloramine

Chloramines as a secondary disinfectant shortens the free chlorine contact time and, therefore, reduce the formation of most halogenated DBPs, including TTHM. However, the consumer is exposed to a chloramine residual that has a different health concern (i.e., can cause methemoglobinemia and adversely affect the health of kidney dialysis patients) than chlorine residual. For maximum benefit in reducing halogenated byproducts, the ammonia/chlorine mixing conditions should be optimized to quickly remove free chlorine from the system, with the optimal pH for the chlorine/ammonia reaction considered to be pH 8.3. In one case, changing the secondary disinfectant from chlorine to chloramines resulted in a reduction in average TTHM concentrations from 105 µg/L to 45 µg/L with most (80 percent) of the TTHM formation in the chloraminated system occurring prior to the addition of ammonia (Singer, 1988).

### 9.1.4 Chlorine/Chlorine to Ozone/Chlorine

A change from chlorine to ozone for primary disinfection is attractive because ozone generally produces fewer regulated DBPs than chlorine. However, as mentioned in previous chapters, ozone will react with organic compounds to produce BOM, aldehydes, organic acids, and ketones, many of which are biodegradable. In addition, for water sources containing significant bromide ion concentrations, site-specific engineering evaluations should be completed prior to using ozone as a primary disinfectant due to the potential formation of bromate ion or brominated organic byproducts. At low pH values, the brominated organic byproducts are favored, while at higher pH values, bromate ion formation is favored. Therefore, changing from chlorine to ozone may be limited in cases where the source water contains bromide ion. In the ozone/chlorine strategy, bromine has the opportunity to react with NOM prior to chlorine application, potentially increasing the extent of bromine incorporation into DBPs. Also, in this situation, switching to biological filtration can increase regrowth and corrosion rates in the distribution system.

In systems containing negligible concentrations of bromide ion, replacement of pre-chlorination with ozonation may allow for the point of chlorine addition to be moved beyond clarification or filtration. The principal benefit derived from using ozone for controlling THM formation is that it allows free chlorine to be applied later in the treatment process after precursors have been removed. This would be expected to result in reduced formation of chlorinated DBPs due to the reduced chlorine dose requirement and the reduced NOM concentrations following treatment. Replacement of chlorine with ozone appears to be most effective in decreasing chlorinated DBPs when it eliminates the need for pre-chlorination. However, replacing chlorine with ozone while maintaining free chlorine as a secondary disinfectant has produced mixed results, with some byproduct concentrations being reduced at the expense of increasing the concentrations of others. *The human health implications of this trade-off are largely unknown.* It has been shown that substituting ozone for chlorine as a primary disinfectant, while maintaining free chlorine as a secondary disinfectant when not practicing pre-chlorination, resulted in an increased THM formation in raw waters for the Cities of Phoenix and San Diego (Malcolm Pirnie, 1989; Malcolm Pirnie, 1990).

An operational consideration of the ozone/chlorine system is the application point for chlorine. The ozone should be completely decomposed or chemically quenched prior to chlorine addition. If ozone is present when chlorine is added, the ozone will react with the chlorine and NOM present to form chlorinated DBPs.

Ozonation converts NOM into low molecular weight humic NOM and may increase the concentrations of precursors to some DBPs. For instance, ozonation followed by chlorination as a secondary disinfectant may yield high concentrations of chloral hydrate (Logsdon et al., 1992; McKnight and Reckhow, 1992). This may occur because the byproduct of ozonation, acetaldehyde, is a known precursor for chloral hydrate, a byproduct of chlorination. Enhancement of chloral hydrate has not been observed when biologically active filtration is used following ozonation and prior to chlorination (Singer, 1992). In addition to chloral hydrate, ozonation followed by chlorination can produce greater THM and halo ketones levels than chlorination alone, particularly when chlorine is applied at high pH levels (Jacangelo et al., 1989; Reckhow et al., 1986). Ozonation followed by chlorination or chloramination can increase chloropicrin and cyanogen chloride concentrations above those observed with chlorination or chloramination alone (Jacangelo et al., 1989). The most promising treatment strategy for preventing the enhancement of these biodegradable ozonation byproducts and BOM is to locate ozonation after sedimentation and follow it by biologically active GAC.

### 9.1.5 Chlorine/Chlorine to Ozone/Chloramine

In addition to the concerns addressed in Sections 9.1.3 and 9.1.4, switching from chlorine to chloramine residual exposes the consumer to a residual that may be a more significant health concern (particularly for kidney dialysis patients). The impact of switching from chlorine/chlorine to ozone/chloramines on the production of byproducts was investigated in a 5 gpm pilot study (MWDSC and JMM, 1989; Jacangelo et al., 1989). That switch produced greater concentrations of chloropicrin, cyanogen chloride, formaldehyde and total aldehydes than in the original chlorine/chlorine strategy. Concentrations of TTHMs, total haloacetic acids, total haloacetonitriles, total halo ketones and chloral hydrate were lower with ozone/chloramine. Brominated DBPs were not reported. Ozonation followed by chloramination has been observed to increase cyanogen chloride concentrations beyond those observed with chlorination only (Jacangelo et al., 1989). Increased chloral hydrate has not been observed when monochloramine is applied as the secondary disinfectant (Singer, 1992).

### 9.1.6 Chlorine/Chlorine to Chlorine Dioxide/Chlorine

Use of chlorine dioxide as a pre-oxidant to replace chlorine may allow moving the point of chlorination downstream in the process train for application to water with lower NOM concentrations. The reduced precursor concentration and the reduced chlorine dose should result in a reduction of chlorinated DBPs. However, if excess chlorine is present in the chlorine dioxide feed stream, it would react with NOM prior to removal in sedimentation and filtration if pre-oxidation is practiced. Switching from chlorine/chlorine to chlorine dioxide/chlorine produces mixed results.

Like ozone, chlorine dioxide alters the nature of NOM molecules, potentially forming greater precursor concentrations for some DBPs while reducing the precursor concentrations for other DBPs. *The human health implications of these trade-offs are largely unknown.* Chlorine dioxide/chlorine appears to be most effective in decreasing chlorinated DBPs when it can replace the need for pre-chlorination. However, for facilities that use pre-chlorination but do not require it, continuing to use chlorine/chlorine while eliminating pre-chlorination may be as effective in decreasing chlorinated DBPs.

### 9.1.7 Chlorine/Chlorine to Chlorine Dioxide/Chlorine Dioxide

The potential to apply chlorine dioxide as both a primary and secondary disinfectant is limited because:

- Chlorine dioxide is a strong oxidant and dissipates rapidly in both raw and treated waters; and
- Approximately 50 to 70 percent of chlorine dioxide is converted to the inorganic byproducts chlorite and chlorate.

On the positive side, chlorine dioxide/chlorine dioxide application will significantly lower the formation of organic DBPs.

### 9.1.8 Chlorine/Chloramine to Ozone/Chloramine

In addition to the concerns raised in Sections 9.1.4 and 9.1.5, switching from chlorine/chloramine to ozone/chloramine resulted in reduced formation of most of the halogenated DBPs (MWDSC and JMM, 1989). Other studies also indicate reduction in the formation of most halogenated DBPs but increased formation of 1,1-dichloropropanone (MWDSC and JMM, 1989). The primary difference in chlorinated DBP formation when switching from chlorine/chloramine to ozone/chloramine could be attributed to the shorter contact time with free chlorine.

### 9.1.9 Chlorine/Chloramine to Chlorine Dioxide/Chloramine

The Louisville Water Company evaluated the feasibility of switching from a chlorine/chloramine to chlorine dioxide followed by chloramine to control THM formation (Hubbs et al., 1981). The treatment plant includes lime soda-ash for softening. Disinfection occurs prior to the lime treatment step. Ammonia is added to form chloramine before the water enters the softening phase. There is a 10 minute lag period between the first disinfectant (chlorine or chlorine dioxide) and second disinfectant (chloramine) addition. The study showed a significant decrease in THM formation from 25 µg/L with chlorine to 5 µg/L using chlorine dioxide as the initial disinfectant. At the same time, treated water coliform densities were essentially unchanged; however, results showed slightly more scattered data during the chlorine dioxide test period. Based on these results, the Water Company decided to use chlorine/chloramine to meet disinfection and THM targets. No other DBPs were measured during the test period.

### 9.1.10 Ozone/Chlorine to Ozone/Chloramine

In addition to concerns raised in Sections 9.1.4 and 9.1.5, when compared with ozone/chlorine, ozone/chloramine produced greater concentrations of cyanogen chloride. Concentrations of TTHM, total haloacetic acids, total haloacetonitriles, total haloketones, chloral hydrate, total aldehydes and formaldehyde were lower with ozone/chloramine than with ozone/chlorine. Ozone/chloramine produces some chlorinated DBPs at greater concentrations than ozone/chlorine; however, ozone/chloramine significantly reduces TTHMs compared to ozone/chlorine (LeLacheur et al., 1991).

### 9.1.11 Summary

EPA is not encouraging systems to switch to different disinfectants due to unknown risks to public health. When needed for compliance with regulations or increasing *Cryptosporidium* inactivation, careful selection of alternative disinfectants as primary and secondary disinfectants, can produce less DBPs and increase inactivation. In general, the results followed the characteristic DBPs associated with the primary disinfectant (halogenated DBPs with chlorine compounds or ozone in the presence of bromide oxidized organics, AOC with ozone or peroxone). However, by carefully selecting the primary and secondary disinfectant and avoiding long contact times and high dosages of halogens (chlorine, bromine), the total DBP formation declined. The quantity and types of DBPs that form are site-specific, depending on the water quality, disinfectant dose and type, and are best determined by bench testing. Note that any system changing disinfectants is subject to the profiling and benchmarking requirements as described in Section 1.3.1 and specified in 40 CFR § 141.172.

## 9.2 Pathogen Inactivation with Interactive Disinfectants

In 1988, several reports appeared on the combined efficiency of some disinfectants on pathogen inactivation. Worley and Williams (1988) reported that a mixture of free chlorine and organic *N*-halamine produced higher levels of inactivation of a variety of bacteria. The combination of free chlorine and sodium bromide was also investigated and found to be more effective than using free chlorine alone (Alleman et al., 1988). In a study at the University of Arizona, the synergistic inactivation of *E. coli* and MS-2 coliphage was demonstrated by the combined application of chloramine and cupric chloride (Straub et al., 1994).

Recently there has been a great deal of interest in the potential of interactive disinfectants because reports showed that some of these combinations are more effective for inactivating *Cryptosporidium* (Finch et al., 1994). Research on interactive disinfectants for primary pathogen inactivation is under way for several combinations of disinfectants:

- Chlorine followed by chloramine;
- Chlorine dioxide followed by chlorine;
- Chlorine dioxide followed by chlorine dioxide;

- Chlorine dioxide followed by chloramine;
- Ozone followed by chlorine;
- Ozone followed by chlorine dioxide; and
- Ozone followed by chloramine.

### 9.2.1 Inactivation Mechanism

Bernbaum (1981 and 1985) developed a testing method for determining the kind of interaction that can be expected when agents are combined to produce a given observation. Synergism can be tested using the mathematical model developed by Bernbaum and modified for disinfection kinetics by Kouame and Haas (1991). The principle is that, if the agents in a given combination do not interact in producing the effect observed, then regardless of the effect relations, the following equation is satisfied:

$$\sum_{i=1}^n \frac{x_i}{y_i} = 1$$

where:

- $x_i$  = Concentration of the individual agent in the combination
- $y_i$  = Concentration of the agents that individually would produce the same magnitude of effect as that of the combination
- $i$  = Individual agent
- $n$  = Total number of agents

The sum calculated from this equation for a set of data is interpreted as follows:

- The sum is less than 1 in the case of synergistic interaction;
- The sum is greater than 1 in the case of antagonistic interaction; and
- The sum is equal to 1 in the case of additivity (zero interaction).

Using this approach, Kouame and Haas (1991) showed that a synergistic interaction exists in the inactivation of *E. coli* when exposed simultaneously to free chlorine and monochloramine.

The authors described a possible mechanism in which both of the disinfectants work together to inactivate bacteria. The researchers hypothesized that bacterial inactivation is caused by monochloramine penetrating the cell and oxidizing thiol groups, which in turn causes structural changes in the cell membrane. Once these changes have been made, copper is allowed to pass into the cell and binds either to sulfhydryl groups of respiratory enzymes or nucleic acids. More recently, the researchers investigating *E. coli* inactivation hypothesized that a potential synergistic mechanism consisting of sub-lethal injury caused by free chlorine resulted in enhanced sensitivity to monochloramine (Kouame and Haas, 1991).

Another hypothesis for the increased effectiveness of interactive disinfectants is that the first oxidant (i.e., chlorine, chlorine dioxide, or ozone) conditions the outer membrane of *Cryptosporidium* oocysts so that the secondary oxidant (i.e., chlorine, chlorine dioxide, and monochloramine) can penetrate the oocyst more easily (Liyanage et al., 1996). For example, preliminary work on the disinfection of *Cryptosporidium parvum* using free chlorine followed by monochloramine suggested that there may be a synergism involving two chlorine species. Sequential treatment of these chlorine species was found to provide greater inactivation than expected from the additive effects of the two disinfectants used alone (Gyurek et al., 1996).

Recent studies have utilized a straight forward method to determine if synergism has occurred based on measured inactivation (Finch, 1997; Gyurek et al., 1996; and Liyanage et al., 1996). According to this approach, synergism is demonstrated if the sequential application of disinfectants provides more inactivation than is expected from the additive effects of the individual, separate disinfectants. In addition, the magnitude of the synergistic effects is equal to the difference in the level of inactivation achieved from multiple disinfectants and the additive inactivations achieved from the single disinfectants.

## 9.2.2 Environmental Effects

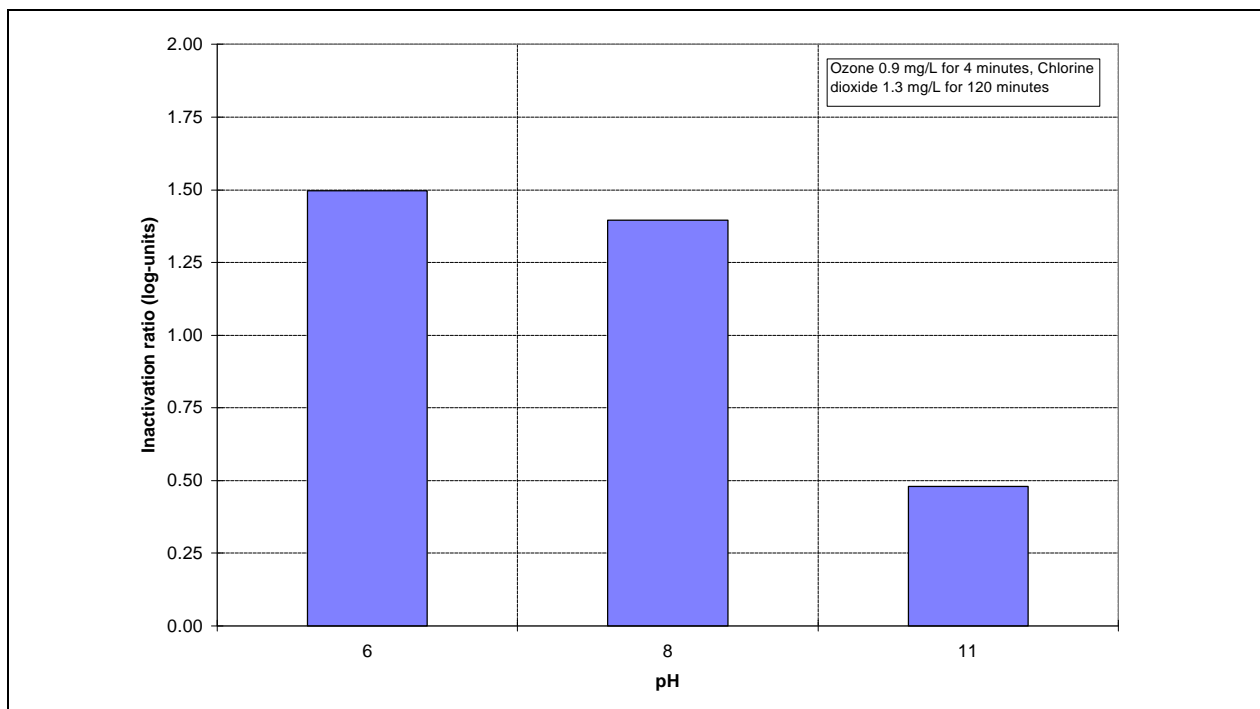
Similar to most chemical disinfectants, the preliminary results from an AWWARF ongoing study suggest that pH and temperature affect the amount of synergistic inactivation achieved by sequential applications of disinfectants (Finch, 1997). The following sections briefly describe the effects these parameters have on pathogen inactivation.

### 9.2.2.1 pH

The level of inactivation due to the sequential application of chemical disinfectants is believed to be pH dependent (Finch, 1997). Figure 9-1, Figure 9-2, and Figure 9-3 illustrate the impact of pH on the log inactivation of *Cryptosporidium parvum* attributed to synergistic effects for three sequential combinations of ozone-chlorine dioxide, chlorine dioxide-free chlorine, and chlorine dioxide-chloramine, respectively. As shown in these figures, the amount of log inactivation due to synergistic effects is lower at high pH (e.g., pH = 11). These results show that neutral pH is more effective than low pH except for ozone-chlorine dioxide.

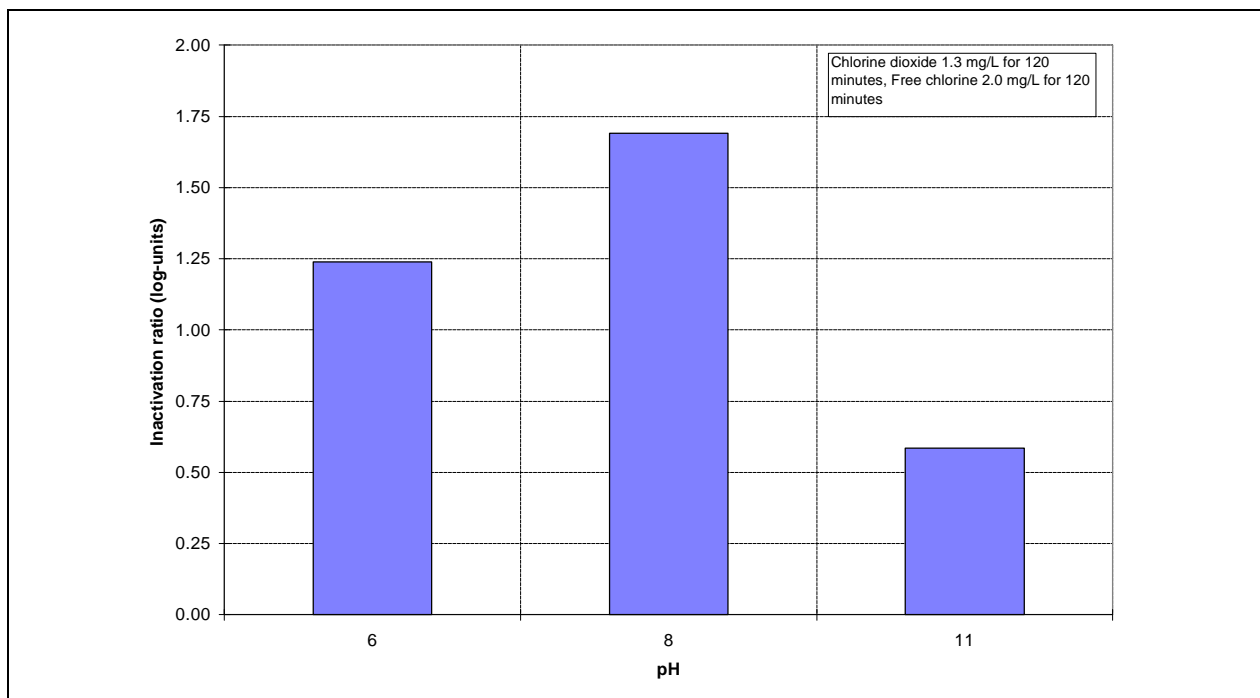
### 9.2.2.2 Combination of Low Temperature and pH

The combined effect of low temperature and high pH is believed to significantly reduce the amount of *Cryptosporidium* inactivation attributed to synergism (Finch, 1997). One possible explanation for this reduction is that the oocysts contract under these conditions and become harder to penetrate. However, significant reduction in *Cryptosporidium* oocysts inactivation is true under reduced water temperature and high pH whether interactive disinfection is practiced or not. Therefore, reduced inactivation may not be necessarily due to synergism between combined disinfectants.



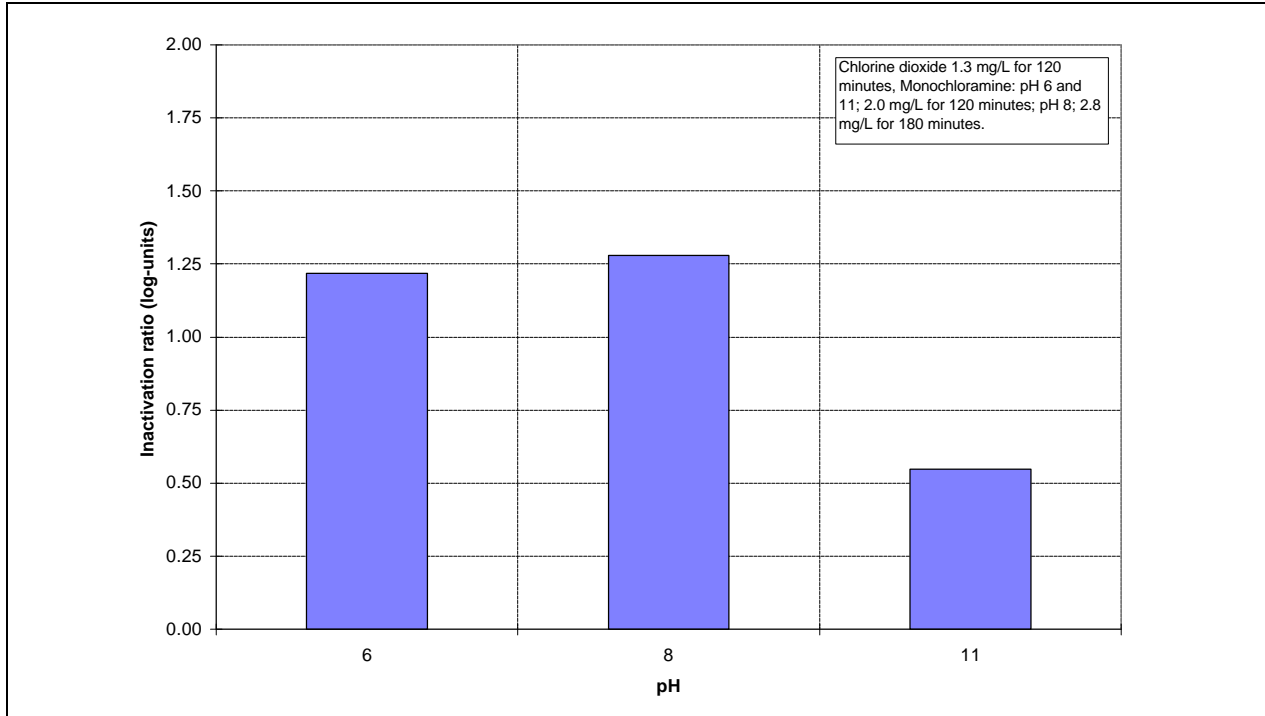
Source: Finch, 1997.

**Figure 9-1. Inactivation of *C. parvum* Attributed to Synergistic Effects. Application of Ozone Followed by Chlorine Dioxide**



Source: Finch, 1997.

**Figure 9-2. Inactivation of *C. parvum* Attributed to Synergistic Effects. Application of Chlorine Dioxide Followed by Free Chlorine**



Source: Finch, 1997.

**Figure 9-3. Inactivation of *C. parvum* Attributed to Synergistic Effects. Application of Chlorine Dioxide Followed by Monochloramine**

### 9.2.2.3 Pathogen Susceptibility

*Cryptosporidium* oocysts are more susceptible to inactivation by combinations of disinfectants than by individual disinfectants. *Giardia* cysts were also found to have a similar response to:

- Ozone followed by free chlorine;
- Ozone followed by monochloramine;
- Chlorine dioxide followed by free chlorine;
- Chlorine dioxide followed by monochloramine; and
- Free chlorine followed by monochloramine.

However, no synergism was observed with bacterial spores, specifically *Bacillus cereus* spores (Finch, 1997). These results suggest that encysted parasites might show more susceptibility to synergistic effects than bacterial spores. Masking effects caused by turbidity for interactive disinfectants are expected to be similar to those of the individual disinfectants.

### 9.2.3 Pathogen Inactivation Efficiency Using Interactive Disinfectants

Within the last few years there have been several studies to investigate interactive disinfectants. These studies were conducted under various conditions of pH, bench or laboratory scale, and using various organisms:

- Battigelli and Sobsey (1993) studied viral inactivation under lime softening conditions using sequential addition of chlorine and monochloramine;
- Kouame and Haas (1991) determined *E. coli* inactivation during simultaneous addition of free chlorine and monochloramine;
- Finch (1997) is studying various combinations of chlorine, chlorine dioxide, ozone, and monochloramine on inactivation of *Cryptosporidium parvum* oocysts, *Giardia muris* cysts, and *Bacillus cereus* spores under laboratory conditions; and
- Oppenheimer (1997) is developing CT requirements for *Cryptosporidium parvum* inactivation in a variety of natural waters using ozone followed by chlorine.

The following is a summary of the findings of these studies to date.

#### 9.2.3.1 Virus Inactivation Using Chlorine and Monochloramine Under High pH

One of the primary objectives of the Battigelli and Sobsey study (1993) was to evaluate the disinfection efficiency under high pH conditions encountered in conventional lime softening treatment with and without the addition of chlorine and monochloramine. The three microorganisms selected for evaluation were hepatitis A virus, poliovirus 1, and MS-2 coliphage.

During the study, the inactivation kinetics of the three test viruses were determined when 2.0 mg/L monochloramine were formed dynamically after the viruses had been exposed to lime solution and free chlorine for 60 seconds. The authors believed that this approach simulates the conditions typically encountered in a water softening facility where ammonia is applied post-chlorination.

Results indicated that a high degree of inactivation occurs during the first 60 seconds of chlorine addition at approximately 2.4 mg/L free chlorine.

Table 9-6 shows the amount of inactivation attributed to the lime solution, free chlorine, and monochloramine for the three viruses. The table also contains the amount of inactivation attributed to the sequential application of lime solution, free chlorine and monochloramine previously described (simultaneous chloramination). Results shown in Table 9-6 are based on a pH of 11.0 and a total contact time of 360 minutes.

Except for poliovirus 1, the summation of the individual disinfectants was greater than the level of inactivation achieved from the simultaneous chloramination. These results imply that the sequential addition of free chlorine and monochloramine after lime addition to raise the pH to 11, form an

antagonistic (negative) interaction for inactivation of hepatitis A virus and MS-2 coliphage. For poliovirus 1, under similar conditions, an enhancement of 1.4 log inactivation was achieved suggesting positive synergism for poliovirus 1 inactivation.

**Table 9-6. Virus Inactivation By Individual Disinfectants and Simultaneous Chloramination**

Disinfectant(s)	Log Survival <sup>1</sup>			Condition
	Hepatitis A Virus	Poliovirus	MS-2 Coliphage	
Lime solution only	-3.0	-0.5	-4.0	360 min contact time
Free chlorine	-1.8	-1.2	-1.6	60 second contact time, 2.5 mg/L chlorine
Monochloramine	-3.7	-1.9	-3.8	2.0 mg/L monochloramine
Summation free+monochloramine	-5.5	-3.1	-5.4	Additive
Simultaneous chloramination	-4.5	-4.5	-4.5	2.4 mg/L chlorine 60 second contact time, 2.0 mg/L monochloramine, 359 minutes.

<sup>1</sup> All data at pH 11 after lime addition  
Source: Battigelli and Sobsey, 1993.

### 9.2.3.2 Inactivation of *E. coli* Under Simultaneous Free and Combined Chlorination

The inactivation of *E. coli* bacteria by the simultaneous application of free chlorine and monochloramine was investigated at the Illinois Institute of Technology (Kouame and Haas, 1991). Figure 9-4 shows the level of *E. coli* inactivation by free chlorine and monochloramine, separately and combined. The level of inactivation by monochloramine alone after a contact time of 300 seconds was found to be significantly less than that of free chlorine. Therefore, the sum of the individual inactivation by free chlorine and monochloramine was assumed to be equal to that of free chlorine alone. Note that in this case, the residual disinfectant rapidly disappeared due to the breakpoint reactions that occur when monochloramine and free chlorine are combined.

The surviving fraction of bacteria following the simultaneous application of free chlorine and monochloramine is substantially less than what would be expected by adding the individual levels of inactivation. In other words, at similar doses and contact times, the amount of inactivation from the combined disinfectants was greater than the sum of the inactivation due to free chlorine alone and monochloramine alone.

In summary the Kouame and Haas (1991) study showed that high levels of bacteria inactivation can be achieved when free chlorine and monochloramine exist simultaneously in a continuous flow system and that the combined action of both chemicals on the bacteria is synergistic.

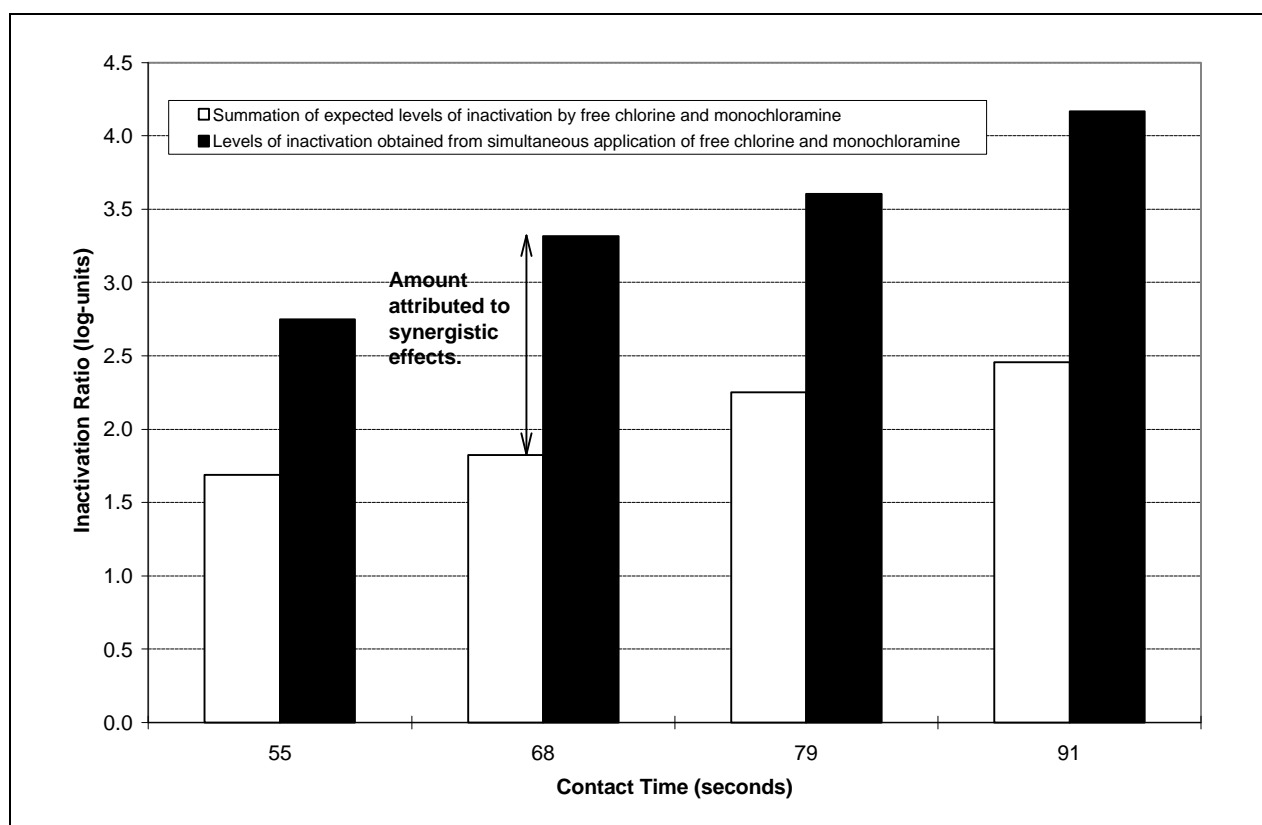
### 9.2.3.3 *Cryptosporidium*, *Giardia*, and *Bacillus* Inactivation in Laboratory Grade Water

The preliminary results of an AWWARF study that investigated the application of multiple disinfectants was presented at a American Water Works Association Technology Transfer Conference in Portland, OR, in August 1997. The objectives of this study were to screen interactive chemical disinfectants (ozone, chlorine, chlorine dioxide, and monochloramine) for inactivation of *Cryptosporidium parvum*, *Giardia muris*, and *Bacillus cereus* and develop design criteria for *Cryptosporidium parvum* inactivation using the best combinations.

#### Ozone Followed By Chlorine Dioxide

Table 9-7 shows the results obtained from ozone and chlorine dioxide application for the inactivation of *Cryptosporidium parvum*.

Based on the data shown in Table 9-7, ozone followed by chlorine dioxide was the most effective disinfectant combination for *Cryptosporidium* inactivation. A total contact time of 124 minutes was required to achieve 3 to 4-log inactivation with ozone and chlorine dioxide residuals of 0.9 and 1.3 mg/L, respectively.



Source: Kouame and Haas, 1991.

**Figure 9-4. Inactivation of *E. coli* Using Free Chlorine and Monochloramine**

**Table 9-7. *C. parvum* Inactivation Using Ozone Followed by Chlorine Dioxide**

Disinfectant	Level of Inactivation (log-units)		
	pH 6.0	pH 8.0	pH 11.0
Ozone	1.6	0.8	0
Chlorine dioxide	0.9	1.4	2.4
Ozone followed by chlorine dioxide	4.0	3.6	2.9
Inactivation attributed to synergism	1.5	1.4	0.5

Source: Finch, 1997.

Ozone: 0.9 mg/L for 4 minutes, chlorine dioxide 1.3 mg/L for 120 minutes.

### Chlorine Dioxide Followed by Free Chlorine

Table 9-8 through Table 9-10 summarize of the results obtained for chlorine dioxide followed by free chlorine for *Cryptosporidium parvum*, *Giardia muris*, and *Bacillus cereus*, respectively.

**Table 9-8. *C. parvum* Inactivation Using Chlorine Dioxide Followed by Free Chlorine**

Disinfectant	Level of Inactivation (log-units)		
	pH 6.0	pH 8.0	pH 11.0
Chlorine dioxide	1.0	1.4	1.6
Free chlorine	0	0	0
Chlorine dioxide followed by free chlorine	2.2	3.0	2.3
Inactivation attributed to synergism	1.2	1.6	0.7

Source: Finch, 1997.

Chlorine dioxide 1.3 mg/L for 120 minutes, free chlorine 2.0 mg/L for 120 minutes.

**Table 9-9. *G. muris* Inactivation Using Chlorine Dioxide Followed by Free Chlorine**

Disinfectant	Level of Inactivation (log-units)	
	pH 6.0	pH 8.0
Chlorine dioxide	0.8	0.8
Free chlorine	0.8	0.6
Chlorine dioxide followed by free chlorine	2.2	2.0
Inactivation attributed to synergism	0.6	0.6

Source: Finch, 1997.

Chlorine dioxide: 1.0 mg/L for 10 minutes, free chlorine 2.0 mg/L for 30 minutes.

**Table 9-10. *B. cereus* Inactivation Using Chlorine Dioxide Followed by Free Chlorine**

Disinfectant	Level of Inactivation (log-units)	
	pH 6.0	pH 8.0
Chlorine dioxide	1.8	
Free chlorine	1.2	
Chlorine dioxide followed by free chlorine	2.9	
Inactivation attributed to synergism	0	

Source: Finch, 1997.

Chlorine dioxide: 2.3 mg/L for 20 minutes, free chlorine for 30 minutes.

Chlorine dioxide followed by free chlorine was capable of achieving between 2 and 3 logs of *Cryptosporidium* inactivation following a total contact time of 240 minutes and approximately 2 logs of inactivation of *Giardia* following only 40 minutes of contact time. No synergism was observed with *Bacillus cereus*. However, approximately 3 logs of inactivation after a contact time of 50 minutes were achieved by the additive effects of chlorine dioxide and free chlorine.

### Chlorine Dioxide Followed by Chloramine

Table 9-11 and Table 9-12 show the results of the inactivation of *Cryptosporidium parvum* and *Giardia muris* when using chlorine dioxide followed by monochloramine.

**Table 9-11. *C. parvum* Inactivation Using Chlorine Dioxide Followed by Chloramine**

Disinfectant	Level of Inactivation (log-units)		
	pH 6.0	pH 8.0	pH 11.0
Chlorine dioxide	1.0	1.5	1.6
Monochloramine	0	0	0
Chlorine dioxide followed by monochloramine	2.2	2.8	2.1
Inactivation attributed to synergism	1.2	1.3	0.5

Source: Finch, 1997.

Chlorine dioxide: pH 6, 8, and 11: 1.3 mg/L for 120 minutes. Monochloramine: pH 6 and 11: 2.0 mg/L for 120 minutes, pH 8: 2.8 mg/L for 180 minutes.

**Table 9-12. *G. muris* Inactivation Using Chlorine Dioxide Followed by Chloramine**

Disinfectant	Level of Inactivation (log-units)	
	pH 8.0	pH 11.0
Chlorine dioxide	0.8	0.8
Monochloramine	0.5	0.7
Chlorine dioxide followed by monochloramine	1.7	1.5
Inactivation attributed to synergism	0.4	0

Source: Finch, 1997.

pH 8.0: Chlorine dioxide 1.0 mg/L for 5 minutes, monochloramine 2.0 mg/L for 150 minutes.

pH 11.0: Chlorine dioxide 1.0 mg/L for 5 minutes, monochloramine 2.0 mg/L for 5 minutes.

At similar disinfect residuals and contact times, chlorine dioxide followed by monochloramine was found to achieve the same levels of *Cryptosporidium* inactivation as chlorine dioxide followed by free chlorine at pH values of 6 and 11. However, at pH 8, a higher monochloramine residual and contact time were required to achieve inactivation levels comparable to chlorine dioxide and free chlorine. No synergism was found for *Giardia* inactivation at pH 11.0 with only a minimal increase in effectiveness at pH 8.0.

### Ozone Followed by Free Chlorine

Table 9-13 and Table 9-14 show the levels of inactivation of *Giardia muris* and *Bacillus cereus* obtained by using ozone followed by free chlorine.

**Table 9-13. *G. muris* Inactivation Using Ozone Followed by Free Chlorine**

Disinfectant	Level of Inactivation (log-units)		
	pH 6.0	pH 8.0	pH 11.0
Ozone	0.5	0.8	0.4
Free chlorine	0.8	0.6	0
Ozone followed by free chlorine	2.3	2.2	0.4
Inactivation attributed to synergism	1.0	0.8	0

Source: Finch, 1997.

pH 6.0: ozone 0.1 mg/L for 60 seconds; free chlorine 2.0 mg/L for 30 minutes.

pH 8.0: ozone 0.1 mg/L for 17 seconds; free chlorine 2.0 mg/L for 60 minutes.

pH 11.0: ozone 0.1 mg/L for 5 seconds; free chlorine 2.0 mg/L for 60 minutes.

**Table 9-14. *B. cereus* Inactivation Using Chlorine Dioxide Followed by Free Chlorine**

Disinfectant	Level of Inactivation (log-units)	
	pH 6.0	pH 11.0
Chlorine dioxide	1.4	
Free chlorine	2.0	
Chlorine dioxide followed by free chlorine	3.4	
Inactivation attributed to synergism	0	

Source: Finch, 1997.

Ozone followed by free chlorine was capable of achieving approximately 2 logs of *Cryptosporidium* inactivation at pH 6.0 and 8.0; however, only a 0.4 log inactivation was achieved at pH 11.0. The difference in inactivations was primarily caused by the inability of free chlorine to inactivate *Cryptosporidium* at pH 11.0. Similar to the disinfectant combination of chlorine dioxide and free chlorine, no synergism was observed for *Bacillus cereus* inactivation; however, the additive effects of ozone and free chlorine achieved greater than 3 logs of inactivation.

### Ozone Followed by Monochloramine

Table 9-15 shows the results obtained for *Giardia muris* inactivation by ozone followed by monochloramine.

**Table 9-15. *G. muris* Inactivation Using Ozone Followed by Chloramine**

Disinfectant	Level of Inactivation (log-units)	
	pH 8.0	pH 11.0
Ozone	0.8	0.4
Monochloramine	0.5	0.7
Ozone followed by monochloramine	2.1	1.8
Inactivation attributed to synergism	0.8	0.7

Source: Finch, 1997.

pH 8.0: ozone 0.1 mg/L for 17 seconds; monochloramine 2.0 mg/L for 150 minutes.

pH 11.0: ozone 0.1 mg/L for 5 seconds; monochloramine 2.0 mg/L for 5 minutes.

Because of the different residuals and contact times, inactivation efficiencies of ozone followed by chloramine and ozone followed by free chlorine could not be compared. However, for similar

monochloramine residuals, a very short monochloramine contact time of 5 minutes at pH 11 was found to achieve a greater inactivation than a contact time of 150 minutes at pH 8.

### Free Chlorine Followed by Monochloramine

Table 9-16 shows the results obtained for *Giardia muris* inactivation by free chlorine followed by monochloramine.

Similar to the results obtained for ozone followed by monochloramine, a very short monochloramine contact time of 5 minutes at pH 11 was found to achieve a greater inactivation than a contact time of 150 minutes at pH 8. However, free chlorine did not achieve any inactivation at pH 11.

**Table 9-16. *G. muris* Inactivation by Free Chlorine Followed by Monochloramine**

Disinfectant	Level of Inactivation (log-units)	
	pH 8.0	pH 11.0
Free chlorine	0.6	0
Monochloramine	0.5	0.7
Free chlorine followed by monochloramine	2.4	0.7
Inactivation attributed to synergism	1.3	0

Source : Finch, 1997.

pH 8.0: free chlorine 2.0 mg/L for 60 minutes; monochloramine 2.0 mg/L for 150 minutes.

pH 11.0: free chlorine 2.0 mg/L for 60 minutes, monochloramine 2.0 mg/L for 5 minutes.

### 9.2.3.4 Bench-Scale Tests Using Natural Waters

In another AWWARF study, Oppenheimer (1997) is developing CT requirements for *Cryptosporidium parvum* inactivation in a variety of natural waters, developing design criteria for full-scale contacting systems from bench scale CT values, and investigating the impact of selected variables on CT requirements. To date, samples have been collected and analyzed from 13 geographically disperse locations. Although a significant amount of data were not available, results from the California State Water Project and Ohio River appear to show that the sequential application of ozone and chloramines resulted in an enhanced inactivation of *C. parvum* as shown in Table 9-17. The sequential application of free chlorine and monochloramine appears to enhance *C. parvum* inactivation by providing some synergistic effects. To obtain the log reduction, however, very high ozone residuals were required which appear to be impractical. In addition, bromate formation was also a problem.

**Table 9-17. *C. parvum* Inactivation by Sequential Application of Ozone and Chloramine**

Water Source	Ozone		Chlorine		Chloramine		Log Inactivation Enhancement
	Residual mg/L	Contact min	Residual mg/L	Contact min	Residual mg/L	Contact min	
California State Water Project	0.8	12	1.5	~0	2.5	30	0.3 to > 1.4
Ohio River	4	15	1.5	120	0.5	120	0.9 to 1.4

Source: Oppenheimer, 1997.

## 9.2.4 Summary: Pathogen Inactivation with Interactive Disinfectants

Various studies have shown the synergistic effects of interactive disinfectants: either simultaneous application or sequential application. The improved disinfection efficiency due to interactive disinfection is variable, ranging from negative (antagonistic) effects (in two studies) to positive enhancement of disinfection efficiency. Many of the studies show definite improvement in inactivation for interactive disinfectants.

Several research projects on the effects of combined disinfectants are underway at the time this manual is being prepared. These projects should provide insight on the mechanisms and applicability of multiple disinfectants. Based on current information, EPA believes that under appropriate situations a positive improvement in disinfection efficiency exists. This enhanced inactivation varies from organism to organism, and with different disinfectant combinations. For the key organisms of interest under normal pH conditions:

- Coliform bacteria inactivation appears to increase with combined disinfectants;
- *Giardia* cyst inactivation appears to increase with combined disinfectants;
- Hepatitis A virus and MS<sup>-2</sup> coliphage inactivation using combined disinfectants appears to be less efficient than the individual disinfectants;
- Poliovirus 1 inactivation appears to increase with combined disinfectants;
- *Cryptosporidium* oocyst inactivation appears to increase with combined disinfectants; and
- Inactivation of spores appears neutral.

Interactive disinfection is still however considered an emerging technology. As such, CT credits for interactive disinfectants have not yet been established.

## 9.3 Analytical Methods

In general, most of the analytical methods for residual disinfectants are impacted negatively by the presence of other disinfectants. Fortunately, for most of the disinfectants and oxidants listed below, at least one method exists that can be used successfully in the presence of other oxidizing agents. For analytical method details, see the individual disinfectant chapters.

### 9.3.1 Ozone

Residual ozone analysis cannot be performed in the presence of other oxidizing agents including chlorine, chloramine, and potassium permanganate. Typically, the ozone analytical methods exhibit interferences from chlorine, bromine, iodine, and manganese ions. The ACVK is the least susceptible to interference and can be used when manganese concentrations are less than 1 mg/L and free or combined chlorine concentrations are less than 10 mg/L (Gordon et al., 1992).

### **9.3.2 Chlorine Dioxide**

Some of the analytical methods for chlorine dioxide, chlorate, and chlorite cannot be performed in the presence of oxidizing agents. Amperometric and iodometric methods cannot be used in the presence of metal ions such as manganese. Analytical methods that can be used in the presence of other disinfectants and oxidants include UV spectrophotometric methods and ion chromatography (Gordon et al., 1992).

### **9.3.3 Potassium Permanganate**

The atomic adsorption method for permanganate analysis can be performed in the presence of any of the other disinfectants (Standard Methods, 1995).

### **9.3.4 Chloramine**

None of the colorimetric analytical methods for chloramine can be performed in the presence of oxidizing agents such as ozone or hydrogen peroxide. Analytical methods that can be used in the presence of other disinfectants and oxidants include the UV spectrophotometric method and the amperometric titration methods (Gordon et al., 1992).

### **9.3.5 Hydrogen Peroxide**

The analytical procedures for hydrogen peroxide in drinking water are all impacted by other oxidizing species such as ozone and chlorine (Gordon et al., 1992).

### **9.3.6 UV Radiation**

There are no known interferences from other disinfectants with the measurement of UV radiation (DeMers and Renner, 1992).

### **9.3.7 Summary of Analytical Methods**

Ozone analysis in the presence of chlorine is limited. However, these disinfectants are not commonly present simultaneously, especially with the rapid decomposition of ozone.

Hydrogen peroxide analysis is difficult in the presence of ozone and other oxidizing agents. However, when using peroxone, the ozone residual is the analyte used to meet disinfection requirements.

All of the other disinfectants and oxidizing agents can be selectively monitored in the presence of other disinfectants.

## 9.4 Summary

Table 9-18 summarizes, in general, the factors and uses of combined disinfectants. Specific considerations depend on the actual combination of disinfectants used.

**Table 9-18. Summary of Combined Disinfectants**

Consideration	Description
Generation	Generation depends on the type of chemicals used. Ozone, chlorine dioxide, and chloramines require on-site generation.
Primary uses	Two separate disinfectants can be used to provide primary and secondary disinfection. By separating the primary and secondary disinfection functions, the processes can be optimized for maximum inactivation and minimum DBP formation.  Interactive disinfection (using synergism between two disinfectants to enhance inactivation) can serve as a primary disinfectant.
Inactivation efficiency	The use of interactive disinfection as primary disinfectant for inactivation of <i>Giardia</i> , <i>Cryptosporidium</i> , and viruses are feasible. Interactive disinfection is typically more effective than the individual disinfectants.
Byproduct formation	DBP formation is in general reduced by using combined disinfectants. Specifically, continued use of chlorine in combination with other disinfectants can reduce DBP formation.
Limitations	Data on the inactivation efficiency of combined disinfectants are still being generated with much information coming from controlled laboratory studies. Additional information is still needed, specifically on full-scale implementation. Dual (primary/secondary) disinfection for DBP control is well established as a preferred treatment option.
Point of application	Applied for primary and secondary disinfection. Ozonation should occur after settling and prior to biofiltration.
Special considerations	The efficiency and application of combined disinfectants follow to a large extent the limitations and features of the individual disinfectant. The combined disinfectant is often a more effective disinfectant.

## 9.5 References

1. Alleman, J. E., et al. 1988. "Comparative evaluation of alternative halogen-based disinfection strategies." Conference proceedings, Industrial Waste Conference, forty-second edition.
2. Battigelli, D.A. and M.D. Sobsey. 1993. "The Inactivation of Hepatitis A Virus, Poliovirus and Coliphage MS2 By Lime Softening and Chlorine/Monochloramine Disinfection." Conference proceedings, AWWA Water Quality Technology Conference.
3. Bernbaum, C.M. 1981. "Criteria for Analyzing Interactions Between Biologically Active Agents." *Adv. Cancer Res.* 35:269.
4. Bernbaum, C.M. 1985. "The expected effect of a combination of agents: the general solution." *J. Theor. Biol.* 114:413.
5. DeMers, L.D. and R.C. Renner. 1992. *Alternative Disinfection Technologies for Small Drinking Water Systems*. AWWA and AWWARF, Denver, CO.
6. Finch, G.R. 1997. "Control of *Cryptosporidium* Through Chemical Disinfection: Current State-of-the-Art." AWWARF Technology Transfer Conference, Portland, Oregon.
7. Finch, G.R., E.K. Black, and L.L. Gyurek. 1994. "Ozone and Chlorine Inactivation of *Cryptosporidium*." Conference proceedings, Water Quality Technology Conference; San Francisco, CA.
8. Gordon, G., W.J. Cooper, R.G. Rice, and G.E. Pacey. 1992. *Disinfectant Residual Measurement Methods*. Second Edition, AWWARF and AWWA, Denver, CO.
9. Gyurek, L., L. Liyanage, M. Belosevic, and G. Finch. 1996. "Disinfection of *Cryptosporidium Parvum* Using Single and Sequential Application of Ozone and Chlorine Species." Conference proceedings, AWWA Water Quality Technology Conference, Boston, MA.
10. Hubbs, S., D. Amundsen, and P. Olthius. 1981. "Use of Chlorine Dioxide, Chloramines, and Short-Term Free Chlorination as Alternative Disinfectants." *J. AWWA.* 73(2):97-101.
11. Jacangelo, J.G., N.L. Patania, K.M. Reagan, E.M. Aieta, S.W. Krasner, and M.J. McGuire. 1989. "Impact of Ozonation on the Formation and Control of Disinfection Byproducts in Drinking Water." *J. AWWA.* 81(8):74.
12. Kouame, Y. and C.N. Haas. 1991. "Inactivation of E coli. by Combined Action of Free Chlorine and Monochloramine." *Water Res.* 25(9):1027.
13. LeLacheur, R.M., P.C. Singer, and M.J. Charles. 1991. "Disinfection Byproducts in New Jersey Drinking Waters." Conference proceedings, AWWA Annual Conference, Philadelphia, PA.

14. Liyanage, L., L. Gyurek, M. Belosevic, and G. Finch. 1996. "Effect of Chlorine Dioxide Preconditioning on Inactivation of *Cryptosporidium* by Free Chlorine and Monochloramine." Conference proceedings, AWWA Water Quality Technology Conference, Boston, MA.
15. Logsdon, G.S., S. Foellmi, and B. Long. 1992. Filtration Pilot Plant Studies for Greater Vancouver's Water Supply. Conference proceedings, AWWA Annual Conference, Toronto, Ontario.
16. Lykins, B.W., J.A. Goodrich, W.E. Koffskey, and M.H. Griese. 1991. "Controlling Disinfection Byproducts with Alternative Disinfectants." Conference proceedings, AWWA Annual Conference, Philadelphia, PA.
17. Malcolm Pirnie, Inc. 1990. "Task 1.3 - Water Quality Report." Prepared for the Public Utilities Department, City of San Diego.
18. Malcolm Pirnie, Inc. 1989. "Water Quality Master Plan." City of Phoenix Water and Wastewater Department.
19. McKnight, A. and D. Reckhow. 1992. "Reactions of Ozonation Byproducts with Chlorine and Chloramines." Conference proceedings, AWWA Annual Conference, Vancouver, British Columbia.
20. MWDC AND JMM (Metropolitan Water District of Southern California and James M Montgomery Consulting Engineers). 1989. *Disinfection Byproducts in United States Drinking Waters*. Volume I. EPA and Association of Metropolitan Water Agencies. Cincinnati, OH and Washington, D.C.
21. Oppenheimer, J.A. 1997. "*Cryptosporidium* Inactivation in Natural Waters." AWWARF Technology Transfer Conference, Portland, OR.
22. Reckhow, D., B. Legube, and P. Singer. 1986. "The Ozonation of Organic Halide Precursors: Effect of Bicarbonate." *Water Res.* 20(8):987-998.
23. Richardson, Susan D., Alfred D. Thurston, Timothy W. Collette, Kathleen Schenck Patterson, Benjamin W. Lykins, George Majetich, and Yung Zhang. 1994. Multispecial Identification of Chlorine Dioxide Disinfection Byproducts in Drinking Water. *Environ. Sci. Technol.* 28:4:592.
24. Singer, P.C. 1988. *Alternative Oxidant and Disinfectant Treatment Strategies for Controlling Trihalomethane Formation*. EPA Risk Reduction Engineering Laboratory, Cincinnati OH Rept. No. EPA/600/2-88/044.
25. Singer, P.C. 1992. *Formation and Characterization of Disinfection Byproducts*. Presented at the First International Conference on the Safety of Water Disinfection: Balancing Chemical and Microbial Risks.

26. Standard Methods. 1995. *Standard Methods for the Examination of Water and Wastewater, nineteenth edition*. Franson, M.H., Eaton, A.D., Clesceri, L.S., and Greenberg, A.E., (editors), American Public Health Association, AWWA, and Water Environment Federation, Washington D.C..
27. Straub, T. M., et al. 1994. "Synergistic Inactivation of Escherichia coli and MS-2 Coliphage by Chloramine and Cupric Chloride." Conference proceedings, AWWA Water Quality Technology Conference, San Francisco, CA.
28. USEPA (U.S. Environmental Protection Agency). 1992. *Technologies and Costs for Control of Disinfection Byproducts*. Prepared by Malcolm Pirnie, Inc. for the Office of Ground Water and Drinking Water, Report No. PB93-162998.
29. Worley, S.D. and D.E. Williams. 1988. "Disinfecting Water with a Mixture of Free Chlorine and Organic B-halamine." *J. AWWA*. 80(1):6

<b>9.</b>	<b>COMBINED DISINFECTANTS.....</b>	<b>9-1</b>
9.1	PRIMARY AND SECONDARY DISINFECTANTS .....	9-1
9.1.1	DBP Formation with Various Primary and Secondary Disinfectant Combinations .....	9-3
9.1.2	Impact of Modifying Disinfection Practices .....	9-6
9.1.3	Chlorine/Chlorine to Chlorine/Chloramine.....	9-8
9.1.4	Chlorine/Chlorine to Ozone/Chlorine.....	9-8
9.1.5	Chlorine/Chlorine to Ozone/Chloramine .....	9-9
9.1.6	Chlorine/Chlorine to Chlorine Dioxide/Chlorine .....	9-9
9.1.7	Chlorine/Chlorine to Chlorine Dioxide/Chlorine Dioxide .....	9-10
9.1.8	Chlorine/Chloramine to Ozone/Chloramine .....	9-10
9.1.9	Chlorine/Chloramine to Chlorine Dioxide/Chloramine .....	9-10
9.1.10	Ozone/Chlorine to Ozone/Chloramine .....	9-11
9.1.11	Summary.....	9-11
9.2	PATHOGEN INACTIVATION WITH INTERACTIVE DISINFECTANTS .....	9-11
9.2.1	Inactivation Mechanism.....	9-12
9.2.2	Environmental Effects .....	9-13
9.2.3	Pathogen Inactivation Efficiency Using Interactive Disinfectants .....	9-16
9.2.4	Summary: Pathogen Inactivation with Interactive Disinfectants.....	9-23
9.3	ANALYTICAL METHODS.....	9-23
9.3.1	Ozone .....	9-23
9.3.2	Chlorine Dioxide.....	9-24
9.3.3	Potassium Permanganate .....	9-24
9.3.4	Chloramine .....	9-24
9.3.5	Hydrogen Peroxide.....	9-24
9.3.6	UV Radiation.....	9-24
9.3.7	Summary of Analytical Methods.....	9-24
9.4	SUMMARY .....	9-25
9.5	REFERENCES .....	9-26

Table 9-1.	Potential Primary Disinfectants .....	9-2
Table 9-2.	Primary/Secondary Disinfectant Combinations and Typical Applications in Water Treatment.....	9-3
Table 9-3.	DBPs Associated with Various Combined Oxidation/Disinfection Processes .....	9-4
Table 9-4.	Strategies for Primary and Secondary Disinfectants.....	9-6
Table 9-5.	Impacts of Disinfection Practice on DBP Formation.....	9-7
Table 9-6.	Virus Inactivation By Individual Disinfectants and Simultaneous Chloramination.....	9-17
Table 9-7.	<i>C. parvum</i> Inactivation Using Ozone Followed by Chlorine Dioxide .....	9-19
Table 9-8.	<i>C. parvum</i> Inactivation Using Chlorine Dioxide Followed by Free Chlorine .....	9-19
Table 9-9.	<i>G. muris</i> Inactivation Using Chlorine Dioxide Followed by Free Chlorine .....	9-19
Table 9-10.	<i>B. cereus</i> Inactivation Using Chlorine Dioxide Followed by Free Chlorine .....	9-19
Table 9-11.	<i>C. parvum</i> Inactivation Using Chlorine Dioxide Followed by Chloramine .....	9-20
Table 9-12.	<i>G. muris</i> Inactivation Using Chlorine Dioxide Followed by Chloramine .....	9-20
Table 9-13.	<i>G. muris</i> Inactivation Using Ozone Followed by Free Chlorine.....	9-21
Table 9-14.	<i>B. cereus</i> Inactivation Using Chlorine Dioxide Followed by Free Chlorine .....	9-21
Table 9-15.	<i>G. muris</i> Inactivation Using Ozone Followed by Chloramine.....	9-21
Table 9-16.	<i>G. muris</i> Inactivation by Free Chlorine Followed by Monochloramine.....	9-22
Table 9-17.	<i>C. parvum</i> Inactivation by Sequential Application of Ozone and Chloramine.....	9-22
Table 9-18.	Summary of Combined Disinfectants .....	9-25

Figure 9-1.	Inactivation of <i>C. parvum</i> Attributed to Synergistic Effects. Application of Ozone Followed by Chlorine Dioxide .....	9-14
-------------	---	------

Figure 9-2. Inactivation of *C. parvum* Attributed to Synergistic Effects. Application of Chlorine Dioxide Followed by Free Chlorine..... 9-14

Figure 9-3. Inactivation of *C. parvum* Attributed to Synergistic Effects. Application of Chlorine Dioxide Followed by Monochloramine..... 9-15

Figure 9-4. Inactivation of *E. coli* Using Free Chlorine and Monochloramine..... 9-18

# APPENDIX A - SUMMARY OF DISINFECTANT USAGE IN THE UNITED STATES

Two sources of information were consulted regarding disinfectant usage in the United States:

- The Community Water Systems Survey (USEPA, 1997); and
- The Information Collection Rule (ICR) database on water utilities (presently under development).

## A.1 Community Water Systems Survey

Most water treatment plants disinfect water prior to distribution. The 1995 Community Water Systems Survey (USEPA 1997a) reports that 81 percent of all community water systems provide some form of treatment on all or a portion of their water sources (Table A-1). The survey found that 99 percent of the surface water systems provide some treatment of their water. Of those systems reporting no treatment, 80 percent rely on ground water as their only water source.

**Table A-1. Disinfection Practices of Water Systems with Treatment**

Treatment	Service Population								Total
	<100	101-500	501-1,000	1,001-3,300	3,301-10,000	10,001-50,000	50,001-100,000	Over 100,001	
<b>Surface Water Systems</b>									
<b>Pre-Disinfection, Oxidation/Softening</b>									
Chlorine	59.0%	73.9%	67.3%	66.3%	68.8%	58.6%	47.5%	57.1%	63.8%
Chlorine Dioxide	0.0%	0.0%	0.0%	5.0%	4.7%	13.2%	14.2%	7.8%	6.3%
Chloramines	4.6%	0.0%	1.1%	2.1%	0.0%	2.2%	15.5%	10.8%	3.1%
Ozone	0.0%	0.0%	0.0%	0.0%	0.3%	0.0%	5.4%	5.8%	0.9%
KMnO4	0.0%	4.9%	9.6%	9.9%	15.2%	28.3%	25.9%	28.5%	16.0%
Predisinfection/oxidation	0.0%	0.0%	2.0%	2.9%	0.6%	9.2%	5.1%	4.3%	3.5%
Lime/Soda ash softening	6.8%	9.8%	20.9%	16.2%	14.3%	11.7%	3.5%	5.9%	12.5%
Recarbonation	0.0%	0.0%	0.0%	0.0%	2.1%	4.7%	0.6%	6.3%	1.9%
<b>Post-Disinfection</b>									
Chlorine	49.7%	51.6%	80.6%	62.8%	77.9%	71.1%	73.8%	63.6%	67.5%
Chlorine Dioxide	0.0%	0.0%	0.0%	0.0%	0.3%	4.9%	5.9%	11.2%	1.6%
Chloramines	0.0%	0.0%	0.0%	2.9%	2.1%	15.6%	29.4%	24.2%	8.1%
Postdisinfection combine	0.0%	0.0%	0.0%	2.1%	4.0%	3.9%	1.9%	1.6%	3.0%
Fluoridation	0.0%	4.9%	13.9%	32.4%	42.6%	48.8%	49.9%	63.6%	35.5%
<b>Ground Water Systems</b>									
<b>Pre-Disinfection, Oxidation/Softening</b>									
Chlorine	64.2%	69.9%	56.7%	73.2%	60.6%	57.4%	36.2%	38.1%	63.9%
Chlorine Dioxide	1.3%	0.0%	0.0%	0.0%	0.0%	0.0%	3.1%	0.0%	0.3%
Chloramines	0.0%	0.0%	0.0%	0.0%	0.0%	0.6%	1.4%	0.7%	0.1%
Ozone	0.0%	0.0%	0.0%	0.0%	0.0%	0.0%	0.0%	0.6%	0.0%
KMnO4	0.0%	0.9%	2.2%	0.6%	5.8%	3.2%	7.0%	0.0%	1.8%
Predisinfection/oxidation	0.3%	0.5%	0.0%	0.7%	1.0%	2.6%	0.0%	0.0%	0.7%
Lime/Soda ash softening	2.9%	2.9%	2.2%	3.6%	3.5%	3.8%	5.0%	9.1%	3.2%
Recarbonation	0.0%	0.5%	0.0%	0.6%	1.4%	1.5%	2.8%	1.1%	0.6%
<b>Post-Disinfection</b>									
Chlorine	23.0%	23.4%	32.5%	28.3%	42.5%	41.9%	54.5%	65.8%	31.0%
Chlorine Dioxide	0.0%	1.0%	0.0%	0.0%	0.0%	0.6%	0.0%	0.0%	0.4%
Chloramines	0.0%	0.0%	0.0%	0.0%	0.1%	1.1%	3.9%	4.3%	0.3%
Postdisinfection combine	0.0%	0.0%	0.0%	0.0%	0.1%	0.1%	0.0%	0.0%	0.0%
Fluoridation	2.4%	6.3%	13.2%	12.4%	45.3%	31.2%	34.3%	52.5%	16.0%

Source: 1995 Community Water Systems survey (USEPA, 1997a)

## A.2 Information Collection Rule Database

The ICR database contains information from 527 community water systems. Some of these systems are owned by the same utility, representing different treatment plants within the same organization. The following tables summarize the ICR data regarding disinfectant database entries. Note that the information about disinfectant includes usage of the disinfectant at the given utility. In some cases, the utility may use more than one disinfectant. Therefore, the 527 systems reported use of 740 different disinfectants. Three systems reported using 3 different chemical disinfectants - for different purposes or during different times of the year. The tables show a breakdown of the disinfectant usage at these facilities. Capacities are shown in terms of flow. Population served data are not recorded.

The tables are as follows:

- Table A-2 shows the breakdown of systems based on water source (i.e., surface or ground water).
- Table A-3 to Table A-5 shows the disinfectant usage at water plants by flow categories for all water sources, surface water sources, and ground water sources, respectively. The tables show the percentage of facilities that are using the particular disinfectant. Because some facilities use more than one disinfectant, the total usage exceeds 100 percent. For example, for facilities in the range 51-100 mgd, the total disinfectant usage is 155 percent. This means that 155 types of disinfection systems are used at 100 plants.
- Table A-6 through Table A-8 shows the disinfectant usage in number of applications in water plants by flow categories for all water sources, surface water sources, and ground water sources, respectively. These tables show the actual numbers used in calculating the percentages in Table A-3 to Table A-5.
- Table A-9 through Table A-11 show the number of systems using two or more disinfectants for all water sources, surface water sources, and ground water sources, respectively. The database does not separate usage as primary or secondary disinfectant.

**Table A-2. Breakdown of systems in Survey based on Water Source**

<b>Systems</b>	<b>GW</b>	<b>SW</b>	<b>GW/SW</b>	<b>Unknown</b>	<b>Total</b>
Number	135	390	2	2	529
Percentage	26%	74%	0%	0%	100%

GW = Ground Water; SW = Surface Water; GW/SW = Choice of Ground or Surface Water Source.

**Table A-3. Disinfectant usage as a function of flow for all Water Sources.  
Numbers show the percentage of systems using a particular disinfectant**

Flow, mgd	Cl <sub>2</sub>	NaOCl	NH <sub>2</sub> Cl <sub>2</sub>	O <sub>3</sub>	ClO <sub>2</sub>	Total use
0-5	69%	19%	19%	0%	0%	106%
6-10	90%	10%	10%	0%	0%	110%
11-50	93%	6%	30%	5%	9%	143%
51-100	95%	5%	41%	5%	9%	155%
>100	98%	5%	43%	5%	3%	154%
Unknown	77%	13%	8%	0%	0%	98%
Percentage*	92%	7%	31%	4%	6%	140%

Percentage calculated as a fraction of 527 - the total number of systems. 740 different disinfectants are used by the 527 systems.

**Table A-4. Disinfectant usage as a function of flow for Surface Water Sources.  
Numbers show the percentage of systems using a particular disinfectant**

Flow, mgd	Cl <sub>2</sub>	NaOCl	NH <sub>2</sub> Cl	O <sub>3</sub>	ClO <sub>2</sub>	Total use
0-5	89%	11%	0%	0%	0%	100%
6-10	85%	8%	8%	0%	0%	100%
11-50	93%	5%	32%	5%	12%	148%
51-100	96%	4%	42%	6%	11%	158%
>100	96%	6%	46%	6%	4%	158%
Unknown	88%	13%	50%	0%	0%	150%
Percentage*	94%	5%	37%	5%	9%	150%

Percentage calculated as a fraction of 527 - the total number of systems. 576 different disinfectants are used by the 383 systems.

**Table A-5. Disinfectant usage as a function of flow for Ground Water Sources.  
Numbers show the percentage of systems using a particular disinfectant**

Flow, mgd	Cl <sub>2</sub>	NaOCl	NH <sub>2</sub> Cl	O <sub>3</sub>	ClO <sub>2</sub>	Total use
0-5	43%	29%	43%	0%	0%	114%
6-10	94%	13%	13%	0%	0%	119%
11-50	92%	6%	24%	2%	2%	125%
51-100	88%	13%	38%	0%	0%	138%
>100	108%	0%	25%	0%	0%	133%
Unknown	79%	14%	0%	0%	0%	93%
Percentage*	87%	10%	18%	1%	1%	117%

Percentage calculated as a fraction of 527 - the total number of systems. 168 different disinfectants are used by the 144 systems.

**Table A-6. Disinfectant usage as a function of flow for all Water Sources**

Flow, mgd	Cl <sub>2</sub>	NaOCl	NH <sub>2</sub> Cl	O <sub>3</sub>	ClO <sub>2</sub>	Total use	Total plants
0-5	11	3	3	0	0	17	16
6-10	26	3	3	0	0	32	29
11-50	200	12	65	10	20	307	215
51-100	113	6	49	6	11	185	119
>100	94	5	41	5	3	148	96
Unknown	40	7	4	0	0	51	52
Total	484	36	165	21	34	740	527
Percentage*	92%	7%	31%	4%	6%	140%	

\* Percentage calculated as a fraction of 527 - the total number of systems. 740 different disinfectants are used by the 527 systems.

**Table A-7. Disinfectant usage as a function of flow for Surface Water Sources**

Flow, mgd	Cl <sub>2</sub>	NaOCl	NH <sub>2</sub> Cl	O <sub>3</sub>	ClO <sub>2</sub>	Total use	Total plants
0-5	8	1	0	0	0	9	9
6-10	11	1	1	0	0	13	13
11-50	154	9	53	9	20	245	165
51-100	99	4	43	6	11	163	103
>100	82	5	39	5	3	134	85
Unknown	7	1	4	0	0	12	8
Total	361	21	140	20	34	576	383
Percentage*	94%	5%	37%	5%	9%	150	

\* Percentage calculated as a fraction of 383 - the total number of plants. 576 different disinfectants are used by the 383 systems.

**Table A-8. Disinfectant usage as a function of flow for Ground Water Sources**

Flow, mgd	Cl <sub>2</sub>	NaOCl	NH <sub>2</sub> Cl	O <sub>3</sub>	ClO <sub>2</sub>	Total use	Total plants
0-5	3	2	3	0	0	8	7
6-10	15	2	2	0	0	19	16
11-50	47	3	12	1	1	64	51
51-100	14	2	6	0	0	22	16
>100	13	0	3	0	0	16	12
Unknown	33	6	0	0	0	39	42
Total	125	15	26	1	1	168	144
Percentage*	87%	10%	18%	1%	1%	117%	

\* Percentage calculated as a fraction of 144 - the total number of systems. 168 different disinfectants are used by the 144 systems.

**Table A-9. Number Water Systems (Ground and Surface Water Sources) using Two Different Disinfectants**

	Cl <sub>2</sub>	NaOCl	NH <sub>2</sub> Cl	O <sub>3</sub>	ClO <sub>2</sub>
Cl <sub>2</sub>	---	8	150	17	32
NaOCl	---	---	8	3	0
NH <sub>2</sub> Cl	---	---	---	12	18
O <sub>3</sub>	---	---	---	---	1
ClO <sub>2</sub>	---	---	---	---	---

**Table A-10. Number Surface Water Systems using Two Different Disinfectants**

	Cl <sub>2</sub>	NaOCl	NH <sub>2</sub> Cl	O <sub>3</sub>	ClO <sub>2</sub>
Cl <sub>2</sub>	---	7	129	16	31
NaOCl	---	---	7	7	3
NH <sub>2</sub> Cl	---	---	---	11	18
O <sub>3</sub>	---	---	---	---	1
ClO <sub>2</sub>	---	---	---	---	---

**Table A-11. Number Ground Water Systems using Two Different Disinfectants**

	Cl <sub>2</sub>	NaOCl	NH <sub>2</sub> Cl	O <sub>3</sub>	ClO <sub>2</sub>
Cl <sub>2</sub>	---	1	21	1	0
NaOCl	---	---	1	0	0
NH <sub>2</sub> Cl	---	---	---	1	0
O <sub>3</sub>	---	---	---	---	0
ClO <sub>2</sub>	---	---	---	---	---

THIS PAGE INTENTIONALLY LEFT BLANK

# Appendix B – Selected Costs of Alternative Disinfection Systems

---

## B.1 Technologies and Costs for Control of Disinfection By-Products

Costs were developed for modifying a “base” or “typical” treatment plant to add disinfection and other technologies. The base plant is described as a conventional treatment plant using chlorine/chlorine disinfection consisting of rapid mixing, flocculation, sedimentation, chlorination, filtration, contact basin, chemical feed systems and finished water storage. This appendix contains figures and tables from *Technologies and Costs for Control of Disinfection By-Products* (USEPA, 1998), retaining the report’s original figure and table numbers. Incremental costs are shown, determined by calculating the cost for the modified treatment plant and subtracting the base treatment plant cost.

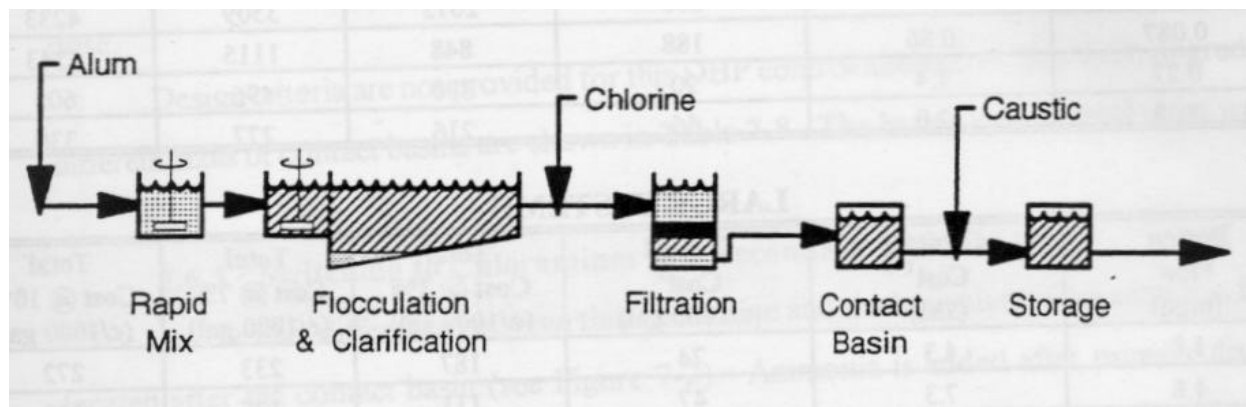
The base treatment plant shown in Figure 7-1, is a basic alum coagulation and filtration plant, with chlorine disinfection. This plant was modified to meet disinfection requirements. The bases for the cost estimates are shown in Tables 7-3, 7-4, 7-5, and 7-6. The 12 flow categories for which the costs were determined are shown in Table 7-2.

Schematics and costs to add the following schemes are shown in the attached figures and tables.

- Base treatment plant - Figure 7-1 and Table 7-7.
- Move point of chlorination. This modification assumes no cost for moving the chlorine addition point, but costs for an added contact basin are shown in Table 7-8.
- Change to Chlorine/Chloramine - Figure 7-2 and Table 7-9.
- Change to Ozone/Chloramine - Figure 7-3 and Table 7-12.
- Change to Chlorine Dioxide – Table 7-13.

See USEPA, 1998 for more details and information upon the costs of other technologies.

**FIGURE 7-1. ALUM COAGULATION / FILTRATION BASE PLANT**



**TABLE 7-2. EPA FLOW CATEGORIES**

EPA FLOW CATEGORIES	POPULATION	AVERAGE FLOW (mgd)	CAPACITY (mgd)
1		0.0056	
2		0.024	
3		0.086	
4		0.23	
<b>LARGE SYSTEMS - DESIGN FLOW &gt; 1 MGD</b>			
	5,500		1.8
	15,000		4.8
	35,000		11
	60,000		18
	88,000		26
	175,000		51
	73	120	
12		270	
12a		350	

**TABLE 7-3. SMALL SYSTEMS BASIS FOR COST ESTIMATES FOR DBP CONTROL**

Process	WATER Model Assumptions	Engineering Assumption
Package Raw Water Pumping	<p>Premanufactured packaged pumping station using submersible pump contained in a 20 ft deep steel pump sump.</p> <p>Manifold piping, sump intake valve, pump check valves, and electrical controls.</p> <p>Total dynamic head is 50 ft.</p> <p>Pump and motor efficiencies are 80 and 90%, respectively.</p>	
Package Complete Treatment Plant	<p>Coagulation, flocculation, sedimentation, and filtration equipment provided including tube settlers rated at 1,500 gpd/sf, mixed media filters with application rates of 2 to 5 gpm/sf and media depth of 30 in.</p> <p>Chemical feed facilities include storage tanks and feed pumps.</p> <p>Filter backwash pumps and, where applicable, surface wash water pumps.</p> <p>Flow measurement and control devices, pneumatic air supply (for 200 gpm or larger plants), effluent pumps, and building.</p>	
Hypochlorite Solution	Solution tanks, mixers, and metering pumps	Sodium hypochlorite dose of 2.4 mg/L determined by WTP model.
Chlorination System	Metering pumps, PVC pipes, valves and controls are included.	
Sodium Hydroxide Feed System	<p>Storage tanks, heater, manual transfer pump, mixers, feed tanks and metering pumps are included.</p> <p>PVC pipes, valves and control are also included.</p>	
Alum Feed System	<p>Solution tanks, mixers, and calibrated metering pumps are included.</p> <p>PVC pipes, valves and controls are also included.</p>	Alum dose is determined by DBP control alternatives.

**TABLE 7-3. SMALL SYSTEMS BASIS FOR COST ESTIMATES FOR DBP CONTROL**

<b>Process</b>	<b>WATER Model Assumptions</b>	<b>Engineering Assumption</b>
Package High Service Pump Station	Includes 2 or 3 centrifugal pumps, pressure sensing, flow control valves, instrumentation and equipment.  Pumps provide a maximum output of 70 psi.	
Clearwell Storage Above Ground	Above ground, steel tanks including instrumentation and control of clearwell water level and instrumentation for turbidity and residual monitoring is provided.	Clearwell size is based on storage of 25% of the daily operating flow.
Sludge Dewatering Lagoons	Unlined lagoon and inlet, outlet structures are provided.  2 ft freeboard, 3:1 side slopes, 5 ft depth are also provided.	Sizing of lagoons is based on solids content of 5%.  Sludge is thickened to a solids concentration of 30%.
Dewatered Sludge Hauling	Loading facilities including sludge conveyer, hopper, and hopper enclosure are provided.  Length of haul is 20 miles one-way.	
Contact Basin		Below ground tanks without repumping are assumed.  Size of basin is 60 minutes, as determined by the WTP model.  The well baffled tanks are assumed to provide actual contact time of 0.7 times the theoretical according to the SWTR Guidance Manual.  O&M costs were unpredictable and were assumed to be negligible.

**TABLE 7-4. LARGE SYSTEMS BASIS FOR COST ESTIMATES FOR DBP CONTROL**

<b>Process</b>	<b>WATER Model Assumptions</b>	<b>Engineering Assumption</b>
Raw Water Pumping	Total dynamic head 100 ft  Manifold piping velocity  Standby pump, manifold piping, and instrumentation are provided	
Alum Feed System	Diaphragm metering pumps, steel storage hoppers with dust collector, and mechanical weight belt feeders  Commercial alum density 60 lb/cu ft  Dissolving tank detention time 5 min with 2 gal of water per lb of dry alum added  Maximum hopper volume 6,000 cu ft with fifteen days of storage	Alum dose is determined by DBP control alternatives
Rapid Mix	Vertical shaft, variable speed turbine mixers with stainless steel shafts and paddles and TEFC motors  Maximum basin capacity 2,500 cu ft  Water temperature 15" C Overall mechanism efficiency 70%	G = 900/sec  Detention time is 1 min at design flow
Flocculation (Horizontal Paddle)	Rectangular-shaped, reinforced concrete basins with 12 ft depth, 4:1 length to width ratio, and 12,500 cu ft individual maximum basin size  Variable speed drive units requiring 15 min/day routine O&M and an oil change every 6 months requiring 4 hrs of labor  Overall mechanism efficiency 60%	G = 50/sec  Detention time is 30 min at design flow
Rectangular Clarifiers	Chain and flight collector with drive mechanism, sludge pumps, reinforced concrete structure, and withdraw pumps are included	Overflow rate = 1,000 gpd/sq ft

**TABLE 7-4. LARGE SYSTEMS BASIS FOR COST ESTIMATES FOR DBP CONTROL**

<b>Process</b>	<b>WATER Model Assumptions</b>	<b>Engineering Assumption</b>
	Side wall depth = 12 ft	Maximum number of units is 2 Maximum basin area = 20,000 sq ft
Gravity Filtration Systems	Filter structure, underdrains, wash water troughs, pipe gallery piping and valves, instrumentation, control panel, and filter housing are provided  Filter box depth = 16 ft  Maximum filter size = 1,275 sq ft	Minimum 4 filters per plant  Filter loading rate = 4 gpm/sq ft
Filtration Dual Media	20 in of 1.0 to 1.2 mm effective size anthracite coal (UC = 1.7)  10 in of 0.42 to 0.52 mm effective size silica sand (UC = 1.6)  12 in underdrains. Media consisting of 4 sizes of silica gravel	
Backwash Pumping Facilities	All required pumps and motors, flow control, sequencing control, valves and backwash headers are included  Pumping head = 50 ft  Overall mechanism efficiency 70%	Backwash rate = 18 gpm/sq ft  One filter is backwashed at a time with each filter backwashed approximately every two days
Wash Water Surge Basins	Below ground, reinforced concrete basins and level control instrumentation provided	Sized to store a 20 min volume of backwash water at design flow
Unthickened Sludge Pumping	Variable speed, centrifugal pumps, piping and valves, electrical equipment housing, dry well, and a wet well are included  Pipe velocity = 5 ft/sec  Total dynamic head = 30 ft	Unthickened sludge solids concentration = 1%  12 hr/day of sludge pumping

**TABLE 7-4. LARGE SYSTEMS BASIS FOR COST ESTIMATES FOR DBP CONTROL**

<b>Process</b>	<b>WATER Model Assumptions</b>	<b>Engineering Assumption</b>
	Overall pump-motor efficiency = 65%	
Sludge Dewatering Lagoons	Unlined lagoon and inlet and outlet structures are provided  2 ft freeboard, 3:1 side slopes, and 10 ft depth are also provided	Solids production is determined by WTP model  Sludge is thickened to a solids concentration of 30%  Sizing of lagoons is based on a solids content of 5%
Dewatered Sludge Hauling	Loading facilities including sludge conveyor, hopper, and hopper enclosure are provided  Length of haul is 20 miles one-way	Dewatered sludge has a solids content of 30%
In-plant Pumping	Constant speed, vertical turbine pumps, pump motor, wet well, and piping and valves are included  Pipe velocity = 5 ft/sec	Total dynamic head = 50 ft
Chlorine Feed Facilities	Chlorinator, standby chlorinator, cylinder scales, evaporators, residual analyzers with flow proportioning device injector pumps, and housing to include 30 days of cylinder storage are provided  Injector pumps deliver water at 25 psi to allow production of 3,500 mg/L solution	Chlorine dose is 2.4 mg/L as determined by WTP model
Sodium Hydroxide Feed System	Storage tanks, heater, manual transfer pump mixers, feed tanks and metering pumps are included  PVC pipes, valves and controls are also included	Sodium hydroxide dose is 16 mg/L as determined by WTP model
Finished Water Pumping	Vertical turbine pumps powered by constant speed motors, electrical equipment instrumentation, valves, and manifolds are provided  Total dynamic head is 300 ft	

**TABLE 7-4. LARGE SYSTEMS BASIS FOR COST ESTIMATES FOR DBP CONTROL**

<b>Process</b>	<b>WATER Model Assumptions</b>	<b>Engineering Assumption</b>
	Standby pump is also included	

**TABLE 7-5. COST ALLOWANCE FACTORS**

Item	Small Systems Water Model (%)	Large Systems WATERCOST Model(%)
Site work and Interface	10	15
Piping	10	10
Subsurface Considerations	5	5
Standby Power		
General Contractors Overhead and Profit	12	12
Engineering	15 <sup>(1)</sup>	15 <sup>(2)</sup>
Legal, Fiscal and Administration fees	5 to 6 <sup>(1)</sup>	9 to 11 <sup>(2)</sup>
Notes:		
<sup>(1)</sup> Percentages added to estimated construction cost plus estimated cost for other allowances factors.		
<sup>(2)</sup> Percentages added to estimated construction cost only.		

**TABLE 7-6. INDICES USED IN THE ESCALATION OF COSTS**

DESCRIPTION	INDEX REFERENCE	NUMERICAL VALUE	ESCALATION VALUE
<b>Building Cost Index</b>	ENR <sup>1</sup>	3391.86	1.23
<b>Chemical &amp; Allied Products</b>	BLS <sup>2</sup>	147.2	1.19
<b>Skilled Labor</b>	ENR <sup>1</sup>	5231.35	1.178
<b>Materials</b>	ENR <sup>1</sup>	2268.57	1.328
<b>Utility Natural Gas</b>	BLS 055 <sup>2</sup>	111.3	1.679

<sup>1</sup> Engineering News Record (July, 1997)

<sup>2</sup> Bureau of Labor Statistics (March, 1997)

TABLE 7-7. ESTIMATED BASE PLANT COSTS

## SMALL SYSTEMS

Design Flow (mgd)	Capital Cost <sup>1</sup> (\$M)	O & M Cost <sup>2</sup> (4/1000 gal)	Total Cost @ 3% (4/1000 gal)	Total Cost @ 7% (4/1000 gal)	Total Cost @ 10% (4/1000 gal)
0.024	0.63	600	2672	3509	4233
0.087	0.86	188	848	1115	1343
0.27	1.4	90	390	496	605
0.65	2.0	56	216	277	330

## LARGE SYSTEMS

Design Flow (mgd)	Capital Cost <sup>1</sup> (\$M)	O & M Cost <sup>2</sup> (4/1000 gal)	Total Cost @ 3% (4/1000 gal)	Total Cost @ 7% (4/1000 gal)	Total Cost @ 10% (4/1000 gal)
1.8	4.3	74	187	233	272
4.8	7.3	47	111	137	159
11	12	39	83	102	118
18	17	36	72	86	98
26	22	35	66	78	89
51	36	33	58	68	76
210	120	32	50	58	65
430	230	31	47	53	59
520	380	26	46	54	61

<sup>1</sup> 1991 Cost escalated based upon a factor of 1.23 derived from the ENR BCI

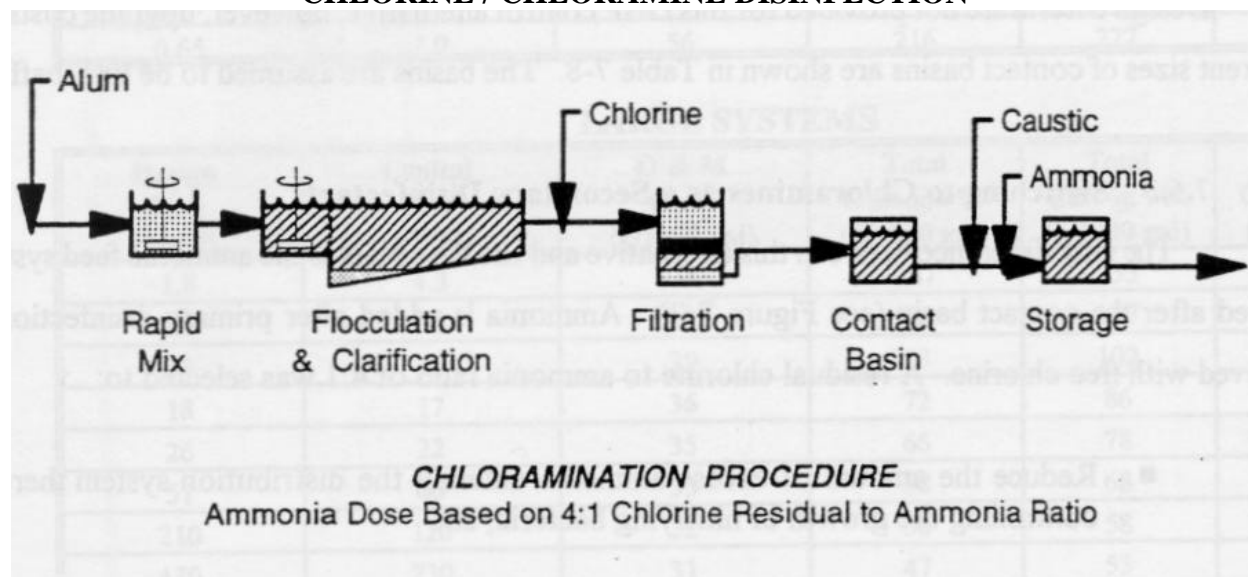
<sup>2</sup> 1991 Cost escalated based upon a factor of 1.19 derived from the BLS Chemical and Allied Products Index

**TABLE 7-8. ESTIMATED UPGRADE COSTS FOR ADDITIONAL CONTACT BASIN SIZE (x \$1000) <sup>1</sup>**

DESIGN FLOW	Chlorine Contact Basin Time						
	30 min	60 min	120 min	180 min	240 min	300 min	360 min
0.024	14	21	26	28	38	46	55
0.087	25	34	66	76	82	84	100
0.27	52	80	103	140	180	220	234
0.65	77	112	218	251	284	317	351
1.8	197	244	335	427	519	611	702
4.8	274	396	642	887	1,132	1,376	1622
11	432	713	1,274	1,836	2,399	2,961	3521
18	611	1,070	1,990	2,909	3,828	4,748	5667
26	815	1,478	2,807	4,135	5,462	6,791	8118
51	1,454	2,755	5,360	7,965	10,569	13,175	15,778
210	5514	10,876	21,600	32,324	43,050	53,774	64,499
430	11,132	22,112	44,071	66,031	87,991	109,951	131,910
520	13,374	26,639	53,224	79,785	106,352	132,193	159,456

<sup>1</sup> 1991 Cost escalated based upon a factor of 1.23 derived from the ENR BCI

**FIGURE 7-2. ALUM COAGULATION / FILTRATION SYSTEM UPGRADED WITH CHLORINE / CHLORAMINE DISINFECTION**



**TABLE 7-9. ESTIMATED UPGRADE COSTS FOR CHLORAMINES AS SECONDARY DISINFECTANT**

**SMALL SYSTEMS**

Design Flow (mgd)	Capital Cost <sup>1</sup> (\$M)	O & M Cost <sup>2</sup> (4/1000 gal)	Total Cost @ 3% (4/1000 gal)	Total Cost @ 7% (4/1000 gal)	Total Cost @ 10% (4/1000 gal)
0.024	0.011	21	57	71	83
0.087	0.012	5.5	15	19	22
0.27	0.015	1.9	5.1	6.3	7.4
0.65	0.016	0.98	2.3	2.8	3.2

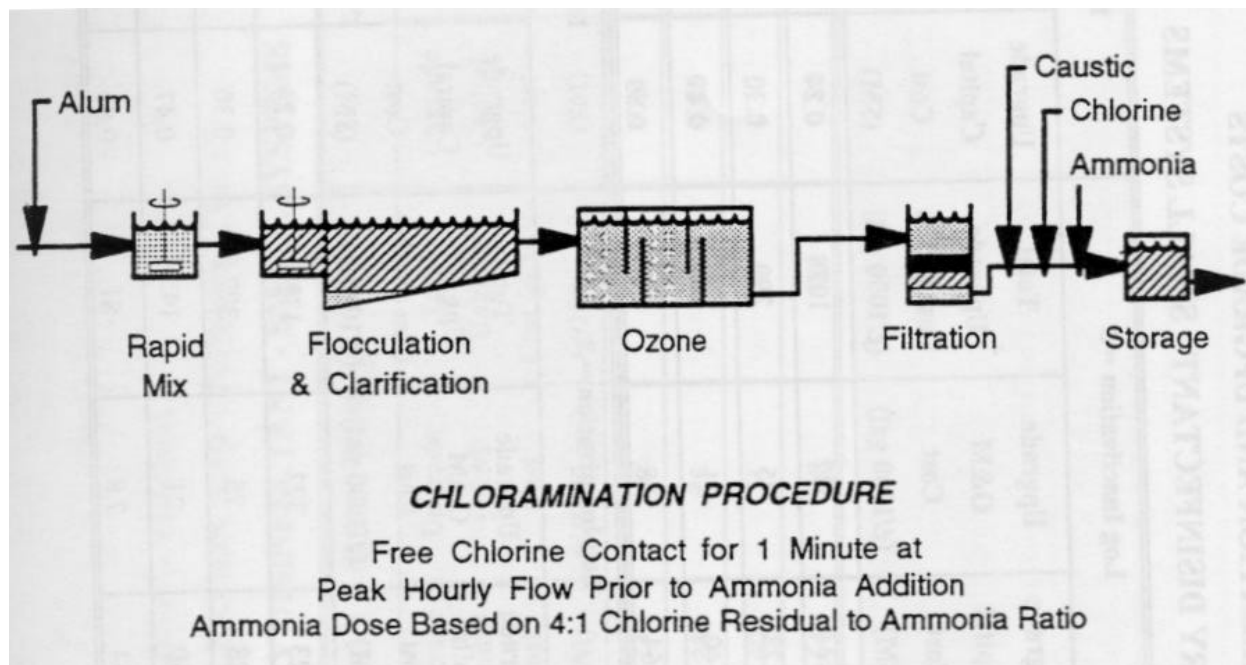
**LARGE SYSTEMS**

Design Flow (mgd)	Capital Cost <sup>1</sup> (\$M)	O & M Cost <sup>2</sup> (4/1000 gal)	Total Cost @ 3% (4/1000 gal)	Total Cost @ 7% (4/1000 gal)	Total Cost @ 10% (4/1000 gal)
1.8	0.04	1.4	2.5	3.0	3.4
4.8	0.07	0.70	1.3	1.5	1.8
11	0.11	0.49	0.9	1.1	1.2
18	0.16	0.40	0.73	0.87	0.99
26	0.21	0.37	0.67	0.79	0.89
51	0.28	0.33	0.52	0.60	0.67
210	0.47	0.29	0.36	0.39	0.41
430	0.85	0.26	0.32	0.34	0.36
520	0.91	0.20	0.25	0.27	0.28

<sup>1</sup> 1991 Cost escalated based upon a factor of 1.23 derived from the ENR BCI

<sup>2</sup> 1991 Cost escalated based upon a factor of 1.19 derived from the BLS Chemical and Allied Products Index

**FIGURE 7-3. ALUM COAGULATION / FILTRATION SYSTEMS UPGRADED WITH OZONE / CHLORAMINE DISINFECTION**



**TABLE 7- 12. ESTIMATED INSTALLATION AND UPGRADE COSTS FOR OZONE AS PRIMARY DISINFECTANT - SMALL SYSTEMS**

Design Flow (mgd)	Log Inactivation = 1			Log Inactivation = 3			Log Inactivation = 5		
	Upgrade Capital Cost (\$M)	Upgrade O&M Cost (4/1000 gal)	Total Upgrade Cost @ 3% (4/1000 gal)	Upgrade Capital Cost (\$M)	Upgrade O&M Cost (4/1000 gal)	Total Upgrade Cost @ 3% (4/1000 gal)	Upgrade Capital Cost (\$M)	Upgrade O&M Cost (4/1000 gal)	Total Upgrade Cost @ 3% (4/1000 gal)
0.024	0.22	161	885	0.23	322	1078	0.24	644	1433
0.086	0.24	38	222	0.28	75	290	0.30	150	380
0.27	0.29	10	72	0.40	21	107	0.47	42	143
0.65	0.39	3.9	35	0.64	7.8	59	0.80	16	80
Design Flow (mgd)	Log Inactivation = 1			Log Inactivation = 3			Log Inactivation = 5		
	Upgrade Capital Cost (\$M)	Upgrade O&M Cost (4/1000 gal)	Total Upgrade Cost @ 7% (4/1000 gal)	Upgrade Capital Cost (\$M)	Upgrade O&M Cost (4/1000 gal)	Total Upgrade Cost @ 7% (4/1000 gal)	Upgrade Capital Cost (\$M)	Upgrade O&M Cost (4/1000 gal)	Total Upgrade Cost @ 7% (4/1000 gal)
0.024	0.22	161	1177	0.23	322	1384	0.24	644	1752
0.086	0.24	38	297	0.28	75	377	0.30	150	473
0.27	0.29	10	97	0.40	21	145	0.47	42	183
0.65	0.39	3.9	48	0.64	7.8	81	0.80	16	106

TABLE 7- 12 (cont)

## ESTIMATED INSTALLATION AND UPGRADE COSTS FOR OZONE AS PRIMARY DISINFECTANT - SMALL SYSTEMS

Design Flow (mgd)	Log Inactivation = 1			Log Inactivation = 3			Log Inactivation = 5		
	Upgrade Capital Cost (\$M)	Upgrade O&M Cost (4/1000 gal)	Total Upgrade Cost @ 10% (4/1000 gal)	Upgrade Capital Cost (\$M)	Upgrade O&M Cost (4/1000 gal)	Total Upgrade Cost @ 10% (4/1000 gal)	Upgrade Capital Cost (\$M)	Upgrade O&M Cost (4/1000 gal)	Total Upgrade Cost @ 10% (4/1000 gal)
0.024	0.22	161	1442	0.23	322	1661	0.24	644	2023
0.086	0.24	38	361	0.28	75	445	0.30	150	551
0.27	0.29	10	119	0.40	21	170	0.47	42	217
0.65	0.39	3.9	59	0.64	7.8	98	0.80	16	128

**TABLE 7- 12 (cont.)  
ESTIMATED INSTALLATION AND UPGRADE COSTS FOR OZONE AS PRIMARY DISINFECTANT -  
LARGE SYSTEMS**

Design Flow (mgd)	Log Inactivation = 1			Log Inactivation = 3			Log Inactivation = 5		
	Upgrade Capital Cost (\$M)	Upgrade O&M Cost (4/1000 gal)	Total Upgrade Cost @3% (4/1000 gal)	Upgrade Capital Cost (\$M)	Upgrade O&M Cost (4/1000 gal)	Total Upgrade Cost @ 3% (4/1000 gal)	Upgrade Capital Cost (\$M)	Upgrade O&M Cost (4/1000 gal)	Total Upgrade Cost @ 3% (4/1000 gal)
1.8	0.89	1.8	25	1.5	4.4	44	1.4	6.3	43
4.8	1.5	1.8	15	1.9	4.4	21	2.0	6.3	24
11	1.9	1.8	9.0	2.6	4.4	14	2.8	6.3	17
18	2.4	1.8	7.0	3.0	4.4	11	3.7	6.3	14
26	2.6	1.8	5.5	3.9	4.4	9.9	4.8	6.3	13
51	3.8	1.8	4.4	6.2	4.4	8.6	7.4	6.3	11
210	9.2	1.8	3.2	18	4.4	7.2	24	6.3	10
430	16.5	1.8	2.9	35	4.4	6.8	47	6.3	9.5
520	20	1.8	2.9	42	4.4	6.6	57	6.3	9.3

**TABLE 7- 12 (cont.)  
ESTIMATED INSTALLATION AND UPGRADE COSTS FOR OZONE AS PRIMARY DISINFECTANT -  
LARGE SYSTEMS**

Design Flow (mgd)	Log Inactivation = 1			Log Inactivation = 3			Log Inactivation = 5		
	Upgrade Capital Cost (\$M)	Upgrade O&M Cost (4/1000 gal)	Total Upgrade Cost @ 7% (4/1000 gal)	Upgrade Capital Cost (\$M)	Upgrade O&M Cost (4/1000 gal)	Total Upgrade Cost @ 7% (4/1000 gal)	Upgrade Capital Cost (\$M)	Upgrade O&M Cost (4/1000 gal)	Total Upgrade Cost @ 7% (4/1000 gal)
1.8	0.89	1.8	35	1.5	4.4	58	1.4	6.3	56
4.8	1.5	1.8	21	1.9	4.4	28	2.0	6.3	31
11	1.9	1.8	12	2.6	4.4	17	2.8	6.3	21
18	2.4	1.8	8.9	3.0	4.4	13	3.7	6.3	17
26	2.6	1.8	7.2	3.9	4.4	12	4.8	6.3	15
51	3.8	1.8	5.6	6.2	4.4	10	7.4	6.3	13
210	9.2	1.8	4.0	18	4.4	7.8	24	6.3	11
430	16.5	1.8	3.6	35	4.4	7.4	47	6.3	11
520	20	1.8	3.4	42	4.4	6.1	57	6.3	10

**TABLE 7- 12 (cont.)  
ESTIMATED INSTALLATION AND UPGRADE COSTS  
FOR OZONE AS PRIMARY DISINFECTANT  
LARGE SYSTEMS**

Design Flow (mgd)	Log Inactivation = 1			Log Inactivation = 3			Log Inactivation = 5		
	Upgrade Capital Cost (\$M)	Upgrade O&M Cost (4/1000 gal)	Total Upgrade Cost @ 10% (4/1000 gal)	Upgrade Capital Cost (\$M)	Upgrade O&M Cost (4/1000 gal)	Total Upgrade Cost @ 10% (4/1000 gal)	Upgrade Capital Cost (\$M)	Upgrade O&M Cost (4/1000 gal)	Total Upgrade Cost @ 10% (4/1000 gal)
1.8	0.89	1.8	43	1.5	4.4	72	1.4	6.3	69
4.8	1.5	1.8	26	1.9	4.4	34	2.0	6.3	37
11	1.9	1.8	14	2.6	4.4	21	2.8	6.3	24
18	2.4	1.8	11	3.0	4.4	15	3.7	6.3	20
26	2.6	1.8	8.4	3.9	4.4	14	4.8	6.3	18
51	3.8	1.8	6.5	6.2	4.4	11	7.4	6.3	15
210	9.2	1.8	4.5	18	4.4	8.7	24	6.3	12
430	16	1.8	4.0	35	4.4	8.2	47	6.3	12
520	20	1.8	3.6	42	4.4	8.2	57	6.3	10

**TABLE 7-13 ESTIMATED INSTALLATION AND UPGRADE COSTS  
FOR CHLORINE DIOXIDE AS PRIMARY DISINFECTANT  
(MANUAL GENERATOR)  
SMALL SYSTEMS**

Design Flow (mgd)	Log Inactivation = 1			Log Inactivation = 3			Log Inactivation = 5		
	Upgrade Capital Cost <sup>(1)</sup> (\$M)	Upgrade O&M Cost (¢/1000gal)	Total Upgrade Cost @ 3% (¢/1000gal)	Upgrade Capital Cost <sup>(1)</sup> (\$M)	Upgrade O&M Cost (¢/1000gal)	Total Upgrade Cost @ 3% (¢/1000gal)	Upgrade Capital Cost <sup>(1)</sup> (\$M)	Upgrade O&M Cost (¢/1000gal)	Total Upgrade Cost @ 3% (¢/1000gal)
0.024	0.10	1929	2258	0.10	1934	2263	0.13	1934	2362
0.087	0.10	452	529	0.10	456	533	0.15	456	571
0.27	0.10	128	149	0.10	132	153	0.22	132	179
0.65	0.10	49	57	0.10	52	60	0.28	52	74
Design Flow (mgd)	Log Inactivation = 1			Log Inactivation = 3			Log Inactivation = 5		
	Upgrade Capital Cost <sup>(1)</sup> (\$M)	Upgrade O&M Cost (¢/1000gal)	Total Upgrade Cost @ 7% (¢/1000gal)	Upgrade Capital Cost <sup>(1)</sup> (\$M)	Upgrade O&M Cost (¢/1000gal)	Total Upgrade Cost @ 7% (¢/1000gal)	Upgrade Capital Cost <sup>(1)</sup> (\$M)	Upgrade O&M Cost (¢/1000gal)	Total Upgrade Cost @ 7% (¢/1000gal)
0.024	0.10	1929	2391	0.10	1934	2396	0.13	1934	2534
0.087	0.10	452	560	0.10	456	564	0.15	456	618
0.27	0.10	128	158	0.10	132	162	0.22	132	198
0.65	0.10	49	60	0.10	52	63	0.28	52	63

**TABLE 7-13 (cont)**  
**ESTIMATED INSTALLATION AND UPGRADE COSTS**  
**FOR CHLORINE DIOXIDE AS PRIMARY DISINFECTANT**  
**(MANUAL GENERATOR)**  
**SMALL SYSTEMS**

<b>Design Flow (mgd)</b>	<b>Upgrade Capital Cost<sup>(1)</sup> (\$M)</b>	<b>Upgrade O&amp;M Cost (¢/1000gal)</b>	<b>Total Upgrade Cost @ 10% (¢/1000gal)</b>	<b>Upgrade Capital Cost<sup>(1)</sup> (\$M)</b>	<b>Upgrade O&amp;M Cost (¢/1000gal)</b>	<b>Total Upgrade Cost @ 10% (¢/1000gal)</b>	<b>Upgrade Capital Cost<sup>(1)</sup> (\$M)</b>	<b>Upgrade O&amp;M Cost (¢/1000gal)</b>	<b>Total Upgrade Cost @ 10% (¢/1000gal)</b>
0.024	0.10	1929	2455	0.10	1934	2460	0.13	1934	2659
0.087	0.10	452	575	0.10	456	579	0.15	456	654
0.27	0.10	128	162	0.10	132	166	0.22	132	215
0.65	0.10	49	62	0.10	52	65	0.28	52	91

**TABLE 7-13 (cont.)**  
**ESTIMATED INSTALLATION AND UPGRADE COSTS**  
**FOR CHLORINE DIOXIDE AS PRIMARY DISINFECTANT**  
**(AUTOMATIC GENERATOR)**  
**SMALL SYSTEMS**

Design Flow (mgd)	Log Inactivation = 1			Log Inactivation = 3			Log Inactivation = 5		
	Upgrade Capital Cost <sup>(1)</sup> (\$M)	Upgrade O&M Cost (¢/1000gal)	Total Upgrade Cost @ 3% (¢/1000gal)	Upgrade Capital Cost <sup>(1)</sup> (\$M)	Upgrade O&M Cost (¢/1000gal)	Total Upgrade Cost @ 3% (¢/1000gal)	Upgrade Capital Cost <sup>(1)</sup> (\$M)	Upgrade O&M Cost (¢/1000gal)	Total Upgrade Cost @ 3% (¢/1000gal)
0.024	0.33	1548	2633	0.33	1552	2637	0.37	1552	2769
0.087	0.33	364	617	0.33	367	620	0.39	367	666
0.27	0.33	104	175	0.33	107	178	0.47	107	208
0.65	0.33	40	66	0.33	43	69	0.52	43	85
Design Flow (mgd)	Log Inactivation = 1			Log Inactivation = 3			Log Inactivation = 5		
	Upgrade Capital Cost <sup>(1)</sup> (\$M)	Upgrade O&M Cost (¢/1000gal)	Total Upgrade Cost @ 7% (¢/1000gal)	Upgrade Capital Cost <sup>(1)</sup> (\$M)	Upgrade O&M Cost (¢/1000gal)	Total Upgrade Cost @ 7% (¢/1000gal)	Upgrade Capital Cost <sup>(1)</sup> (\$M)	Upgrade O&M Cost (¢/1000gal)	Total Upgrade Cost @ 7% (¢/1000gal)
0.024	0.33	1548	3072	0.33	1552	3076	0.37	1552	3261
0.087	0.33	364	720	0.33	367	723	0.39	367	787
0.27	0.33	104	203	0.33	107	206	0.47	107	248
0.65	0.33	40	77	0.33	43	80	0.52	43	101

**TABLE 7-13 (cont.)  
ESTIMATED INSTALLATION AND UPGRADE COSTS  
FOR CHLORINE DIOXIDE AS PRIMARY DISINFECTANT  
(AUTOMATIC GENERATOR)  
SMALL SYSTEMS**

<b>Design Flow (mgd)</b>	<b>Upgrade Capital Cost<sup>(1)</sup> (\$M)</b>	<b>Upgrade O&amp;M Cost (¢/1000gal)</b>	<b>Total Upgrade Cost @ 10% (¢/1000gal)</b>	<b>Upgrade Capital Cost<sup>(1)</sup> (\$M)</b>	<b>Upgrade O&amp;M Cost (¢/1000gal)</b>	<b>Total Upgrade Cost @ 10% (¢/1000gal)</b>	<b>Upgrade Capital Cost<sup>(1)</sup> (\$M)</b>	<b>Upgrade O&amp;M Cost (¢/1000gal)</b>	<b>Total Upgrade Cost @ 10% (¢/1000gal)</b>
0.024	0.33	1548	3459	0.33	1552	3462	0.37	1552	3662
0.087	0.33	364	810	0.33	367	813	0.39	367	888
0.27	0.33	104	228	0.33	107	231	0.47	107	280
0.65	0.33	40	87	0.33	43	90	0.52	43	115

(1) Cost were adjusted to account for an increase in basin contact time from the information reported in Table 7-10

**TABLE 7-13 (cont.) ESTIMATED INSTALLATION AND UPGRADE COSTS  
FOR CHLORINE DIOXIDE AS PRIMARY DISINFECTANT  
(MANUAL GENERATOR)**

**LARGE SYSTEMS**

Design Flow (mgd)	Log Inactivation = 1			Log Inactivation = 3			Log Inactivation = 5		
	Upgrade Capital Cost <sup>(1)</sup> (\$M)	Upgrade O&M Cost (¢/1000gal)	Total Upgrade Cost @ 3% (¢/1000gal)	Upgrade Capital Cost <sup>(1)</sup> (\$M)	Upgrade O&M Cost (¢/1000gal)	Total Upgrade Cost @ 3% (¢/1000gal)	Upgrade Capital Cost <sup>(1)</sup> (\$M)	Upgrade O&M Cost (¢/1000gal)	Total Upgrade Cost @ 3% (¢/1000gal)
1.8	0.10	18	20.6	0.10	20	22.6	0.50	20	33
4.8	0.10	7.4	8.3	0.10	9.6	10.5	0.75	9.6	16
11	0.10	4.3	4.7	0.10	6.5	6.9	1.3	6.5	11.3
18	0.20	3.8	4.2	0.20	5.8	6.2	3.7	5.8	13.5
26	0.20	3.2	3.5	0.20	5.1	5.4	5.1	5.1	12.3
51	0.28	2.4	2.6	0.28	4.6	4.8	9.4	4.6	11
210	0.29	1.8	1.8	0.29	3.6	3.6	36	3.6	9.1
430	0.35	1.6	1.6	0.35	3.2	3.2	73	3.2	8.2
520	0.35	1.4	1.4	0.35	2.4	2.4	89	2.	7.1

**TABLE 7-13 (cont.)  
ESTIMATED INSTALLATION AND UPGRADE COSTS  
FOR CHLORINE DIOXIDE AS PRIMARY DISINFECTANT  
(MANUAL GENERATOR)  
LARGE SYSTEMS**

Design Flow (mgd)	Log Inactivation = 1			Log Inactivation = 3			Log Inactivation = 5		
	Upgrade Capital Cost <sup>(1)</sup> (\$M)	Upgrade O&M Cost (¢/1000gal)	Total Upgrade Cost @ 7% (¢/1000gal)	Upgrade Capital Cost <sup>(1)</sup> (\$M)	Upgrade O&M Cost (¢/1000gal)	Total Upgrade Cost @ 7% (¢/1000gal)	Upgrade Capital Cost <sup>(1)</sup> (\$M)	Upgrade O&M Cost (¢/1000gal)	Total Upgrade Cost @ 7% (¢/1000gal)
1.8	0.10	18	22	0.10	20	24	0.50	20	38
4.8	0.10	7.4	8.2	0.10	9.6	11	0.75	9.6	19
11	0.10	4.3	4.5	0.10	6.5	6.5	1.3	6.5	13
18	0.20	3.8	4.6	0.20	5.8	6.6	3.7	5.8	17
26	0.20	3.2	3.4	0.20	5.1	5.4	5.1	5.1	15
51	0.28	2.4	2.3	0.28	4.6	4.3	9.4	4.6	13
210	0.29	1.8	2.1	0.29	3.6	4.1	36	3.6	12
430	0.35	1.6	2.0	0.35	3.2	3.0	73	3.2	10
520	0.35	1.4	1.4	0.35	2.4	2.5	89	2.4	9.0

**TABLE 7-13 (cont.)**  
**ESTIMATED INSTALLATION AND UPGRADE COSTS**  
**FOR CHLORINE DIOXIDE AS PRIMARY DISINFECTANT**  
**(MANUAL GENERATOR)**

**LARGE SYSTEMS**

Design Flow (mgd)	Log Inactivation = 1			Log Inactivation = 3			Log Inactivation = 5		
	Upgrade Capital Cost <sup>(1)</sup> (\$M)	Upgrade O&M Cost (¢/1000gal)	Total Upgrade Cost @ 10% (¢/1000gal)	Upgrade Capital Cost <sup>(1)</sup> (\$M)	Upgrade O&M Cost (¢/1000gal)	Total Upgrade Cost @ 10% (¢/1000gal)	Upgrade Capital Cost <sup>(1)</sup> (\$M)	Upgrade O&M Cost (¢/1000gal)	Total Upgrade Cost @ 10% (¢/1000gal)
1.8	0.10	18	22	0.10	20	25	0.50	20	43
4.8	0.10	7.4	8.8	0.10	10	11	0.75	10	21
11	0.10	4.3	4.9	0.10	6.5	7.1	1.3	6.5	15
18	0.20	3.8	4.5	0.20	5.8	6.5	3.7	5.8	19
26	0.20	3.2	3.7	0.20	5.1	5.6	5.1	5.1	18
51	0.28	2.4	2.8	0.28	4.3	4.6	9.4	4.3	15
210	0.29	1.8	1.9	0.29	3.5	3.6	36	3.5	13
430	0.35	1.6	1.7	0.35	3.2	3.2	73	3.2	12
520	0.35	1.4	1.4	0.35	2.4	2.5	89	2.4	11

<sup>(1)</sup> Cost were adjusted to account for an increase in basin contact time from the information reported in Table 7-10

**TABLE 7-13 (cont.)  
ESTIMATED INSTALLATION AND UPGRADE COSTS  
FOR CHLORINE DIOXIDE AS PRIMARY DISINFECTANT  
(AUTOMATIC GENERATOR)**

**LARGE SYSTEMS**

Design Flow (mgd)	Log Inactivation = 1			Log Inactivation = 3			Log Inactivation = 5		
	Upgrade Capital Cost <sup>(1)</sup> (\$M)	Upgrade O&M Cost (¢/1000gal)	Total Upgrade Cost @ 3% (¢/1000gal)	Upgrade Capital Cost <sup>(1)</sup> (\$M)	Upgrade O&M Cost (¢/1000gal)	Total Upgrade Cost @ 3% (¢/1000gal)	Upgrade Capital Cost <sup>(1)</sup> (\$M)	Upgrade O&M Cost (¢/1000gal)	Total Upgrade Cost @ 3% (¢/1000gal)
1.8	0.33	15	24	0.33	17	26	0.74	17	37
4.8	0.33	6.3	9.2	0.33	8.6	12	0.99	8.6	17
11	0.33	3.9	5.1	0.33	6.0	7.2	1.5	6.0	12
18	0.68	3.3	4.7	0.68	5.3	6.7	4.2	5.3	14
26	0.68	2.9	3.9	0.68	4.8	5.8	5.6	4.8	13
51	0.76	2.3	2.8	0.76	4.1	4.6	10	4.1	11
210	0.77	1.8	1.9	0.77	3.5	3.6	37	3.5	9.2
430	0.83	1.6	1.7	0.83	3.1	3.2	74	3.1	8.2
520	0.91	1.3	1.4	0.91	2.5	2.6	90	2.5	7.2

**TABLE 7-13 (cont.)  
ESTIMATED INSTALLATION AND UPGRADE COSTS  
FOR CHLORINE DIOXIDE AS PRIMARY DISINFECTANT  
(AUTOMATIC GENERATOR)**

**LARGE SYSTEMS**

Design Flow (mgd)	Log Inactivation = 1			Log Inactivation = 3			Log Inactivation = 5		
	Upgrade Capital Cost <sup>(1)</sup> (\$M)	Upgrade O&M Cost (¢/1000gal)	Total Upgrade Cost @ 7% (¢/1000gal)	Upgrade Capital Cost <sup>(1)</sup> (\$M)	Upgrade O&M Cost (¢/1000gal)	Total Upgrade Cost @ 7% (¢/1000gal)	Upgrade Capital Cost <sup>(1)</sup> (\$M)	Upgrade O&M Cost (¢/1000gal)	Total Upgrade Cost @ 7% (¢/1000gal)
1.8	0.33	15	27	0.33	17	29	0.74	17	44
4.8	0.33	6.3	10	0.33	8.6	13	0.99	8.6	21
11	0.33	3.9	5.7	0.33	6.0	7.7	1.5	6.0	14
18	0.68	3.3	5.0	0.68	5.3	7.0	4.2	5.3	17
26	0.68	2.9	4.4	0.68	4.8	6.4	5.6	4.8	16
51	0.76	2.3	2.7	0.76	4.1	4.7	10	4.1	13
210	0.77	1.8	2.2	0.77	3.5	4.2	37	3.5	12
430	0.83	1.6	2.1	0.83	3.1	3.1	74	3.1	10
520	0.91	1.3	1.4	0.91	2.5	2.6	90	2.5	9.1

<sup>(1)</sup> Cost were adjusted to account for an increase in basin contact time from the information reported in Table 7-10

**TABLE 7-13 (cont.)  
ESTIMATED INSTALLATION AND UPGRADE COSTS  
FOR CHLORINE DIOXIDE AS PRIMARY DISINFECTANT  
(AUTOMATIC GENERATOR)**

**LARGE SYSTEMS**

Design Flow (mgd)	Log Inactivation = 1			Log Inactivation = 3			Log Inactivation = 5		
	Upgrade Capital Cost <sup>(1)</sup> (\$M)	Upgrade O&M Cost (¢/1000gal)	Total Upgrade Cost @ 10% (¢/1000gal)	Upgrade Capital Cost <sup>(1)</sup> (\$M)	Upgrade O&M Cost (¢/1000gal)	Total Upgrade Cost @ 10% (¢/1000gal)	Upgrade Capital Cost <sup>(1)</sup> (\$M)	Upgrade O&M Cost (¢/1000gal)	Total Upgrade Cost @ 10% (¢/1000gal)
1.8	0.33	15	30	0.33	17	32	0.74	17	51
4.8	0.33	6.3	11	0.33	8.6	14	0.99	8.6	24
11	0.33	3.9	6.1	0.33	6.0	8.1	1.5	6.0	16
18	0.68	3.3	5.5	0.68	5.3	7.5	4.2	5.3	21
26	0.68	2.9	4.7	0.68	4.8	6.7	5.6	4.8	19
51	0.76	2.3	2.9	0.76	4.1	4.9	10	4.1	16
210	0.77	1.8	2.2	0.77	3.5	4.2	37	3.5	13
430	0.83	1.6	2.1	0.83	3.1	3.1	74	3.1	12
520	0.91	1.3	1.4	0.91	2.5	2.7	90	2.5	11

<sup>(1)</sup> Cost were adjusted to account for an increase in basin contact time from the information reported in Table 7-10

## B.2 References

1. USEPA. 1998a. Technologies and Costs for Control of Disinfection By-Products. Washington, DC.
2. USEPA. 1998b. *Regulatory Impact Analysis for the Stage 1 Disinfectant/Disinfection Byproduct Rule*. Prepared by Science Applications International Corporation for the USEPA, Office of Ground Water and Drinking Water, Washington, DC.

THIS PAGE INTENTIONALLY LEFT BLANK